

## TERMOSTATSKI VENTIL M sredinski priklop talni

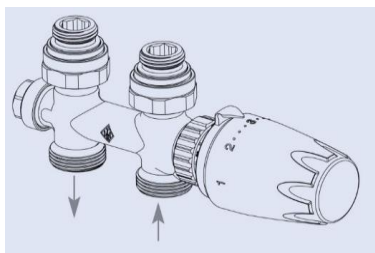

Koda				Cena
Z-D023	bel	ravni ventil	*	76,01
Z-D024	krom	ravni ventil	*	95,89

## TERMOSTATSKI VENTIL M sredinski priklop stenski

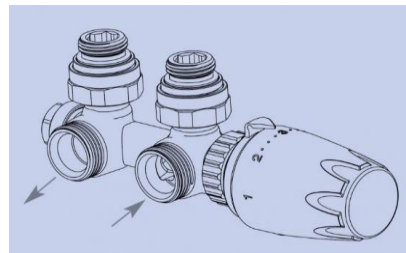

Koda				Cena
Z-D025	bel	kotni ventil		80,89
Z-D026	krom	kotni ventil		99,55

## POKROV ZA TERMOSTATSKI VENTIL M



Koda		Cena
Z-D027	bel	4,79

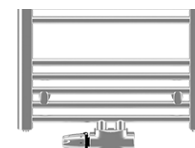

Koda		Cena
Z-D028	krom	5,49

## ELEKTRIČNI GRELCI ZA KOPALNIŠKE RADIATORJE KORALUX brez temperaturnega regulatorja

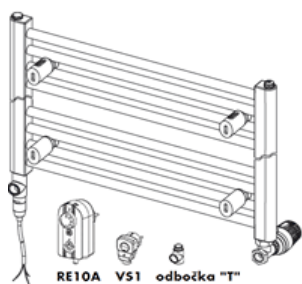

Koda	Moč (W)			Cena
Z-KT7-0300-10	300	bel	*	73,08
Z-KT7-0600-10	600	bel	*	75,76
Z-KT7-0700-10	700	bel	*	75,76
Z-KT7-0800-10	800	bel	*	78,81
Z-KT7-0900-10	900	bel	*	78,81
Z-KT7-1000-10	1000	bel	*	78,81

## ELEKTRIČNI GRELCI ZA KOPALNIŠKE RADIATORJE KORALUX s temperaturnim regulatorjem

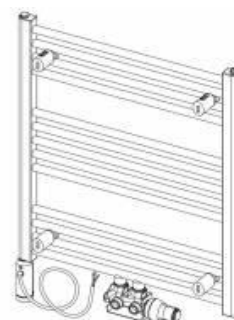

Koda	Moč (W)			Cena
Z-KT7R-0300-10	300	bel	*	219,11
Z-KT7R-0300-27	300	krom	*	236,92
Z-KT7R-0600-10	600	bel	*	222,16
Z-KT7R-0600-27	600	krom	*	240,22
Z-KT7R-0700-10	700	bel	*	222,16
Z-KT7R-0700-27	700	krom	*	240,22
Z-KT7R-0800-10	800	bel	*	225,70
Z-KT7R-0800-27	800	krom	*	245,46
Z-KT7R-0900-10	900	bel	*	225,70
Z-KT7R-0900-27	900	krom	*	245,46
Z-KT7R-1000-10	1000	bel	*	225,70
Z-KT7R-1000-27	1000	krom	*	245,46

## RADIATORSKE KONZOLE C stenska montaža

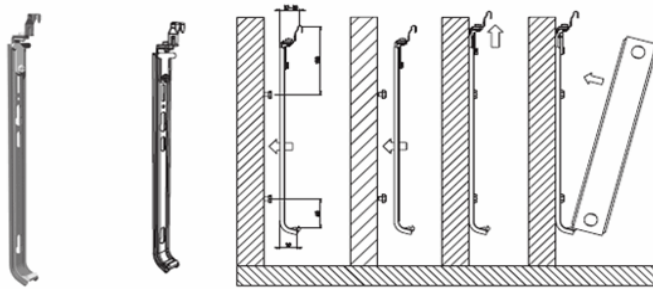

Koda	Dimenzije (mm)	Pakiranje	Cena
<b>C300</b>	300	2 kosa	<b>5,43</b>
<b>C400</b>	400	2 kosa	<b>5,49</b>
<b>C500</b>	500	2 kosa	<b>5,61</b>
<b>C600</b>	600	2 kosa	<b>5,86</b>
<b>C700</b>	700	2 kosa	<b>6,10</b>
<b>C900</b>	900	2 kosa	<b>6,41</b>

Konzola za vse tipe radiatorjev brez ušesc, konzola drži zgornji in spodnji rob radiatorja preko rešetke.  
V kompletu 2x konzola, 2x sidni vložek Ø10, 2x vijak M8 x 70.

## RADIATORSKE KONZOLE H stenska montaža

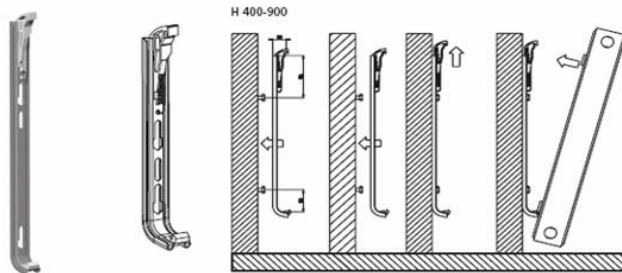

Koda	Dimenzije (mm)	Pakiranje	Cena
<b>H300</b>	300	2 kosa	<b>5,12</b>
<b>H400</b>	400	2 kosa	<b>5,19</b>
<b>H500</b>	500	2 kosa	<b>5,31</b>
<b>H600</b>	600	2 kosa	<b>5,43</b>
<b>H900</b>	900	2 kosa	<b>5,92</b>

Konzola za vse tipe radiatorjev z ušesci, plastično držalo se ob pritisku radiatorja samodejno zaskoči,  
v kompletu 2x konzola, 2x sidni vložek Ø10 in 2x vijak M8 x 70.

## RADIATORSKE KONZOLE T talna montaža

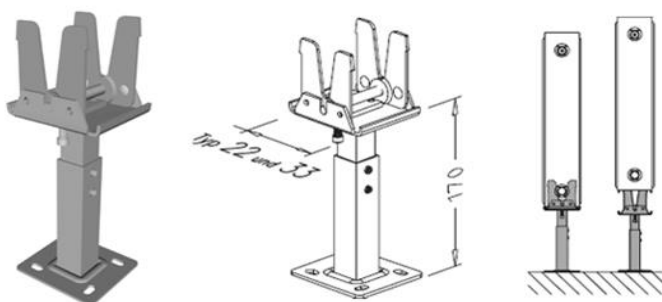

Koda		Cena
<b>T1</b>	1 kos	<b>16,17</b>
<b>T2</b>	1 kos	<b>16,17</b>

Konzola za talno montažo,  
cena za 1 kos, v kompletu  
4 x sidni vložek, 4 x vijak M8x60

## OBEŠALA ZA BRISAČE - (za vse modele KORALUX razen STANDARD)

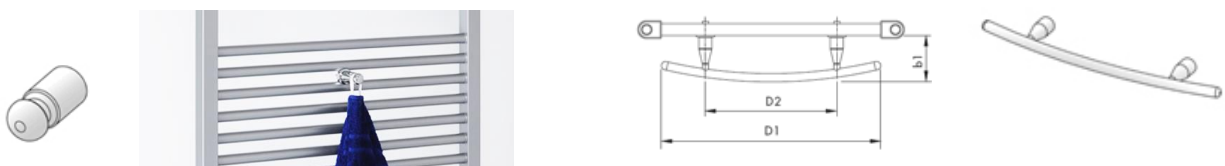

Koda		Cena
<b>Z-D037</b>	krom *	<b>22,33</b>

Koda	D1 / D2 / b1		Cena
<b>Z-D033</b>	krom 370 / 222 / 78	*	<b>82,72</b>
<b>Z-D034</b>	krom 518 / 370 / 93	*	<b>87,84</b>

## BARVE RADIATORJEV

Standardna barva radiatorjev je bela RAL 9016. Doplačilo za izbrano barvo radiatorjev iz prikazane skale barv je +20%. Doplačilo za katerokoli drugo barvo po lastni izbiri po RAL barvni lestvici je 40%. Barvna skala radiatorjev je dostopna na [www.korado.com](http://www.korado.com).

