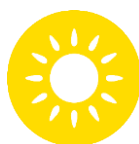

**2024****APRIL**

Cenjene kupce prosimo,  
da zaradi pogostih sprememb cen  
le-te preverijo neposredno  
na navedenih telefonskih številkah.

**PILREMAG d.o.o.****[www.pilremag.si](http://www.pilremag.si)****[komerciala@pilremag.si](mailto:komerciala@pilremag.si)**

Brezje pri Grosupljem 34

tel. komerciala: + 386 1 78 63 983

1290 Grosuplje

tel. trgovina: + 386 (0) 59 11 2000

# vsebina

CENIK JE NAMENJEN INTERNI UPORABI IN POSLOVNIM PARTNERJEM PODJETJA. Cenik velja do spremembe cen. Cene so v evrih in vključujejo 22% DDV. PILREMGAG si pridržuje pravico do spremembe cen, ki so dostopne na [www.pilremag.si](http://www.pilremag.si). Nekatere slike so simbolične. PILREMGAG si pridržuje pravico do tehničnih in optičnih sprememb. Informacije o stanju zaloge artiklov na: [komericiala@pilremag.si](mailto:komericiala@pilremag.si)

OGREVANJE	Blagovna znamka	Cena velja od:	Stran
KOTLI NA LESNE PELETE	TERMOMONT	1.03.2024	NOVO 3
KOTLI NA PELETE	GALMET	1.11.2022	4
KOTLI NA TRDA GORIVA	MODRATHERM	1.12.2021	5
PELETNI GORILNIKI	PELLTECH	1.10.2022	6
KAMINI	HAAS & SOHN	10.6.2023	7
OLJNI KOTLI	DOMUSA	1.7.2021	9
DIMNIKI IZ NERJAVEČE PLOČEVINE ENOSLOJNI	JEREMIAS	24.4.2023	11
DIMNIKI IZ NERJAVEČE PLOČEVINE TROSLOJNI	JEREMIAS	24.4.2023	16
DIMNIKI IZ PVC ZA PLINSKE KONDENZACIJSKE KOTLE	JEREMIAS	24.4.2023	19
DIMNIKI KOAKSIALNI ZA PLINSKE KONDENZACIJSKE KOTLE	JEREMIAS	24.4.2023	21
DIMNIKI IZ ČRNE PLOČEVINE	JEREMIAS	20.10.2022	22
DIMNIKI IZ ČRNE PLOČEVINE ZA PELETNE KAMINE	JEREMIAS	24.4.2023	23
VENTILATORJI DIMNIH PLINOV	PELLTECH	1.1.2021	24
ČIŠČENJE KOTLOV, KAMINOV IN DIMNIKOV	UAB HANSA	1.11.2022	25
ELEKTRIČNI KOTLI	ECOTHERMAL	1.6.2023	26
TOPLOTNE ČRPALKE ZA OGREVANJE	GALMET	1.11.2022	27
TOPLOTNE ČRPALKE ZA OGREVANJE	MIDEA	10.11.2022	29
TOPLOTNE ČRPALKE ZA OGREVANJE	HOT-JET	1.4.2023	31
KOMBINIRANI TLAČNI BOJLERJI	GALMET	1.4.2023	37
ELEKTRIČNI GRELCI ZA BOJLERJE	VOLUX	1.4.2023	40
BOJLERJI IN ZALOGOVNIKI	GALMET	4.9.2023	41
BOJLERJI IN ZALOGOVNIKI	GOLD LEON	1.4.2023	41
BOJLERJI IN ZALOGOVNIKI	SUNSYSTEM	1.1.2024	NOVO 42
RAZTEZNE POSODE	REFLEX	1.2.2023	46
OBTOČNE ČRPALKE	AVANSA	18.4.2023	50
KOTLOVSKA REGULACIJA	BRV	15.11.2021	51
KOTLOVSKA REGULACIJA	REGULUS	10.4.2024	NOVO 52
REGULACIJA ZA OGREVANJE IN HLAJENJE	SALUS	1.1.2023	54
REGULACIJA ZA OGREVANJE IN HLAJENJE	ENGO	1.1.2023	61
SOBNI TERMOSTATI	FRONTIER	20.3.2023	63
SOBNI TERMOSTATI	ELEKTROBOCK	20.3.2023	63
SONČNI KOLEKTORJI	ENSOL	15.7.2023	64
FLEKSIBILNE CEVI ZA SONČNE KOLEKTORJE	ALVEOFLEX	24.4.2023	64
RADIATORJI RADIK KLASIK	KORADO	1.7.2022	65
RADIATORJI RADIK VK, VKU	KORADO	1.7.2022	67
RADIATORJI RADIK VKM8	KORADO	1.7.2022	69
RADIATORJI RADIK LINE VERTIKAL-M	KORADO	1.9.2022	71
RADIATORJI RADIK PLAN VERTIKAL-M	KORADO	1.9.2022	72
RADIATORJI KORATHERM	KORADO	1.7.2022	73
RADIATORJI KORALUX NEO	KORADO	11.1.2023	79
RADIATORJI KORALUX KOPALNIŠKI	KORADO	1.12.2022	80
RADIATORJI P.THERMAL KOPALNIŠKI	PUCIHAR	8.9.2022	82
OPREMA ZA RADIATORJE	KORADO	1.3.2023	83
OPREMA ZA RADIATORJE ELEKTRIČNI GRELCI	VOLUX	10.4.2024	NOVO 83
RADIATORSKI VENTILI	J.SCHLOSSER ARMATUREN	1.1.2021	85
RAZDELILCI ZA TALNO OGREVANJE	ONDA	20.5.2023	86
RAZDELILNE OMARICE ZA TALNO OGREVANJE	ECOTHERMAL	1.4.2024	NOVO 87
TALNO OGREVANJE CEVI	ISOLTUBEX	20.5.2023	87
TOPLOVODNI KALORIFERJI	VTS EUROHEAT	1.12.2022	88
ZRAČNE ZAVESE	VTS EUROHEAT	1.12.2022	90
<b>PREZRAČEVANJE IN HLAJENJE</b>			
REKUPERACIJA	AERAULIQA	1.6.2023	93
PREZRAČEVALNI DIFUZORJI	ERGOVENT	1.1.2023	102
REKUPERACIJA	OVA	1.6.2023	103
REKUPERACIJA	AWENTA PRO	1.10.2023	104
VENTILATORJI	AIRFLOW	6.02.2024	106
VENTILATORJI	AERAULIQA	15.2.2023	107
VENTILATORJI	EUROPLAST	1.2.2023	109
DISTRIBUCIJA ZRAKA	EUROPLAST	1.3.2024	112
VGRADNA VRATCA	EUROPLAST	1.2.2023	121
KLIMATSKE NAPRAVE	MIDEA	15.4.2024	NOVO 122
ČISTILA ZA OGREVALNE IN HLADILNE SISTEME	CHQUIMICA	15.4.2024	NOVO 123
CEVNE OBJEMKE, NOSILCI, VIJAKI	SOLIDA	12.10.2023	124
<b>VODOVOD IN KANALIZACIJA</b>			
ALUMPLAST PERT-AL-PERT PRESS	ISOLTUBEX	1.12.2022	131
ALUMPLAST PERT-AL-PERT VIJAČNI	ISOLTUBEX	1.6.2022	134
VODOVODNE ALKATEN CEVI IN FITINGI PE	VALDOM	1.4.2024	NOVO 135
VODOVODNE CEVI IN FITINGI PP-R	VALDOM	5.4.2024	NOVO 137
FILTRI IN MEHČALCI VODE	ATLAS	1.11.2022	139
KANALIZACIJA	HULIOT	1.6.2023	141
KANALIZACIJA	PLASTBRNO	1.6.2023	144
PREZRAČEVALNI VENTILI ZA KANALIZACIJO	DURGO	1.4.2023	152
ODTOČNE CEVI IN MANŠETE	PLASTBRNO	1.6.2023	153
SIFONI	PLASTBRNO	1.4.2024	NOVO 154
ODTOČNE TUŠ KANALETE	PLASTBRNO	1.4.2024	NOVO 157
TUŠ KADI	RIHO	15.1.2024	162
TUŠ KABINE	RIHO	15.1.2024	163
KOPALNE KADI	RIHO	15.1.2024	164
SANITARNA OPREMA	KERAMIKA LESKOVAC	23.2.2023	165
ARMATURE	PAFFONI	1.4.2023	168
KOPALNIŠKI DODATKI	NIMCO	21.3.2023	171
KOPALNIŠKI DODATKI ZA STAROSTNIKE / INVALIDE	K-DESIGN	9.10.2023	174
ELEKTRIČNA IN IR GRELNA TELESA	EKODOM	23.3.2023	175

## KOMPAKTNI KOTEL NA LESNE PELETE B-Smart 9 - 30kW (nastavljiv)



### KOTEL Z ZADNJE STRANI

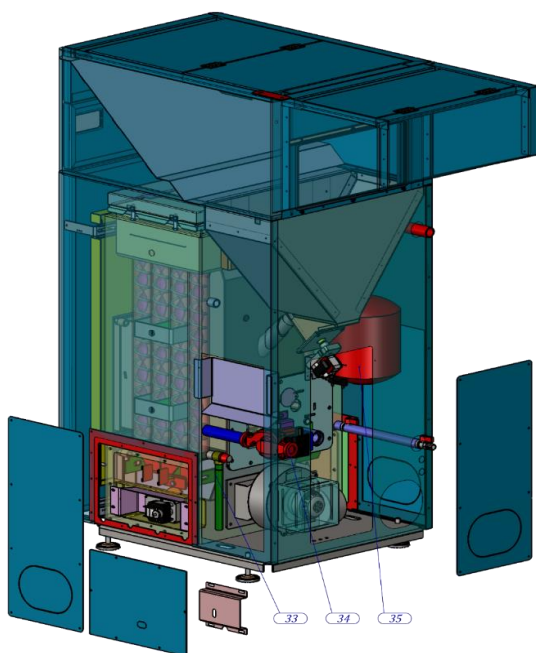

- 33) Varnostni ventil
- 34) Obtočna črpalka
- 35) Raztezna posoda 8L

Koda	Naziv	Moč (kW)	Cena
<b>B-SMARTE 30</b>	Kotel na pelete B-Smart	9 - 30	<b>3.257,40</b>

Kotli B-Smart za kurjenje na lesne pelete so zasnovani za postavitev v manjše prostore in ustrezajo manjšim prehodom. Gorilnik je preiščljeno zasnovan (lastna izvirna rešitev zaščitena v Evropskem registru modelov EUIPO) in zagotavlja dodaten prihranek. B-Smart zalogovnik za pelete se montira na kotel na licu mesta. Vžig, zagon in izklop so popolnoma avtomatizirani. Izgorevanje nadzira algoritem v modulu, ki avtomatsko uravnava doziranje peletov glede na željeno in doseženo temperaturo. Izdelan je po standardu EN 303-5 in izpolnjuje stroga okoljska merila Evropske Direktive (Ecodesign criteria 2015:1189). Kotel lahko kurite le s kvalitetnimi peleti razreda EN 14961, A1 ali A2, premera 6mm ali 8mm. Obvezno je vgraditi termometer, manometer, izpustni termični ventil, termostatski mešalni ventil za varovanje povratka in odzračevalni lonček. Priporočljivo je vgraditi dodatno raztezno posodo.

Wi-fi regulacija omogoča servisno podporo in upravljanje kotla preko aplikacije.

### Tehnični podatki

Tip kotla	Eco Boiler CG7*
Nazivna moč	30 KW
Moč	9-30 KW
Temperaturni razpon	60- 80 °C
Najmanjša temperature povratnega voda	50 °C
Poraba goriva pri najmanjši moči	min 1,8 kg/h
Poraba goriva pri največji moči	max 6 kg/h
Peleti - razred kvalitete	A1, A2 Ø6, Ø8
Teža kotla	245 kg
Najvišji delovni tlak	2,5 bar
Volumen zalogovnika pelet	150 l
Volumen podaljšanega zalogovnika pelet	230 l
Priključni vod / Povratni vod	1"
Polnjenje / praznjenje	1/2"
Odvod dimnih plinov premer	120 mm
Dovod zraka	50 mm
Izhodna temp. dimnih plinov	140 °C
Min. vlek dimnika	10 Pa
Volumen vode v kotlu	58 l
Napajanje	220 V 50 Hz
Poraba el. energije pri zagonu	400 W
Poraba el. energije pri delovanju	100 W
Razred učinkovitosti kotla	5
Razred emisij kotla	5

Emisije v ogrevalni sezoni	mg/m <sup>3</sup> <sub>n</sub> (sur 10% O <sub>2</sub> )
CO	70
OGC	1
Dust	19.2
NOx	148
Sezonska učinkovitost	80%
Razred energetske učinkovitosti	<b>A+</b>

## KURILNA NAPRAVA NA PELETE Z ROTACIJSKIM GORILNIKOM (samočistilni) GALMET



Koda	Naziv	*Odprodaja	Moč (kW)	Cena
<b>07-105300*</b>	GENESIS PLUS KPP 10	kotel na pelete	11	<b>3.318,40</b>
<b>07-155300*</b>	GENESIS PLUS KPP 15	kotel na pelete	15	<b>3.403,80</b>
<b>07-205300*</b>	GENESIS PLUS KPP 20	kotelč na pelet	20	<b>3.702,70</b>

### IZKORISTEK DO 97%

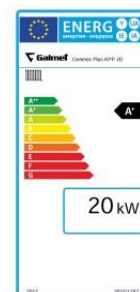
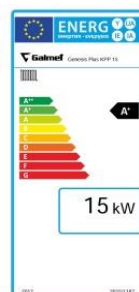
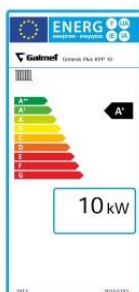

TEHNIČNI PODATKI	Enote	Genesis Plus KPP 10	Genesis Plus KPP 15	Genesis Plus KPP 20
Nazivna moč	kW	11	15	20
Območje moči	kW	3,4 ÷ 10,9	4,5 ÷ 15,2	5,6 ÷ 19,4
Razred kotla (EN 303-5:2012)		5	5	5
Ogrevalna površina kotla	m <sup>2</sup>	1,66	2,08	2,63
Vrsta goriva	Lesni peleti, velikost zrn 6+8 mm			
Razred goriva	A1 EN 14961-2			
Velikost posode za pelete	l		180	180
Pretok goriva (pri max. obremenitvi)	kg/h	2,36	3,5	4,19
Čas ogrevanja ob enem polnjenju pri naz. moči	h	76,27	51,42	42,95
Izkoristek	%	96,56	96,75	97,01
Zahtevani vlek dimnika	mBar	0,16	0,2	0,24
Minimalna višina dimnika	m	6	6	6
Minimalni prerez dimnika	mm	fi 160	fi 160	fi 160
Temperatura dimnih plinov pri naz. moči	°C	75,5	74,2	72,4
Temperatura dimnih plinov pri min.moči	°C	62,8	63,1	63,4
Tok dimnih plinov pri nazivni moči	kg/s	0,0065	0,0080	0,0096
Tok dimnih plinov pri minimalni moči	kg/s	0,0031	0,0038	0,0045
Padec tlaka v kotlu	mBar	15	15	15
Območje delovne temperature	°C	55+85	55+85	55+85
Max. temperatura dviznega voda	°C	85	85	85
Min. temperatura povratnega voda	°C	55	55	55
Volumen kurišča	l	37,5	37,5	37,5
Dovoljen delovni tlak	bar	2	2	2
Prostornina posode za vodo v kotlu	l	46	68	90
Masa kotla z gorilcem (brez podajal. in zalog.)	kg	220	243	272
Masa zalogovnika za pelete	kg	30	30	30
Zunanji premer dimne odprtine	mm	Ø 133	Ø 159	Ø 159
Premer priključkov dviz. / povr. voda	"	1,25	1,25	1,25
Premer priključka za dodatni izpust	"	0,5	0,5	0,5
Višina-širina-globina kotla	mm	970-595-1090	970-595-1090	970-595-1090
Višina dimnega priključka	mm	721	688	688
Poraba električne energije	W	13,1	24,7	27,4
Poraba električne energije v mirovanju	W	9	9	9
Priključna napetost kotla / zaščita	230V~/50Hz, 6,3A/250V~			
Nivo zaščite	IP	40	40	40
Nivo hrupa (EN ISO 12100:2010)	dB	<60	<60	<60
Deluje z ventilatorjem	da (v gorilniku)			
Emisijski razred kotla	PN-EN 303-5:2012	5	5	5
Napajanje	AC 230V / 50HZ / 6A			
Poraba energije	W	24,7	24,7	24,7
Električna zaščita	EN 60335 - 1 EN 60335 - 2 102			
Stopnja zaščite	IP	40	40	40

## PYROGAS uplinjevalni kotel za kurjenje lesne biomase in briketov



Koda	Naziv		Cena
<b>PYROGAS22</b>	PYROGAS 22	lambda sonda	<b>5.106,92</b>
<b>PYROGAS26</b>	PYROGAS 26	lambda sonda	<b>5.172,80</b>
<b>PYROGAS28</b>	PYROGAS 28	lambda sonda	<b>5.868,20</b>
<b>PYROGAS37</b>	PYROGAS 37	lambda sonda	<b>6.319,60</b>
<b>PYROGAS45</b>	PYROGAS 45	lambda sonda	<b>6.362,30</b>

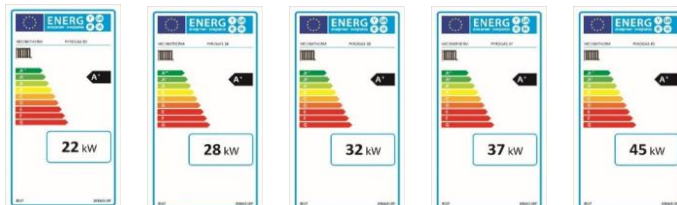

### SUBVENCIJA EKO SKLADA

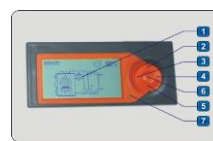

Elektronski krmilnik omogoča nadzor in dostop do varnostnih funkcij. Servomotor Belimo je nameščen na loputi za dovod sekundarnega zraka.

## TEHNIČNI PODATKI

Tip kotla	enota	PYROGAS 26	PYROGAS 28	PYROGAS 37	PYROGAS 45
<b>Izhodna moč</b>	kW	27	32	37	45
<b>Razred kotla (STN EN 303-5)</b>		5	5	5	5
<b>Priporočeno gorivo (STN EN 303-5)</b>	les A / lesni briketi C2, maks. stopnja vlage 20%				
<b>Izkoristek</b>	%	89 - 92	89 - 92	89 - 92	89 - 92
<b>Kapaciteta vode</b>	l	80	108	118	118
<b>Povprečna temp. dimnih plinov</b>	°C	136 – 160	136 – 160	136 – 160	136 – 160
<b>Min. temp. povratnega voda</b>	°C	65	65	65	65
<b>Maks. delovni tlak / delovni tlak</b>	bar	2,5 / 1,6	2,5 / 1,6	2,5 / 1,6	2,5 / 1,6
<b>Maks. delovni tlak varnostnega izmenjevalca</b>	bar	6	6	6	6
<b>Volumen zgorevalne komore</b>	l	108	147	187	187
<b>Dimenzije kotla (š x v x d)</b>	mm	530 x 1260 x 1000	530 x 1260 x 1200	530 x 1430 x 1200	530 x 1430 x 1200
<b>Vlek dimnika</b>	Pa	22 – 24	23 – 25	23 – 25	23 – 25
<b>Celotna teža</b>	kg	425	520	566	581
<b>Dimenzije posode za pepel (š x v x d)</b>	mm	380 x 70 x 520	380 x 70 x 720	380 x 70 x 720	380 x 70 x 720
<b>Dimenzije nalagalne odprtine (š x v x d)</b>	mm	390 x 490	390 x 490	390 x 510	390 x 510
<b>Premer dimne odprtine</b>	mm	152	152	152	152
<b>Napajanje / frekvenca</b>	V / Hz	230 / 50	230 / 50	230 / 50	230 / 50
<b>Vhodna električna moč</b>	W	50	50	50	50
<b>Zaščita IP</b>	IP	40	40	40	40
<b>Princip delovanja</b>	Kotel obratuje v pogojih vakuumu (podtlak)				

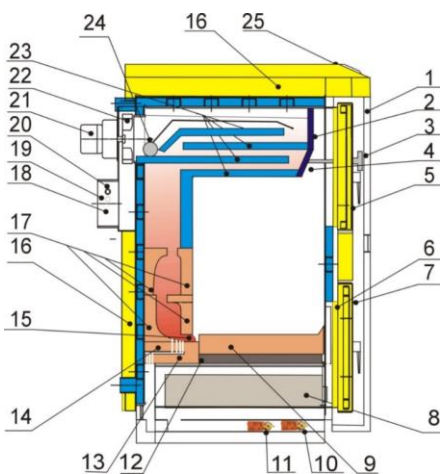

## SESTAVA KOTLOV

1. Pot dimnih plinov	13. Rešetka iz litega železa	25. Primarna šoba iz ognjevarnega betona
2. Okvir	14. Posoda za pepel	26. Izgorevalna komora iz ognjevarnega betona LACFIRE
3. Prednja stranica	15. Ploskovni usmerjevalnik	27. Navpične vodne lamele
4. Odstranljiva stranica okvirja	16. Stranici iz ognjevarnega materiala	28. Izhod za dimno cev
5. Matica lopute vleka	17. Servomotor sekundarnega zraka Belimo	29. Temperaturno zaznavalo dimnih plinov
6. Loputa vleka	18. Servomotor primarnega zraka Belimo	30. Lambda sonda Bosch
7. Vrata za nalaganje goriva	19. Pokrov rešetke iz litega železa	31. Sesalni ventilator EBM-PAPST
8. Izvlečna opeka toplotne zaščite	20. Podnožje	32. Propeler sesalnega ventilatorja
9. Opeka iz ognjevarnega materiala	21. Vložki rešetke iz ognjevarnega materiala	33. Elementi toplotnega izmenjevalnika - lamele
10. Vrata rešetke	22. Nastavek izgorevalne komore iz ognjevarnega betona	34. Usmerjevalnik dimnih plinov
11. Spodnja čistilna vrata	23. Nosilec izgorevalne komore	35. Toplotna izolacija
12. Prednja opeka iz ognjevarnega materiala	24. Opeka za sekundarni zrak iz ognjevarnega betona	36. Mikroprocesorski krmilnik AK5000

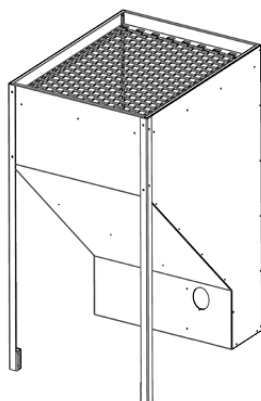
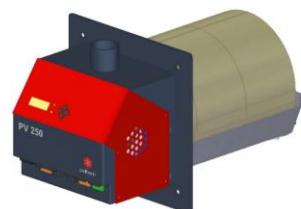

## PELETNI GORILNIKI PELLTECH 20kW, 30kW, 50kW

Koda	Naziv	*odprodaja	Cena
PV0021	Peletni gorilnik PV 20a - 20 Kw		1.281,00
PV0031	Peletni gorilnik PV 30a - 30 kW		1.403,00
PV0022	Peletni gorilnik PV 20b - 20 kW samočistilni		1.586,00
PV0032	Peletni gorilnik PV 30b - 30 kW samočistilni		1.708,00
PV0053	Peletni gorilnik PV 50c - 50 kW samočistilni		2.318,00

## PELETNI GORILNIKI PELLTECH od 100kW do 1000kW

Koda	Naziv	Cena
PV0104	Avtomatski samočistilni gorilnik PV 100d - 100kW	3.294,00
PV0184	Avtomatski samočistilni gorilnik PV 180d - 180kW	4.514,00
PV0353	Peletni gorilnik PV 350b - 350 kW	10.980,00
PV0502	Peletni gorilnik PV 500a - 500 kW	14.640,00
PV0701	Peletni gorilnik PV 700a - 700 kW	18.300,00
PV1001	Peletni gorilnik PV 1000a - 1000 kW	24.400,00

## PELETNI POLŽ PELLTECH 20kW, 30kW, 50kW, 100kW, 1000kW

Koda	Naziv	Cena
PA1525	Peletni polž 1500 mm za 25 W - PV 20a/b, 30a/b, 50b	280,60
PA2025	Peletni polž 2000 mm za 25 W - PV 20a/b, 30a/b, 50b	292,80
PA3025	Peletni polž 3000 mm za 40W - PV 20a/b, 30a/b, 50b	475,80
PA1545	Peletni polž 1500 mm PV 100b	317,20
PA2045	Peletni polž 2000 mm PV 100b	348,92
PA2047	Peletni polž 2000 mm PV 180b	475,80
PA4047	Peletni polž 4000 mm PV 100b/180b	890,60
PA4037	Peletni polž 4000 mm 700kW - PV200a	1.098,00
PA6097	Peletni polž 6000 mm bold PV 100b/180b	1.061,40

## ZALOGOVNIK ZA PELETE

Koda	Naziv	Cena
ZAL55	Zalogovnik za pelete 55 x 90 x 122cm (200kg)	341,60
ZAL65	Zalogovnik za pelete 65 x 85 x 122cm (250kg)	353,80

Pocinkana pločevina

Vsa ponudba kaminov HAAS + SOHN je dostopna na [www.pilremag.si](http://www.pilremag.si) - SPLETNA TRGOVINA - OGREVANJE

Naziv	WIEN easy 351.15	PYRUS 294.15-ST
Koda	0335115100000	0429415100000
Nazivna toplotna moč	6kW	6kW
Teža	116kg	169kg
Učinkovitost	80%	82%
Razred energijske učinkovitosti	<b>A</b>	<b>A+</b>
Višina / širina / dolžina	1215/482/380	1004 / 540 / 477mm
Vratca kurišča višina / širina	370/400	280 / 300mm
Kurišče višina /širina / globina	470/375/230	341 / 300 / 290mm
Premer dimniškega priključka	150mm	150mm
Višina dimniškega priključka (sredina)	1089	781mm
Emisijske vrednosti dimnih plinov (g/s °C Pa)	5,4/365/12	5,4 / 300 / 12 - 10
Jeklo obdelava	črna	pearl črna, Woodstone Prestige
Keramika		
<b>Cena</b>	<b>2.469,91</b>	<b>2.561,44</b>



Naziv	ARUBA easy 220.17- ST	TIROL 343.15-C
Koda	0422017080000	0434350010000
Nazivna toplotna moč	3-6kW	6kW
Teža	182kg	111kg
Učinkovitost	80%	80%
Razred energijske učinkovitosti	<b>A+</b>	<b>A+</b>
Višina / širina / dolžina	1030 / 700 / 365mm	956 / 668 / 356mm
Vratca kurišča višina / širina	340 / 350mm	213 / 280mm
Kurišče višina /širina / globina	410 / 360 / 220mm	270 / 325 / 240mm
Premer dimniškega priključka	150mm	130mm
Višina dimniškega priključka (sredina)	845mm	zgoraj
Emisijske vrednosti dimnih plinov (g/s °C Pa)	6,2 / 294 / 11	5,9 / 343 / 12
Jeklo obdelava	pearl črna	črna
Keramika	siv kamen-peskan	barvne pečnice (več možnosti)
<b>Cena</b>	<b>2.871,12</b>	<b>2.096,29</b>

Vsa ponudba kaminov HAAS + SOHN je dostopna na [www.pilremag.si](http://www.pilremag.si) - SPLETNA TRGOVINA - OGREVANJE

Naziv	HSP 2.17 Selina	HSP 6 WT 537.08 RLU	HSP 6 WT hidravlični modul
	Peletni kamin	Peletna kaminska peč za centralno ogrevanje	za peletno kaminsko peč
Koda	<b>0571407130000</b>	<b>0553708050000</b>	<b>0553808114000</b>
Nazivna toplotna moč	2,4-8,6kW	10kW	
Teža	90kg	176kg	4kg
Učinkovitost	90%	93%	
Razred energijske učinkovitosti	<b>A+</b>	<b>A++</b>	<b>G</b>
Višina / širina / dolžina	966 / 498 / 511mm	1200 / 544 / 498mm	
Kurišče kapaciteta kg	17kg	30kg	
Premer dimniškega priključka	80mm	80mm	
Višina dimniškega priključka (sredina)	270mm	250mm	
Emisijske vrednosti dimnih plinov (g/s °C Pa)	5,7 / 198 / 11	7,4 / 152 / 12	
Jeklo obdelava	pearl črna	pearl antracit /bela	
Opcije	Možnost Wi-fi regulacije	Možnost Wi-fi regulacije	
<b>Cena</b>	<b>3.446,59</b>	<b>5.859,64</b>	<b>718,40</b>



Naziv	LONDON-II EASY BACK 347.15	HSPH 75.5-SF easy
	Kamin na drva s pečico	Štedilnik na drva
Koda	<b>0434715300000</b>	<b>07075522340000</b>
Nazivna toplotna moč	8kW	8kW
Teža	194kg	135kg
Učinkovitost	80%	80%
Razred energijske učinkovitosti	<b>A+</b>	<b>A+</b>
Višina / širina / dolžina	1226 / 694 / 464mm	850-880 / 750 / 600mm
Vratca kurišča višina / širina	250 / 500mm	200 / 175mm
Kurišče višina / širina / globina	300 / 530 / 245mm	250 / 215 / 410mm
Premer dimniškega priključka	150mm	120mm
Višina dimniškega priključka (sredina)	zgoraj	690-710mm
Emisijske vrednosti dimnih plinov (g/s °C Pa)	6,5 / 315 / 12	8,8 / 250 / 12
Jeklo obdelava	pearl antracit	antracit
<b>Cena</b>	<b>3.609,58</b>	<b>3.107,67</b>

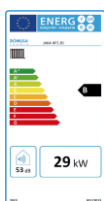

## OLJNI KOTEL JAKA HFS (brez gorilnika)

**B**

Koda	Priporočni gorilnik	Moč (kW)	Cena
<b>JAKA HFS 30</b>	DOMESTIC D3	28,1	<b>838,73</b>
<b>JAKA HFS 40</b>	DOMESTIC D4	39,4	<b>908,41</b>
<b>JAKA HFS 50</b>	DOMESTIC D4	50,8	<b>1.110,00</b>
<b>JAKA HFS 60</b>	DOMESTIC D6	60,7	<b>1.200,85</b>
<b>JAKA HFS 70</b>	DOMESTIC D6	71,4	<b>1.391,24</b>
<b>JAKA HFS 80</b>	DOMESTIC D10	83,3	<b>1.557,99</b>

## OLJNI GORILNIK DOMESTIC



Koda	Teža (kg)	Moč (kW)	Cena	
<b>DOMESTIC D-3</b>	11,7	17,7 - 36	<b>457,50</b>	
<b>DOMESTIC D-3P</b>	predgretje	11,7	17,7 - 36	<b>513,62</b>
<b>DOMESTIC D-4</b>	11,7	27,2 - 55	<b>467,26</b>	
<b>DOMESTIC D-4P</b>	predgretje	11,7	27,2 - 55	<b>531,92</b>
<b>DOMESTIC D-6</b>	15	52 - 85	<b>530,70</b>	
<b>DOMESTIC D-10</b>	15	70 - 116	<b>685,64</b>	

## KONDENZACIJSKI OLJNI KOTEL HFD

**A**

Koda	Moč (kW)	Cena
<b>JAKA HFD 20 CONDENS</b>	20,3	<b>2.476,36</b>
<b>JAKA HFD 30 CONDENS</b>	30,2	<b>2.961,67</b>

## KONDENZACIJSKI OLJNI KOTEL EVOLUTION

**A**

Koda	Moč (kW)	Cena
<b>EVOLUTION EV 25 HAC</b>	29,3	<b>3.219,26</b>
<b>EVOLUTION EV 35 HAC</b>	40,5	<b>3.552,76</b>

## KONDENZACIJSKI OLJNI KOTEL HFD CONDENS (zunanja montaža)

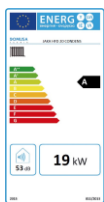
**A**

Koda	Moč (kW)	Cena
<b>JAKA HFD 20 CONDENS OD</b>	20,3	<b>2.974,12</b>
<b>JAKA HFD 30 CONDENS OD</b>	30,2	<b>3.148,33</b>
<b>JAKA HFD 40 CONDENS OD</b>	40,5	<b>3.347,44</b>

## KONDENZACIJSKI OLJNI KOTEL MINNY (vgradnja v kuhinjo)

**A**

Koda	Moč (kW) 80°C/60°C	Cena
<b>MINNY 2D</b>	20	<b>2.961,67</b>
<b>MINNY 3D</b>	30	<b>3.223,00</b>

**Možna vgradnja med kuhinjske elemente.**

## TEHNIČNI PODATKI

	Simbol	Enota	JAKA HFS 30	JAKA HFS 40	JAKA HFS 50	JAKA HFS 60	JAKA HFD20 CONDENS	JAKA HFD30 CONDENS	EVOLUTION EV 25 HAC	EVOLUTION EV 35 HAC
Nazivna toplotna moč	$P_{nazivna}$	kW	29	40	50	60	19	30	27	37
Kondenzacijski kotel			NE	NE	NE	NE	DA	DA	DA	DA
Energijski razred										
Dejanska toplotna moč za ogrevalne in kombinirane kotle:										
Pri nazivni toplotni moči in visokotemperaturnem režimu delovanja	$P_4$	kW	28,1	39,4	50,8	60,7	19	28,7	27,1	37,4
Pri 30% nazivne toplotne moči in nizkotemperaturnem režimu delovanja	$P_1$	kW	8,9	12,1	15,6	18,6	6,1	8,5	8,8	12,2
Dodatna poraba električne energije										
Pri polni obremenitvi	$e_{lmax}$	kW	0,152	0,161	0,161	0,226	0,226	0,226	0,226	0,226
Pri delni obremenitvi	$e_{lmin}$	kW	0,055	0,056	0,056	0,078	0,078	0,078	0,078	0,078
V stanju pripravljenosti	$P_{SB}$	kW	0,003	0,003	0,003	0,001	0,001	0,001	0,001	0,001
Deklarirana obremenitev										
Dnevna poraba električne energije	$Q_{elec}$	kWh								
Energijski izkoristek naprave pri sezonskem ogrevanju	$\eta_s$	%	90	87	86	86	90	91	90	92
Dejanski izkoristek za ogrevalne in kombinirane kotle										
Pri nazivni toplotni moči in visokotemperaturnem režimu delovanja	$\eta_4$	%	86,3	89,3	89,1	89,1	91	92,4	92,1	91,1
Pri 30% nazivne toplotne moči in nizkotemperaturnem režimu delovanja	$\eta_1$	%	92	91,4	90,8	90,8	97,9	97,6	98,1	97,9
Ostali podatki										
Toplotne izgube v stanju pripravljenosti	$P_{stby}$	kW	0,106	0,094	0,141	0,182	0,127	0,135	0,12	0,09
Poraba električne moči vžigalnega grelca	$P_{ign}$	kW								
Emisije dušikovih oksidov	$NO_x$	mg / kWh	126	105	128	133	92	118	114	117
Izkoristek energije pri ogrevanju vode	$\eta_{wh}$	%								
Dnevna poraba kuriva	$Q_{fuel}$	kWh								
Nizkotemperaturni kotel			DA	DA	DA	DA	NE	NE	NE	NE
B1 kotel			NE	NE	NE	NE	NE	NE	NE	NE
Kogeneracijski ogrevalni kotel			NE	NE	NE	NE	NE	NE	NE	NE
Možnost dodatnega grelca			NE	NE	NE	NE	NE	NE	NE	NE
Kombinirani kotel			NE	NE	NE	NE	NE	NE	NE	NE

## ENOSLOJNI DIMNIKI IZ NERJAVEČE PLOČEVINE

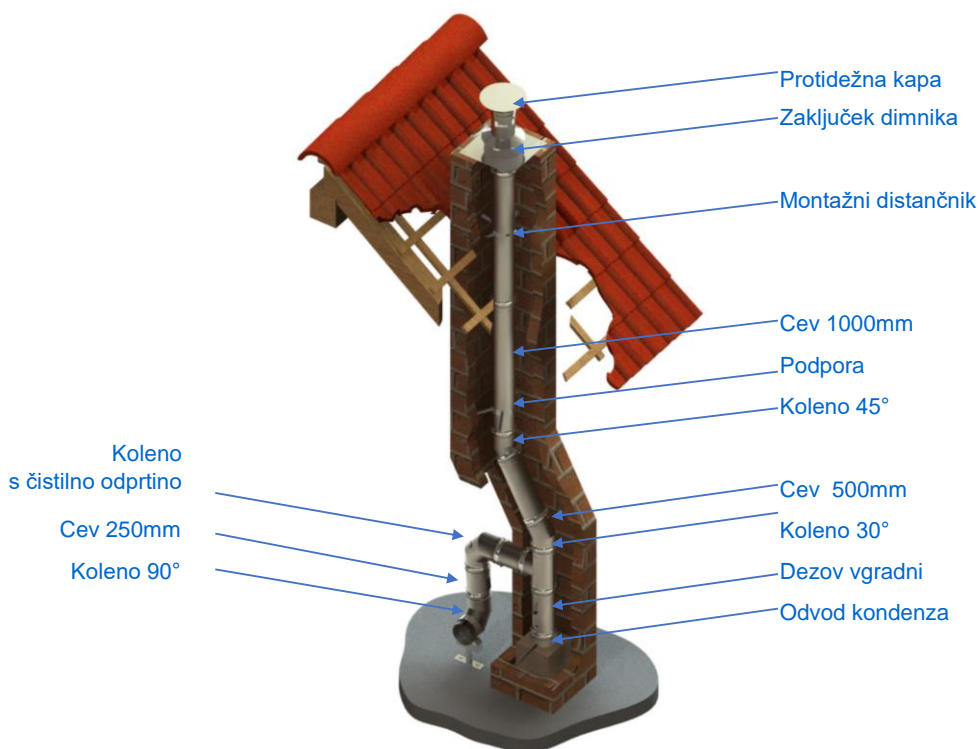

\*Po naročilu

ČISTILNI ELEMENTI	Odvod kondenza 250mm	Dezov vgradni čistilni pokrov 210x140mm	Dezov veliki 210 x 480mm	Podaljšek za dezov	Dezov vgradni revizijski 500mm	Cev z revizijsko odprtino (do 600°C)
Koda	FU01B	FU0607	FU0634	FU11	FU06113	FU0607R
Ø060*	27,25				76,80	
Ø080	27,25	54,00	50,81		76,80	116,31
Ø100	31,48	57,12	50,81		85,17	116,31
Ø110	32,07	57,12	51,29		85,70	168,58
Ø115*	33,17	57,12	51,29		87,84	116,31
Ø120	33,17	59,15	54,02		97,90	122,65
Ø130	33,68	61,32	55,66		100,13	131,13
Ø140	34,49	63,38	56,14	15cm	100,69	133,16
Ø150	35,28	67,66	56,70	31,79	101,79	133,16
Ø160	36,92	69,81	58,84		104,58	141,61
Ø180	38,52	74,03	60,93		105,18	145,95
Ø200	40,69	84,55	69,50		117,94	160,69
Ø225*	41,74	88,77	74,88		121,77	169,09
Ø250	43,37	99,40	86,12		125,24	177,55
Ø300*	48,13	118,39	101,17		149,14	183,92
Ø350*		141,61			192,37	217,73
Ø400*		175,49			205,08	253,72
Ø450*		200,85		50cm	224,10	281,20
Ø500*		219,79		93,03	251,58	310,79



\*Po naročilu

VRATCA T-KOSI	Vratca velika gola	Vratca velika z nastavkom	Vratca velika nihajna 210 x140mm	T- kos 87°	T- kos 45°	T- kos klix 87°
Koda	FU13	FU0960PL	FU35	FU0615	FU0616	FU0649
Ø060*	dim. 210x140 mm	dim. 210x140 mm		34,27	45,01	
Ø080				34,75	45,71	61,80
Ø100			83,08	37,96	51,01	67,95
Ø110	58,34	71,86		40,10	53,88	73,41
Ø115*				42,24	56,87	77,36
Ø120				45,49	58,59	82,29
Ø130				48,67	66,28	86,80
Ø140				50,81	73,81	83,02
Ø150				52,98	81,45	90,66
Ø160				56,93	95,23	99,60
Ø180				60,93	109,04	110,76
Ø200				75,47	126,48	123,52
Ø225*				86,60	151,17	136,85
Ø250				97,85	183,89	153,00
Ø300*				125,13	239,55	175,83
Ø350*					301,04	218,16
Ø400*					310,26	340,33
Ø450*					345,00	
Ø500*					389,00	



\*Po naročilu

CEVI	Cev 1000mm	Cev 500mm	Cev 250mm	Cev 1000mm z zanko za sanacijo	Cev 1000mm z dvojno mufno žiž	Cev 250mm z dvojno mufno žiž
Koda	FU0602	FU0603	FU0604	FU0605	FU0606	FU061879
Ø060*	32,61	17,70	10,68	34,27	36,83	
Ø080	34,27	18,74	11,24	36,33	38,44	15,42
Ø100	43,37	20,85	13,36	44,92	47,51	17,56
Ø110	44,41	23,05	14,46	46,02	48,61	19,11
Ø115*	44,92	24,60	15,50	46,58	49,15	19,70
Ø120	50,81	25,65	17,70	52,45	55,04	21,93
Ø130	52,98	27,79	19,84	54,56	57,18	24,07
Ø140	55,88	29,93	21,36	57,49	60,11	25,62
Ø150	58,84	32,07	23,05	60,51	63,10	27,22
Ø160	67,38	34,27	24,10	69,02	71,67	28,35
Ø180	75,98	36,33	25,19	77,59	80,23	29,42
Ø200	89,79	46,02	27,79	91,48	94,10	32,04
Ø225*	98,38	50,81	31,48	100,02	102,61	35,73
Ø250	115,01	57,77	35,28	116,62	119,18	39,54
Ø300*	131,13	64,68	40,69	132,65	135,27	44,87
Ø350*	183,92	112,05	67,66	188,17	188,17	142,43
Ø400*	228,33	137,42	82,43	232,53	232,53	
Ø450*	274,86	164,89	99,40	279,09	279,09	
Ø500*	319,22	192,37	116,31	323,44	323,44	



\*Po naročilu

KOLENA	Koleno 90°	Koleno 45°	Koleno 30°	Koleno 87° s čistilno odprtino	Koleno nastavljivo 0°-90°	Koleno nastavljivo 0-90° s čistilno odprtino
Koda	FU0629N	FU0619N	FU0618N	FU0623N	FU06101	FU06102
Ø060*	32,61	24,07	23,56			
Ø080	33,68	24,60	24,07	49,74	36,33	50,76
Ø100	43,37	25,36	25,36	59,32	38,52	52,84
Ø110	47,09	32,07	31,48	63,10	40,69	81,28
Ø115*	48,61	25,36	25,36	67,38	50,76	56,67
Ø120	50,81	25,39	27,53	72,23	45,49	56,67
Ø130	52,98	27,56	29,56	74,88	38,10	57,83
Ø140	55,04	29,59	31,79	81,05	52,84	59,04
Ø150	59,27	29,59	31,79	87,17	40,27	60,25
Ø160	65,66	33,82	35,96	95,17	61,32	122,93
Ø180	82,63	35,99	38,02	105,85	72,82	157,88
Ø200	103,23	42,39	44,41	119,21	81,39	157,48
Ø225*	115,49	50,81	52,84	131,58	145,95	192,37
Ø250	125,61	59,27	61,32	141,25	118,76	188,03
Ø300*	134,26	93,03	93,03	150,83	205,08	225,88
Ø350*	219,79	97,20	97,20	270,58		
Ø400*	257,92	112,05	112,05	298,11		
Ø450*	304,42	122,65	122,65	333,98		
Ø500*	357,29	141,61	141,61	393,20		



\*Po naročilu

FLEKSIBILNE CEVI	Dimniška cev nastavljiva 320-480mm	Cev fleksibilna	Adapter Flex-Flex	Adapter Flex-FU	Adapter FU-Flex
Koda	FU06114	121-F01	FD06	FD07	FD08
Ø060*	41,09				
Ø080	41,74	33,62	40,19	33,76	33,76
Ø100	50,81	41,77	46,56	38,02	38,02
Ø110	52,98	45,91	46,56	40,19	40,19
Ø115*	55,66		50,76	42,33	40,19
Ø120	58,84	50,39	50,76	42,33	40,19
Ø130	61,49	53,80	52,84	44,41	42,33
Ø140	103,63	58,11	54,93	46,56	44,41
Ø150	70,62	62,31	59,15	46,56	46,56
Ø160	116,31	66,28	61,32	48,61	48,61
Ø180	82,94	73,41	65,58	52,84	50,76
Ø200	90,38	82,26	71,86	57,12	54,93
Ø225*	100,02				
Ø250	140,18				
Ø300*	167,46				
Ø350*	215,62				
Ø400*	226,22				
Ø450*	249,47				
Ø500*	266,32				



\*Po naročilu

ZAKLJUČNI ELEMENTI	Zaključek dimnika	Protidežna kapa	Dimniški pokrov	Dimniški pokrov revizijski	Dimniški pokrov s tesnilom za T-kos	Tesnilo silikonsko
Koda	EW0626	FU28	FU43	FU50	ALBI31	ALBI26
Ø060*		14,99				
Ø080	33,17	15,50	38,02	39,23	59,15	3,52
Ø100	34,75	16,06	38,02	43,54	59,15	4,71
Ø110	36,33	17,13				4,71
Ø115*	37,45	17,70	38,02	47,94	59,15	4,71
Ø120	37,96	19,84	40,19	50,11	65,30	5,27
Ø130	38,52	23,05	40,19	56,62	65,30	5,27
Ø140	41,20	24,94	40,19	57,12	65,30	5,27
Ø150	43,79	26,80	42,33	56,62	65,30	5,27
Ø160	47,37	29,45	44,41	56,62	65,30	6,40
Ø180	50,81	32,07	46,56	56,62	65,30	6,40
Ø200	56,70	34,75	48,61	67,52	71,39	6,40
Ø225*	65,18	43,79	50,76			7,10
Ø250	103,23	54,93	52,84	67,52	71,39	7,10
Ø300*	119,21	63,38	57,12	76,12	80,40	8,17
Ø350*		76,12	76,12			8,82
Ø400*		90,92	84,55			9,95
Ø450*		105,71	97,20			11,64
Ø500*		209,34	120,53			13,47



\*Po naročilu

PRITRDILNI ELEMENTI	Montažni distančnik	Rozeta	Objemka	Zidno držalo	Dilatacijski element za vgradnjo - pritrditev v steno	Izolacija 25mm
Koda	FU40	FU72	FU45	VL09	FU42	FU39....-25
Ø060*	8,93	23,90	9,47	40,72	31,17	
Ø080	8,93	23,90	9,47	40,72	29,56	32,30
Ø100	19,05	27,25	10,60	45,68	29,56	32,30
Ø110	23,25	27,25	10,60	46,81	29,56	35,06
Ø115*	23,25	27,25	10,60	46,56	29,56	35,59
Ø120	23,25	27,25	10,60	46,56	31,79	35,59
Ø130	25,36	27,25	10,60	46,56	33,76	36,75
Ø140	25,36	27,25	10,60	46,56	35,96	40,69
Ø150	27,53	31,17	12,65	46,56	35,96	43,43
Ø160	27,53	31,17	12,65	46,56	38,02	47,85
Ø180	27,53	31,17	12,65	52,84	40,19	54,00
Ø200	27,53	35,59	14,85	52,84	40,19	60,62
Ø225*	27,53	35,59	16,99	54,93	46,56	67,30
Ø250	29,56	40,19	21,81	54,93	48,61	76,23
Ø300*	29,56	40,19	25,36	71,86	54,93	83,45
Ø350*	31,79	57,12	27,53	84,55	67,66	128,99
Ø400*	31,79	80,38	31,79	97,20	84,55	162,72
Ø450*	33,76	105,71	38,02	114,11	154,32	190,23
Ø500*	54,93	112,05	54,93	160,69	190,23	

**EWR REDUCIRNI KOSI**

iz Ø / na Ø	80/60									
cena	<b>30,07</b>									
iz Ø / na Ø	100/80									
cena	<b>34,49</b>									
iz Ø / na Ø	110/80	110/100								
cena	<b>35,59</b>	<b>35,59</b>								
iz Ø / na Ø	115/80	115/100	115/110							
cena	<b>38,42</b>	<b>38,02</b>	<b>38,42</b>							
iz Ø / na Ø	120/80	120/100	120/110	120/115						
cena	<b>40,07</b>	<b>38,02</b>	<b>40,07</b>	<b>40,08</b>						
iz Ø / na Ø	130/80	130/100	130/110	130/115	130/120					
cena	<b>42,33</b>	<b>42,33</b>	<b>40,19</b>	<b>42,33</b>	<b>42,33</b>					
iz Ø / na Ø	140/80	140/100	140/110	140/115	140/120	140/130				
cena	<b>44,56</b>	<b>44,56</b>	<b>44,56</b>	<b>44,55</b>	<b>40,19</b>	<b>44,56</b>				
iz Ø / na Ø	150/80	150/100	150/110	150/120	150/130	150/140				
cena	<b>51,12</b>	<b>51,12</b>	<b>51,12</b>	<b>51,12</b>	<b>40,19</b>	<b>51,12</b>				
iz Ø / na Ø	160/80	160/100	160/110	160/120	160/130	160/140	160/150			
cena	<b>52,28</b>	<b>52,28</b>	<b>52,28</b>	<b>52,28</b>	<b>52,28</b>	<b>44,41</b>	<b>52,28</b>			
iz Ø / na Ø	180/80	180/100	180/110	180/120	180/130	180/140	180/150	180/160		
cena	<b>58,39</b>	<b>58,39</b>	<b>58,39</b>	<b>58,39</b>	<b>58,39</b>	<b>58,39</b>	<b>58,39</b>	<b>48,61</b>		
iz Ø / na Ø	200/80	200/110	200/120	200/130	200/140	200/150	200/160	200/180		
cena	<b>64,59</b>	<b>64,59</b>	<b>29,00</b>	<b>64,59</b>	<b>64,59</b>	<b>64,59</b>	<b>64,59</b>	<b>64,59</b>	<b>50,76</b>	
iz Ø / na Ø	250/150	250/160	250/180	250/200	250/220					
cena	<b>98,44</b>	<b>98,44</b>	<b>98,44</b>	<b>98,44</b>	<b>98,44</b>					
iz Ø / na Ø	300/150	300/160	300/180	300/200	300/250	350/300	400/350			
cena	<b>105,18</b>	<b>105,18</b>	<b>105,18</b>	<b>105,18</b>	<b>105,18</b>	<b>162,72</b>	<b>186,06</b>			

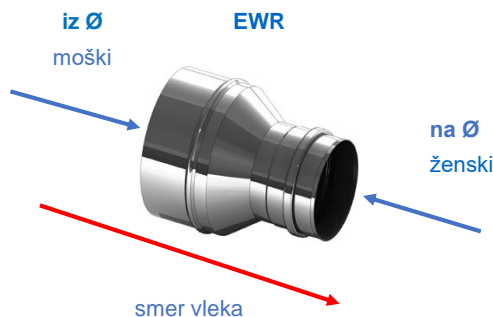

**EWE KONTRAREDCIRNI KOSI**

iz Ø / na Ø	60/80	60/100	60/110	60/130							
cena	<b>30,07</b>	<b>34,49</b>	<b>35,59</b>	<b>42,33</b>							
iz Ø / na Ø	80/100	80/110	80/120	80/130	80/140	80/150	80/160	80/180	80/200		
cena	<b>34,49</b>	<b>35,59</b>	<b>40,07</b>	<b>42,33</b>	<b>44,56</b>	<b>51,12</b>	<b>52,28</b>	<b>58,39</b>	<b>64,59</b>		
iz Ø / na Ø	100/110	100/115	100/120	100/130	100/140	100/150	100/160	100/180	100/200	100/250	
cena	<b>35,59</b>	<b>38,42</b>	<b>38,02</b>	<b>42,33</b>	<b>44,56</b>	<b>51,12</b>	<b>93,03</b>	<b>58,39</b>	<b>64,59</b>	<b>98,44</b>	
iz Ø / na Ø	110/120	110/130	110/140	110/150	110/160	110/180	110/200				
cena	<b>38,02</b>	<b>38,02</b>	<b>44,56</b>	<b>51,12</b>	<b>93,03</b>	<b>58,39</b>	<b>64,59</b>				
iz Ø / na Ø	115/120	115/130	115/140	115/150	115/160						
cena	<b>40,08</b>	<b>40,19</b>	<b>44,55</b>	<b>51,12</b>	<b>52,28</b>						
iz Ø / na Ø	120/130	120/140	120/150	120/160	120/180	120/200	120/250				
cena	<b>42,33</b>	<b>40,19</b>	<b>51,12</b>	<b>52,28</b>	<b>58,39</b>	<b>64,59</b>	<b>98,44</b>				
iz Ø / na Ø	130/140	130/150	130/160	130/180	130/200	130/250					
cena	<b>44,56</b>	<b>40,19</b>	<b>52,28</b>	<b>58,39</b>	<b>64,59</b>	<b>98,44</b>					
iz Ø / na Ø	140/150	140/160	140/180	140/200							
cena	<b>51,12</b>	<b>44,41</b>	<b>58,39</b>	<b>64,59</b>							
iz Ø / na Ø	150/160	150/180	150/200	150/250	150/300	150/350					
cena	<b>52,28</b>	<b>58,39</b>	<b>64,59</b>	<b>98,44</b>	<b>105,18</b>	<b>127,95</b>					
iz Ø / na Ø	160/180	160/200	160/250	160/300							
cena	<b>48,61</b>	<b>64,59</b>	<b>98,44</b>	<b>105,18</b>							
iz Ø / na Ø	180/200	180/250	180/300								
cena	<b>50,76</b>	<b>98,44</b>	<b>105,18</b>								
iz Ø / na Ø	200/250	200/300	200/350	200/400	200/450						
cena	<b>98,44</b>	<b>105,18</b>	<b>127,95</b>	<b>146,35</b>	<b>163,09</b>						
iz Ø / na Ø	250/300	300/450	350/450	500/600							
cena	<b>105,18</b>	<b>108,70</b>	<b>205,08</b>	<b>253,72</b>							

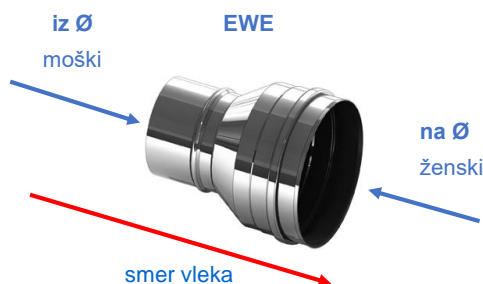

## TROSLOJNI DIMNIKI

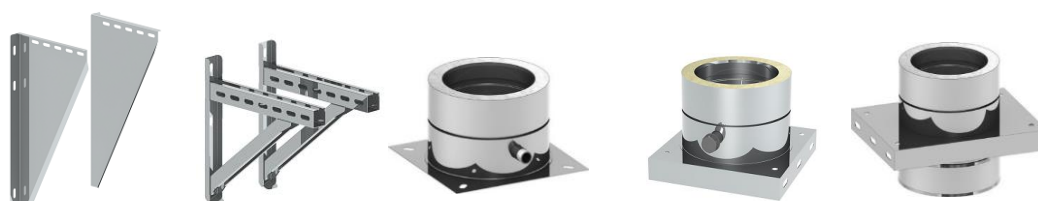
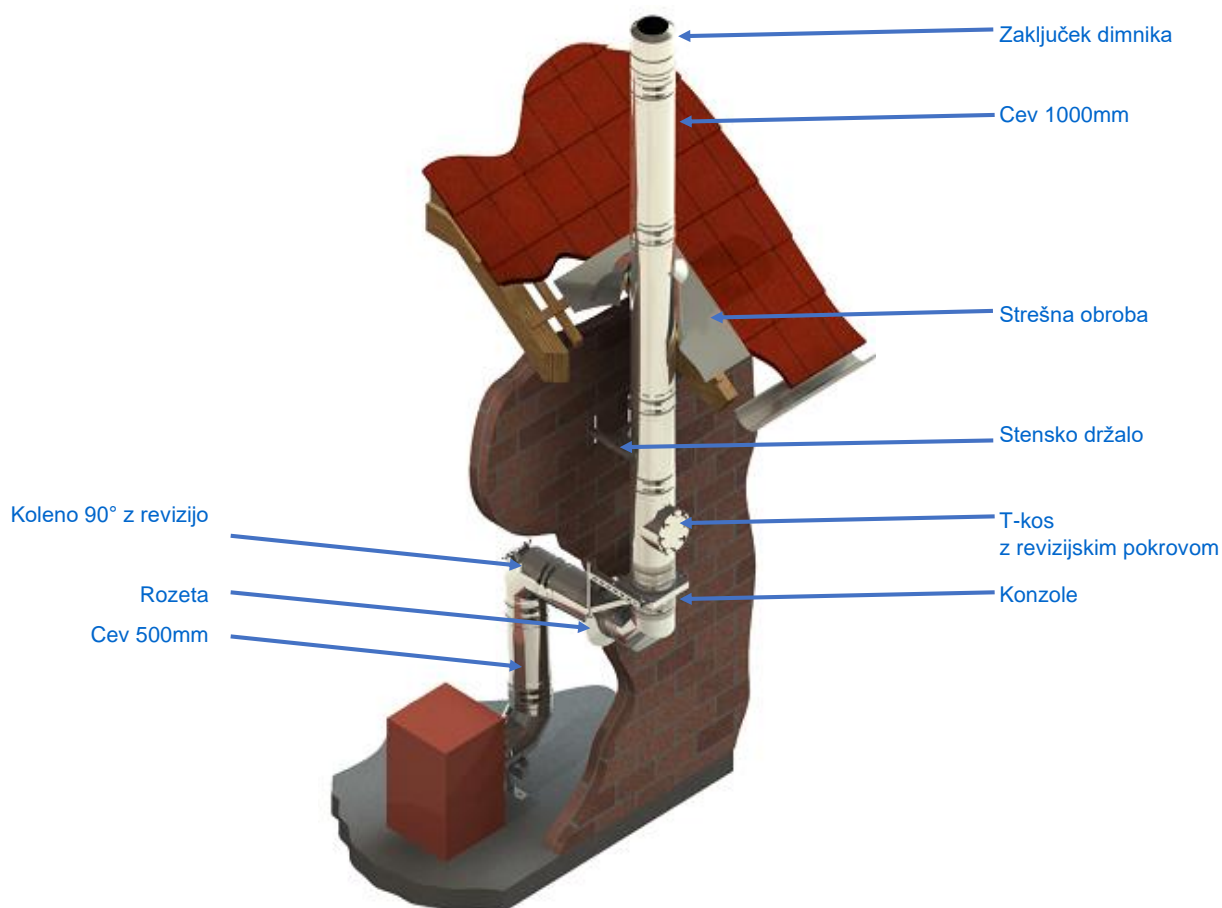

\* Po naročilu

OSNOVE in ODVODI KONDENZA	Konzole 50-150mm	Konzole tip L dol.35cm	Odvod kondenza talni	Odvod kondenza konzolni	Cev s konzolnim priključkom
Koda	DW01	DW391	205-DWETN66	205-DWETN06	205-DWETN07
Ø080 *	86,66	154,78	62,08	75,98	80,66
Ø100 *	86,66		69,02	83,42	88,29
Ø110 *			72,23	88,77	92,55
Ø130	88,77		81,39	101,68	103,74
Ø150	97,20		91,48	113,94	115,01
Ø160	122,65		99,26	124,31	124,93
Ø180	131,13		106,95	134,85	134,85
Ø200	145,95		116,62	142,83	146,60
Ø225 *	241,01		130,54	153,54	158,33
Ø250	283,29		145,45	188,26	190,93
Ø300 *	317,08		182,34	217,65	224,13
Ø350 *	372,03		203,78	229,99	272,83
Ø400 *	505,19		243,38	254,03	303,21
Ø450 *	579,22		285,62	316,68	339,06
Ø500 *	655,29		330,63	363,18	400,10





\* Po naročilu

ČISTILNI ELEMENTI	Dezov veliki z vrati	Cev z revizijsko odprtino	Cev 1000 mm	Cev 500 mm	Cev 250 mm	Rozeta
Koda	205-DWETN10	205-DWETN68	205-DWETN13	205-DWETN14	205-DWETN15	DWECO307
Ø080 *	185,04	323,44	106,95	62,56	36,92	19,30
Ø100 *	220,86	336,13	124,71	76,99	48,13	21,36
Ø110 *	227,26	124,06	129,41	80,66	48,67	21,36
Ø130	244,42	138,49	150,83	90,92	52,98	21,98
Ø150	250,31	173,85	167,91	103,63	59,89	23,05
Ø160	269,34	179,15	181,60	114,11	64,71	24,07
Ø180	288,27	184,56	195,22	122,65	69,50	25,19
Ø200	318,26	209,62	219,31	131,13	75,98	29,48
Ø225 *	325,76	224,13	235,35	154,04	87,73	34,78
Ø250	333,25	251,95	264,26	167,01	96,86	37,48
Ø300 *	388,32	313,98	334,86	191,47	120,31	42,33
Ø350 *	418,76	336,94	371,75	205,42	129,41	48,70
Ø400 *	497,95	371,75	433,83	239,60	151,28	59,44
Ø450 *	546,00	432,68	489,97	277,56	166,33	69,58
Ø500 *	570,71	458,41	542,36	312,43	186,62	82,43



\* Po naročilu

PRIKLJUČNI ELEMENTI	T kos 45°	T kos 90°	Koleno 30°	Koleno 45°	Koleno 90°	Koleno 87° s čistilno odprtino
Koda	205-DWETN12	205-DWETN11	205-DWETN17	205-DWETN18	205-DWETN60	205-DWETN19
Ø080 *	137,44	99,48	66,79	75,98	95,79	386,88
Ø100 *	152,41	120,31	87,17	93,54	112,36	391,08
Ø110 *	160,44	128,90	91,48	101,68	122,99	127,61
Ø130	186,62	165,23	105,71	112,84	140,15	137,44
Ø150	215,56	170,67	118,39	118,39	164,27	166,33
Ø160	241,49	190,93	124,79	124,79	172,45	176,19
Ø180	267,45	211,22	131,13	128,99	180,70	186,17
Ø200	284,05	233,21	135,27	150,18	202,77	204,85
Ø225 *	339,65	266,91	184,03	191,47	240,14	
Ø250	431,61	296,33	143,81	175,49	304,37	301,18
Ø300 *	547,69	381,39	207,14	239,60	371,75	479,94
Ø350 *	752,57	465,31	247,02	265,31	376,57	606,70
Ø400 *	772,36	530,50	306,48	360,50	432,68	718,84
Ø450 *	888,35	621,47	371,16	371,16	503,25	744,09
Ø500 *	1.353,13	909,71	406,47	464,13	695,87	898,44

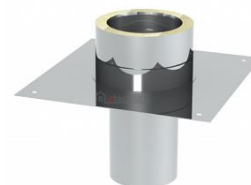

\* Po naročilu

ZAKLJUČNI ELEMENTI	Protidežna kapa	Zaključek s protivetno kapo	Izoliran zaključek dimnika	Zaključni kos EN/DW enoslojni/troslojni
Koda	215-DWECO33	205-DWETN92HS	205-DWETN32	205-DWETN08
Ø080 *	42,75		37,96	84,52
Ø100 *	50,81		44,92	92,55
Ø110 *	54,56		46,02	96,86
Ø130	64,71	120,39	50,81	109,04
Ø150	76,49	134,34	57,77	120,31
Ø160	86,12	144,83	63,38	130,74
Ø180	95,79	150,04	69,02	141,16
Ø200	99,48	167,51	72,23	153,54
Ø225 *	124,71	183,18	79,70	166,33
Ø250	148,66	198,88	87,17	200,57
Ø300 *	175,49	266,94	97,37	235,35
Ø350 *	181,77		134,26	286,16
Ø400 *	200,85		162,58	318,79
Ø450 *	230,44		215,03	356,22
Ø500 *	257,92		250,31	419,91



\* Po naročilu

PREHODI, PRITRDILNI ELEMENTI	Prehodni kos EN/DW enoslojni/troslojni	Prehodni kos DW/EN enoslojni/troslojni	Zidno držalo nastavljivo 50-70mm	Čep z odvodom kondenza za konzole
Koda	205-DWETN37	205-DWETN37A	DWECO690	215-DWECO44
Ø080 *	36,33	52,84	21,16	143,81
Ø100 *	44,41	52,84	23,25	147,98
Ø110 *	46,02			
Ø130	50,30	50,30	25,36	158,55
Ø150	57,12	57,12	29,56	56,19
Ø160	57,12	57,12	31,79	58,36
Ø180	61,32	61,32	31,79	179,74
Ø200	67,66	67,66	33,76	84,69
Ø225 *	79,70			
Ø250	67,66	67,66	40,19	101,74
Ø300 *	74,03	74,03	44,41	230,44
Ø350 *	86,66	86,66	50,76	289,65
Ø400 *	107,80	135,27	52,84	325,59
Ø450 *	128,99	128,99	57,12	382,71
Ø500 *	141,61	158,55		441,84

\*Po naročilu

### PVC CEVI ZA PLINSKE KONDENZACIJSKE PEČI EW-PPS



CEVI ČISTILNI ELEMENTI	Cev 2000 mm	Cev 1000 mm	Cev 500 mm	Cev 250 mm	Cev s čistilno odprtino	Cev z odvodom kondenza in sifonom
Koda	130-PP339	130-PP02	130-PP03	130-PP04	130-PP30	130-PP111
Ø060	23,22	14,36	10,32	7,54	20,90	43,44
Ø080	32,48	18,26	12,01	8,86	26,43	39,16
Ø100 *	50,98	29,76	20,90	15,25	36,96	55,51
Ø110 *	73,54	47,71	27,32	21,70	60,18	89,71
Ø125 *	96,27	60,38	40,88	29,27	93,55	97,85
Ø160 *	127,29	81,77	55,51	45,61	162,99	133,54
Ø200 *	204,07	120,90	93,15	55,51	146,88	184,49
Ø250 *	316,57	221,99	146,88	120,90	316,57	279,16



KOLENA	Koleno 30°	Koleno 45°	Koleno 87°	Koleno 87° s podporo	Koleno s čistilno odprtino	Zaključek dimnika PP
Koda	130-PP18	130-PP19	130-PP22	130-PP06	130-PP23	130-PP837
Ø060	10,32	10,32	11,61	33,57	20,90	76,12
Ø080	12,64	12,64	15,11	54,19	28,84	75,06
Ø100 *	29,01	18,49	23,02	71,62	40,40	
Ø110 *	32,34	32,34	34,55	91,34	80,82	
Ø125 *	49,03	49,03	50,55	133,54	127,52	
Ø160 *	92,00	92,00	92,00	184,49	155,96	
Ø200 *	146,88	146,88	166,49	204,07	184,49	
Ø250 *	221,99	241,49	316,57	429,22	354,22	



ZAKLJUČNI ELEMENTI	Distančnik	Rozeta	Zaključek dimnika z rozeto in cevjo Inox *odprodaja	Razširitveni kos 130-PPE.....				
Koda	130-PP40	FU72	PP342	Ø60	Ø80	Ø100	Ø110	Ø125
Ø060	12,73	23,90	58,76					
Ø080	11,27	23,90	61,48	28,84				
Ø100 *		27,25			36,96			
Ø110 *		27,25			61,30	58,49		
Ø125 *		27,25			148,63	83,03	122,36	
Ø160 *		31,17				94,64		91,34
Ø200 *		35,59						
Ø250 *		40,19						

\*Po naročilu

### PVC CEVI ZA PLINSKE KONDENZACIJSKE PEČI EW-PPS



REDUCIRNI ELEMENTI	Reducirni kos ekscentričen					Reducirni kos					
	130-PPE.....EX					130-PPR.....					
Koda	Ø60	Ø80	Ø100	Ø110	Ø160	Ø80	Ø100	Ø110	Ø125	Ø160	Ø200
Ø060						31,19					
Ø080	39,31						31,19	31,19			
Ø100 *		47,36						36,96	76,12		
Ø110 *		80,22	80,22						91,34		
Ø125 *			83,03	57,23						91,34	
Ø160 *			166,49								184,49
Ø200 *					109,43						
Ø250 *											

### FLEKSIBILNE PVC CEVI ZA PLINSKE KONDENZACIJSKE PEČI EW-PP-FLEX



Naziv	Cev fleksibilna	Cev z revizijsko odprtino	Adapter za flex cev	Montažni set 1	Montažni set 2
Koda	PPFLEX02	PPFLEX30	PPFLEX07	PPFLEX09	PPFLEX804
Ø060	23,14	85,64	46,24		40,88
Ø080	26,12	111,99	69,24	19,98	43,44
Ø100 *	45,64	136,13	92,23		49,03
Ø110 *		143,44	100,66		63,91
Ø125 *	88,10	277,41	156,80		184,49
Ø160 *	121,93	315,03	182,86		221,99

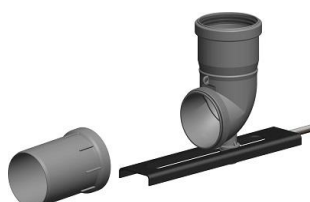

Naziv	Distančnik - 4 kosi	Koleno z snemljivim priključkom in podporo
Koda	PPFLEX41	130-PP1234
Ø060		69,93
Ø080		76,12
Ø100	11,61	
Ø110	11,61	

\*Po naročilu

### KOAKSIALNI DIMNIKI ZA PLINSKE KONDENZACIJSKE PEČI TWIN-PL



Naziv	Cev 1000 mm	Cev 500 mm	Cev 250 mm	Cev s čistilno odprtino	Cev z merilno odprtino
Koda	<b>TWPL13</b>	<b>TWPL14</b>	<b>TWPL15</b>	<b>TWPL10</b>	<b>TWPL51</b>
<b>ø060/100</b>	<b>47,36</b>	<b>30,07</b>	<b>23,65</b>	<b>90,31</b>	<b>68,84</b>
<b>ø080/125</b>	<b>49,46</b>	<b>32,34</b>	<b>25,80</b>	<b>94,64</b>	<b>71,02</b>
<b>ø100/150 *</b>	<b>58,11</b>	<b>34,35</b>	<b>34,35</b>	<b>118,32</b>	<b>92,49</b>
<b>ø110/160 *</b>	<b>71,02</b>	<b>43,06</b>	<b>34,35</b>	<b>141,89</b>	<b>111,84</b>



Naziv	Koleno 30°	Koleno 45°	Koleno 87°	Koleno 87° s čistilno odprtino	T kos 87° z revizijo in priključkom na kotel
Koda	<b>TWPL17</b>	<b>TWPL18</b>	<b>TWPL64</b>	<b>TWPL67</b>	<b>TWPL308</b>
<b>ø060/100</b>	<b>45,18</b>	<b>32,34</b>	<b>66,72</b>	<b>133,40</b>	<b>98,88</b>
<b>ø080/125</b>	<b>49,46</b>	<b>45,18</b>	<b>71,02</b>	<b>141,89</b>	<b>101,12</b>
<b>ø100/150 *</b>	<b>71,02</b>	<b>58,11</b>	<b>77,44</b>	<b>157,00</b>	<b>129,04</b>
<b>ø110/160 *</b>	<b>51,63</b>	<b>64,48</b>	<b>83,86</b>	<b>172,02</b>	<b>150,55</b>



Naziv	Rozeta	Zaključek dimnika črn	Zunanje tesnilo	Strešna obroba 0-48°
Koda	<b>TWL31</b>	<b>TWPL1944</b>	<b>TW26</b>	<b>TWPL354</b>
<b>ø060/100</b>	<b>32,34</b>	<b>152,78</b>		<b>208,63</b>
<b>ø080/125</b>	<b>34,35</b>	<b>159,12</b>	<b>23,65</b>	<b>208,63</b>
<b>ø100/150 *</b>	<b>34,35</b>			
<b>ø110/160 *</b>	<b>36,58</b>			

## ČRNI DIMNIKI ZA KAMINE IN KAMINSKE PEČI FERRO



CEVI	Cev 1000mm		Cev 500mm		Cev 250mm		Cev z revizijo in loputo 500mm		Cev z loputo 500mm		Dimniški radiator (po naročilu)		Zidni vložek 100mm	
	FERRO	1401 črna	3401 siva	1403 črna	3403 siva	1405 črna	3405 siva	1451 črna	3451 siva	1418 črna	3418 siva	1102 črn	1413 črna	3413 siva
Ø120	56,31	56,31	29,44	29,44	17,24	17,24	68,59	68,59	49,14	49,14			18,59	
Ø130	58,77	58,77	31,93	31,93	19,65	19,65	68,59	68,59	51,44	51,44				
Ø150	68,59	68,59	39,24	39,24	22,14	22,14	71,00	71,00	53,93	53,93	71,00		18,59	18,59
Ø160	76,92	76,92	41,75	41,75	24,49	24,49	80,91	80,91	58,77	58,77			26,51	
Ø180	84,00	84,00	46,51	46,51	26,98	26,98	83,56	83,56	68,59	68,59			29,14	31,74
Ø200	92,67	92,67	55,37	55,37	31,93	31,93	99,61	99,61	75,95	75,95			31,74	



KOLENA	Koleno 45°		Koleno 90°		Koleno 90° z vratci čistilno		Koleno 0- 90° gibljivo		Koleno 0-90° gibljivo z revizijo		Rozeta 55mm		Rozeta 85mm	
	FERRO	1410 črna	3410 siva	1454 črna	3454 siva	1407 črna	3407 siva	1101 črna	3101 siva	1431 črna	3431 siva	1422 črna	3422 siva	1423 črna
Ø120	53,24	53,24	61,84	61,84	55,73	55,73	60,04		61,84	61,84	9,32	9,32	16,30	16,30
Ø130	53,24	53,24	66,99	66,99	60,38	60,38			66,99	66,99	9,32	9,32	18,59	18,59
Ø150	57,97	57,97	77,31	77,31	69,51	69,51	71,55	75,12	77,31	77,31	11,57	11,57	25,54	25,54
Ø160	64,97	64,97	87,57	87,57	78,86	78,86	74,13		87,57	87,57	14,00	14,00	30,13	30,13
Ø180	74,18	74,18	95,32	95,32	85,78	85,78	82,12	94,49	95,32	95,32	14,00	14,00	30,13	30,13
Ø200	85,78	85,78	113,25	113,25	102,05	102,05	92,72		113,25	113,25	16,30	16,30	34,75	34,75

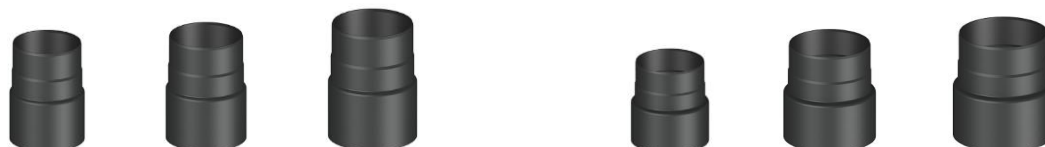

RAZŠIRITVENI KOSI	DN120		DN130	DN150	DN160	DN180	REDUCIRNI KOSI	DN130	DN150	DN160	DN180	DN200	
	FERRO-	E1110 črna	E1120 črna	E3120 siva	E1130 črna	E1150 črna		E1160 črna	E1180 črna	FERRO-	R1130 črna	R1150 črna	R1160 črna
Ø120	33,59							Ø120	39,46	45,16			
Ø130		39,46						Ø130		45,16		40,87	
Ø150	58,27	42,11	68,81	42,11				Ø150		46,29	60,26	71,00	
Ø160		42,11		44,11				Ø160			60,26	71,00	
Ø180		68,81		71,55	42,25	42,25		Ø180				71,89	
Ø200		71,55		74,13	43,75	43,75	56,67	Ø200					

### ČRNI DIMNIKI ZA PELETNE KAMINE EWEC.



CEVI	Cev za peletne kamine 1000mm	Cev za peletne kamine 500mm	Cev za peletne kamine 250mm	Cev za peletne kamine z revizijo 500mm	Objemka	Rozeta
Koda	<b>6C15AL.013</b>	<b>6C15AL.014</b>	<b>6C15AL.015</b>	<b>6C15AL.725</b>	<b>4C1500.045</b>	<b>15-ZUWA676</b>
<b>ø80</b>	<b>60,87</b>	<b>39,88</b>	<b>32,38</b>	<b>72,29</b>	<b>19,05</b>	<b>26,63</b>
<b>ø100</b>	<b>64,68</b>	<b>47,51</b>	<b>38,02</b>	<b>79,92</b>	<b>19,05</b>	<b>26,63</b>



PRIKLJUČNI KOSI	Koleno 90°	Koleno 90° z revizijo	Koleno 45°	T-kos za peletne kamine s kondenzno posodo
Koda	<b>6C15AL.060</b>	<b>6C15AL.019</b>	<b>6C15AL.018</b>	<b>6C15AL.557</b>
<b>ø80</b>	<b>51,35</b>	<b>83,70</b>	<b>36,19</b>	<b>91,34</b>
<b>ø100</b>	<b>55,12</b>	<b>87,59</b>	<b>36,19</b>	<b>95,17</b>







## ČISTILNI PRIBOR ZA PEČI, KAMINE IN DIMNIKE

<b>7005</b>	<b>7000</b>	<b>7001</b>	<b>7002</b>	<b>7003</b>	<b>7004</b>	<b>Vedro10 Vedro12 Vedro15</b>	<b>4779022361098</b>
Komplet za čiščenje	Lopata	Grebljica	Krtača	Kljuka	Nosilec pribora za čiščenje	Vedro za pepel 10/12/15 litrov	Negorljive rokavice par
<b>14,64</b>	<b>4,27</b>	<b>3,05</b>	<b>6,10</b>	<b>3,05</b>	<b>2,44</b>	<b>7,32 8,54 9,76</b>	<b>35,38</b>

<b>4779022360596</b>	<b>4779022361012</b>	<b>4779022360558</b>	<b>4779022360619</b>	<b>4779022360565</b>
Rotacijska fleksibilna cev za čiščenje Tornado (cev 6m)	Palica za čiščenje (za univerzalno ščetko) 6 x 1m	Univerzalna ščetka ø400mm za čiščenje dimnika	Dimne kapsule za kontrolo vleka	Kaminski termometer magnetni
<b>231,80</b>	<b>38,92</b>	<b>18,18</b>	<b>12,20</b>	<b>15,74</b>

<b>4779022360237</b>	<b>4779022361326</b>	<b>4779022360176</b>	<b>4779022360220</b>	<b>4779022360572</b>	<b>4779022360183</b>
Odstranjevalec saj briket 1,1kg	Odstranjevalec saj v vrečkah 5 x 18g za kamine 7-14kW	Odstranjevalec saj v vrečkah 0,5kg (10 x 50g)	Briketi za vžig 32 kosov	Koncentrirani odstranjevalec saj v prahu 0,5kg	Koncentrirani odstranjevalec saj v prahu 1kg
<b>13,66</b>	<b>6,66</b>	<b>11,96</b>	<b>1,88</b>	<b>7,08</b>	<b>15,25</b>

<b>4779022360169</b>	<b>4779022360626</b>	<b>4779022360411</b>	<b>4779022361739</b>	<b>4779022360275</b>	<b>4779022360114</b>	<b>4779022360145</b>	<b>4779022360138</b>
Čistilna pena 500ml za kaminsko steklo	Čistilna pena Eco 500ml za kaminsko steklo	Goba za suho in mokro čiščenje kaminskega stekla	Barva v spreju do 800°C 400ml bela 990	Barva v spreju do 800°C 400ml siva 970	Barva v spreju do 800°C 400ml antracit 930	Barva v spreju do 800°C 400ml dark antracit 937	Barva v spreju do 800°C 400ml črna 910
<b>10,25</b>	<b>13,66</b>	<b>5,98</b>	<b>13,42</b>	<b>13,42</b>	<b>13,42</b>	<b>13,42</b>	<b>13,42</b>

<b>4779022360480</b>	<b>4779022360459</b>	<b>4779022360466</b>	<b>4779022360473</b>	<b>4779022360695</b>	<b>4779022360510</b>	<b>477922360640</b>	<b>4779022360930</b>
Samolepilna tesnilna vrstica 10 x 2 mm	Tesnilna vrstica 6 mm do 850°C	Tesnilna vrstica 8 mm do 850°C	Tesnilna vrstica 10 mm do 850°C	Tesnilna vrstica 12 mm do 850°C	Lepilo za tesnilno vrstico do 1200°C 17 ml	Usnjena košara za drva 35 x 35 x 50cm	Nylon košara za drva 46 x 25 x 24cm
<b>20,98</b>	<b>10,49</b>	<b>13,91</b>	<b>17,32</b>	<b>22,94</b>	<b>12,20</b>	<b>195,08</b>	<b>17,08</b>

## ELEKTRIČNI KOTEL stenski

Koda	Naziv	Cena
<b>ECO-08MRT</b>	Električni kotel 08MRT stenski	<b>839,36</b>
<b>ECO-12MRT</b>	Električni kotel 12MRT stenski	<b>844,24</b>



**NOVO**

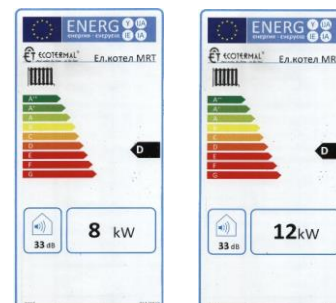

Pretočni električni kotel ECOTERMAL je sodoben ekološki vir toplote, namenjen za etažno in centralno ogrevanje manjših in srednje velikih objektov. Glavne prednosti ogrevanja z električno energijo so predvsem **stroškovna učinkovitost, visok izkoristek, prijaznost do okolja in zanesljivost.**

Električni kotel se lahko uporablja v vsakem sistemu centralnega ali etažnega (lokalnega) ogrevanja v direktnem, akumulacijskem ali hibridnem sistemu.

Možno ga je vgraditi tudi v obstoječe ogrevalne sisteme vzporedno s kotlom na trda goriva ali toplotno črpalko. Pri odprtem sistemu deluje do temperature 95°C max., pri zaprtem sistem do 110°C pri tlaku 1,8 bar v samostojnem ogrevalnem krogu.

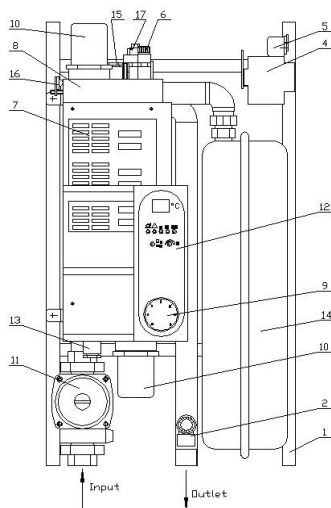

### SESTAVA ELEKTRIČNEGA KOTLA

1. Okvir
2. Varnostni ventil 2,5 bar
4. Avtomatske varovalke
5. Zasilni (blokirni) termostat
6. Odzračevalni lonček
7. Regulacija
8. Izmenjevalec
9. Manometer
10. Grelniki
11. Obtočna črpalka
12. Nadzorna plošča
13. Ventil za manometer
14. Raztezna posoda
15. Prostor za termostat
16. Termostat – bimetalni
17. Tlačno stikalo

### TEHNIČNE LASTNOSTI

Model		ECO-08MRT	ECO-12MRT
Moč	kW	8	12
<b>Dimenzije</b>			
Višina	mm	700	700
Širina	mm	385	385
Globina	mm	260	260
Teža	kg	29,0	29,0
<b>Tehnične značilnosti</b>			
Stopnje modulacije		3	3
Volumen izmenjevalca kotlov	dm <sup>3</sup>	8,9	8,9
Napajanje	V	240 / 400	240 / 400
<b>Tehnični podatki</b>			
Grelec	(A)	11,11	16,67
Prečni presek napajalnih kablov	[mm <sup>2</sup> ]	5 x 2,5	( 3 x 4 + 2,5 ) + 1 x 4
Varovalka	(A)	16	25
Največji delovni tlak	Bar	2,50	2,50
Testni tlak	Bar	4,00	4,00
Regulacija temp. toplotnega medija	°C	30 - 90	30 - 90
Nadzor sobne temperature	°C	5 - 30	5 - 30
Dimenzije priključnih cevi		1"	1"
Indeks učinkovitosti	%	99,30	99,30
<b>Oprema kotlov</b>			
Raztezna posoda		da	da
Obtočna črpalka		da	da
Varnostni ventil		da	da
Varnostno stikalo		da	da
Termostat		da	da
Odzračevalni lonček		da	da
Montažni nosilci		da	da

## TOPLOTNA ČRPALKA monoblock z inverterskim modulom PRIMA 6-16GT

Koda	EAN	Naziv	Cena
<b>09-400600</b>		PRIMA 6GT - monoblock toplotna črpalka inverter	<b>4.867,80</b>
<b>09-400800</b>		PRIMA 8GT - monoblock toplotna črpalka inverter	<b>5.477,80</b>
<b>09-401000</b>		PRIMA 10GT - monoblock toplotna črpalka inverter	<b>6.051,20</b>
<b>09-401210</b>		PRIMA 3F 12GT - monoblock toplotna črpalka inverter	<b>7.015,00</b>
<b>09-401610</b>		PRIMA 3F 16GT - monoblock toplotna črpalka inverter	<b>7.535,21</b>

3 funkcije v 1 napravi -  
ogrevanje, hlajenje  
in sanitarna voda

Najvišji razred energetske  
učinkovitosti

Spletni nadzor prek  
aplikacije - priloženo

Tiho delovanje

Ekološko hladilno sredstvo

Garancija: 5 let



Tehnične lastnosti			PRIMA 6GT	PRIMA 8GT	PRIMA 10GT	PRIMA 3F 12GT	PRIMA 3F 16GT
Grelna moč		enota					
Priključna moč	ogrevalni način (A7W35)	kW	6,35	8,40	10,00	12,10	12,10
Koeficient učinkovitosti - COP			1,28	1,63	2,02	2,44	3,53
Grelna moč	ogrevalni način (A7W35)	kW	6,00	7,50	9,50	11,90	16,00
Priključna moč		kW	2,03	2,36	3,06	3,90	5,61
Koeficient učinkovitosti - COP			2,95	3,18	3,10	3,05	2,85
Hladilna moč	hladilni način (A7W35)	kW	7,00	7,45	8,20	11,50	14,00
Priključna moč		kW	2,33	2,22	2,52	4,18	5,60
EER			3,00	3,35	3,25	2,75	2,50
ErP razred energetske učinkovitosti	W35				A+++		
	W55				A++		
Razpon regulacije grelne moči (min/max) A7W35		kW	2,73 / 7,41	3,36 / 9,11	3,81 / 10,03	5,58 / 14,60	6,43 / 16,80
Moč dodatnega električnega grelnika		kW	3	3	3	9	9
Zvočna moč		dB	58	59	60	65	68
Zvočni tlak na razdalji 3m		dB	40	41	42	45	48
Kompresor					dvojni rotacijski		
Ventilator					DC		
Toplotni izmenjevalnik (uparjalnik)					lamelni		
Hladilno sredstvo			R32 1,4kg	R32 1,4kg	R32 1,4kg	R32 1,75kg	R32 1,75kg
Dimenzije (v x š x g)		mm	792x1295x429	945x1385x526	945x1385x526	945x1385x526	945x1385x526
Dimenzije paketa (v x š x g)		mm	945x1375x475	1120x1465x560	1120x1465x560	1120x1465x560	1120x1465x560
Neto/bruto teža		kg	103 / 126	126 / 153	126 / 153	165 / 193	165 / 193
Območje delovanja (zunanja temperatura)	hlajenje	°C			-5 ~ 43		
	ogrevanje	°C			-25 ~ 35		
	sanitarna voda	°C			-25 ~ 43		
Toplotni izmenjevalnik (uparjalnik)					tip plošče		
Priključki			1	5/4	5/4	5/4	5/4
Temperaturno območje vode	hlajenje	°C			5 ~ 30		
	ogrevanje	°C			12 ~ 65		
	sanitarna voda	°C			10 ~ 60		
Napetost in frekvenca		V / Hz	220-240 / 50	220-240 / 50	220-240 / 50	280-415 / 50	280-415 / 50

Skladno s standardom EN 14511 A - temperatura zraka;  
W - temperaturno območje ogrevane vode

Skladno s standardom EN 12102

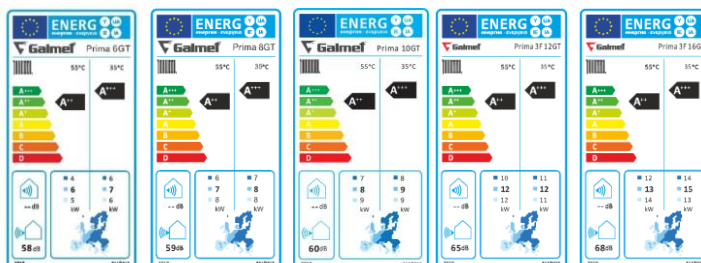

## TOPLOTNA ČRPALKA split inverter PRIMA S 6-16GT

Koda	EAN	Naziv	Cena
09-410600		PRIMA S 6GT - toplotna črpalka split inverter	5.439,98
09-410800		PRIMA S 8GT - toplotna črpalka split inverter	6.140,26
09-411000		PRIMA S 10GT - toplotna črpalka split inverter	6.140,26
09-411210		PRIMA S 3F 12GT - toplotna črpalka split inverter	7.340,74
09-411610		PRIMA S 3F 16GT - toplotna črpalka split inverter	7.840,94

3 funkcije v 1 napravi - ogrevanje, hlajenje in sanitarna voda

Najvišji razred energetske učinkovitosti

Spletni nadzor prek aplikacije - priloženo

Tiho delovanje

Ekološko hladilno sredstvo

Garancija: 5 let



Tehnične lastnosti		enota	PRIMA S 6GT	PRIMA S 8GT	PRIMA S 10GT	PRIMA S 3F 12GT	PRIMA S 3F 16GT
Zunanja enota			ODU Prima S 6GT	ODU Prima S 8GT	ODU Prima S 10GT	ODU Prima S 12GT	ODU Prima S 16GT
Notranja enota			IDU Prima S 6GT	IDU Prima S 8GT	IDU Prima S 10GT	IDU Prima S 12GT	IDU Prima S 16GT
Grelna moč	ogrevalni način	kW	6,20	8,30	10,00	12,10	16,00
Priključna moč	(A7W35)	kW	1,24	1,60	2,00	2,44	3,56
Koeficient učinkovitosti - COP			5,00	5,20	5,00	4,95	4,50
Grelna moč	ogrevalni način	kW	6,00	7,50	9,50	12,00	16,00
Priključna moč	(A7W35)	kW	2,00	2,36	3,06	3,87	5,52
Koeficient učinkovitosti - COP			3,00	3,18	3,10	3,10	2,90
Hladilna moč	hladilni način	kW	7,00	7,40	8,20	11,60	14,00
Priključna moč	(A7W35)	kW	2,33	2,19	2,48	4,22	5,71
EER			3,00	3,38	3,30	2,75	2,45
ErP razred energetske učinkovitosti	W35				A+++		
	W55				A++		
Nazivni pretok vode		m³/h	1,07	1,43	1,72	2,08	2,75
Kompresor			dvojni rotacijski				
Ventilator			DC				
Toplotni izmenjevalnik (uparjalnik)			lamelni				
Hladilno sredstvo			R32 1,5kg	R32 1,65kg	R32 1,65kg	R32 1,84kg	R32 1,84kg
	vrsta priključka	mm	navojni priključek				
	tekočina (ø)	mm	6,35	9,52	9,52	9,52	9,52
	plin (ø)	m	15,9				
	min. dolžina	m	2				
	max. dolžina	m	30				
Dovoljena razlika v viš. namestitve enot		m	20				
Zvočna moč (nivo hrupa) zunanje enote		dB	58	59	60	64	68
Zvočni tlak zunanje enote		dB	38	39	40	44	48
Zvočna moč (nivo hrupa) notranje enote		dB	38	42	42	43	43
Dimenzije zunanje enote (v x š x g)		mm	712x1008x426	865x1118x523	865x1118x523	865x1118x523	865x1118x523
Dimenzije notranje enote (v x š x g)		mm	790x420x270	790x420x270	790x420x270	790x420x270	790x420x270
Dimenzije paketa zunanje enote (v x š x g)		mm	800x1065x485	890x1180x560	890x1180x560	890x1180x560	890x1180x560
Dimenzije paketa notranje enote (v x š x g)		mm	1050x525x360	1050x525x360	1050x525x360	1050x525x360	1050x525x360
Neto/bruto teža zunanje enote		kg	60 / 65,5	78,5 / 92	78,5 / 92	116 / 129,5	116 / 129,5
Neto/bruto teža notranje enote		kg	43 / 49	43 / 49	43 / 49	45 / 51	45 / 51
Razpon regulacije grelne moči (min/max) A7W35		kW	2,7 / 7,4	3,4 / 9,1	3,8 / 10,3	5,6 / 14,6	6,4 / 16,8
Moč dodatnega električnega grelca		kW	3	3	3	9	9
Priključki notranje enote		"	1	1	1	1	1
	hlajenje	°C	-5 ~ 43				
	ogrevanje	°C	-25 ~ 35				
	sanitarna voda	°C	-25 ~ 43				
Toplotni izmenjevalnik (uparjalnik)			lamelni				
	hlajenje	°C	5 ~ 25				
	ogrevanje	°C	25 ~ 65				
	sanitarna voda	°C	30 ~ 60				
Napajanje		V / Hz	220-240 / 50	220-240 / 50	220-240 / 50	380-415 / 50	380-415 / 50
	notranja enota	V / Hz	220-240 / 50	220-240 / 50	220-240 / 50	380-415 / 50	380-415 / 50

Skladno s standardom EN 14511 A - temperatura zraka;  
W - temperaturno območje ogrevane vode

Skladno s standardom EN 12102

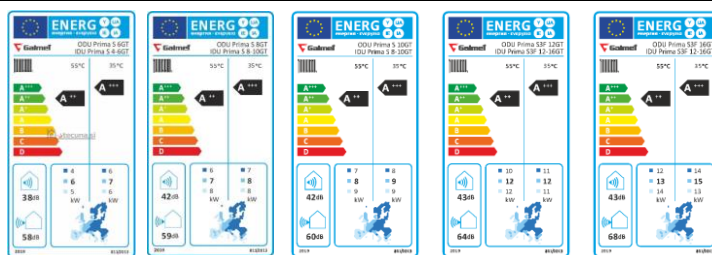

## TOPLOTNA ČRPALKA ZA OGREVANJE SPLIT DC INVERTER

Koda	EAN	Naziv		Cena
<b>MIDEA6SPLIT</b>		Midea S 6kW - toplotna črpalka, split inverter	Zunanja + notranja enota	<b>5.439,98</b>
<b>MIDEA8SPLIT</b>		Midea S 8kW - toplotna črpalka, split inverter	Zunanja + notranja enota	<b>6.140,26</b>
<b>MIDEA3F12SPLIT</b>		Midea S 3F 12kW - toplotna črpalka, split inverter	Zunanja + notranja enota	<b>7.340,74</b>
<b>MIDEA3F14SPLIT</b>		Midea S 3F 14kW - toplotna črpalka, split inverter	Zunanja + notranja enota	<b>7.540,82</b>
<b>MIDEA3F16SPLIT</b>		Midea S 3F 16kW - toplotna črpalka, split inverter	Zunanja + notranja enota	<b>7.840,94</b>
<b>MIDEA3F30MONO</b>		Midea 30kW - toplotna črpalka, monoblock inverter	Zunanja + notranja enota	<b>10.790,90</b>

### GARANCIJA:

2eti + 3 leta po servisni shemi proizvajalca

### MIDEA

toplotni izmenjevalec

### MITSUBISHI

kompresor twin - rotary

### ELEKTRONSKA

obtočna črpalka



SPLIT INVERTER ZUNANJA ENOTA



NOTRANJA ENOTA



MONOBLOCK DC INVERTER 30kW

Tehnične lastnosti		SPLIT DC INVERTER					MONO DC INVERTER
MODEL	enota	MHA-V 6W/HB-A60	MHA-V 8W/HB-A100	MHA-V 12W/HB-A160	MHA-V 14W/HB-A160	MHA-V 16W/HB-A160	MHC-V 30W D2R8
Električni priključek	V/Hz/Ph	220/50/1	220/50/1	380/50/3	380/50/3	380/50/3	380/50/3
Električni tok	A	16	20	12	12	12	12
Tip hladiva		R 32	R 32	R 32	R 32	R 32	R 32
Grelna moč	kW	6	8	12	14	16	30
COP + 2 - 35 - 7 - 55°C energetski certifikat	A+++/A++	5,01	5,21	4,95	4,71	4,51	3,99
Temperatura sistemske vode max	°C	65	65	65	65	65	60
Temperatura san. vode min - max - nastavljivo	°C	30 - 60	30 - 60	30 - 60	30 - 60	30 - 60	30 - 60
Minimalna zunanja temperatura	°C	-25	-25	-25	-25	-25	-25
WI FI krmiljenje	vgrajeno	155,73	155,73	155,73	155,73	155,73	155,73
<b>Notranja enota</b>							
Tipalo za sanitarni vodo		DA	DA	DA	DA	DA	DA
Dimenzije notranje enote Š x V x G	mm	42 x 79 x 27	42 x 79 x 27	42 x 79 x 27	42 x 79 x 27	42 x 79 x 27	
Teža notranje enote	kg	37	37	39	39	39	
<b>Zunanja enota</b>							
Število kompresorjev		1	1	1	1	1	1
Št. ventilatorjev		1	1	1	1	1	2
Dimenzije zunanje enote Š x V x G	mm	100 x 72 x 43	112 x 86 x 53	112 x 86 x 53	112 x 86 x 53	112 x 86 x 53	113 x 156 x 54
Teža zunanje enote	kg	58	77	112	112	114	178

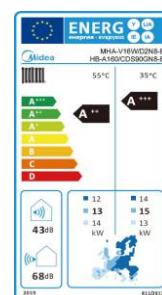
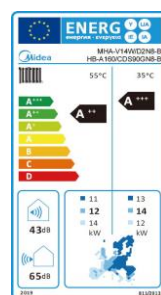
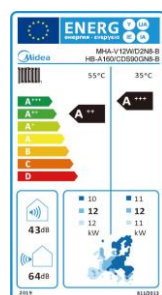
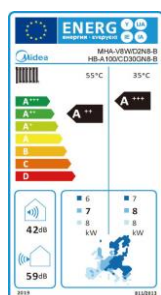
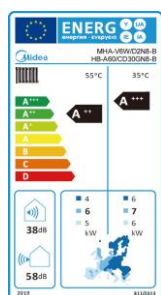
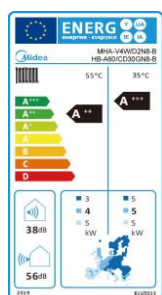

## TOPLOTNA ČRPALKA ZA OGREVANJE SPLIT DC INVERTER z bojlerjem

Koda	EAN	Naziv	Cena
<b>MIDEA6W190SPLIT</b>		Midea S 6kW - toplotna črpalka, split inverter z integriranim bojlerjem 190L	<b>7.890,96</b>
<b>MIDEA8W190SPLIT</b>		Midea S 8kW - toplotna črpalka, split inverter z integriranim bojlerjem 190L	<b>8.091,04</b>
<b>MIDEA3F12W240SPLIT</b>		Midea S 3F 12kW - toplotna črpalka, split inverter z integriranim bojlerjem 240L	<b>9.190,26</b>
<b>MIDEA3F14W240SPLIT</b>		Midea S 3F 14kW - toplotna črpalka, split inverter z integriranim bojlerjem 240L	<b>6.750,26</b>
<b>MIDEA3F16W240SPLIT</b>		Midea S 3F 16kW - toplotna črpalka, split inverter z integriranim bojlerjem 240L	<b>9.490,38</b>

**GARANCIJA:**  
2 leti + 3 leta kompresor  
po servisni shemi proizvajalca

**MIDEA**  
toplotni izmenjevalec

**MITSUBISHI**  
kompresor twin - rotary

**ELEKTRONSKA**  
obtočna črpalka



Tehnične lastnosti		SPLIT DC INVERTER					
MODEL	enota	MHA-V4W/190	MHA-V6W/190	MHA-V8W/190	MHA-V12W/240	MHA-V14W/240	MHA-V16W/240
Električni priključek	V/Hz/Ph	220/50/1	220/50/1	220/50/1	380/50/3	380/50/3	380/50/3
Električni tok	A	16	16	20	16	16	16
Tip hladilne		R 32	R 32	R 32	R 32	R 32	R 32
Grelna moč	kW	6	6	8	12	14	16
COP + 2 - 35 - 7 - 55°C energetski certifikat	A+++/A++	5,01	5,01	5,21	4,95	4,71	4,51
Temperatura sistemske vode do	°C	65	65	65	65	65	65
Temperatura san. vode min - max - nastavljivo	°C	30 - 60	30 - 60	30 - 60	30 - 60	30 - 60	30 - 60
Minimalna zunanja temperatura	°C	-25	-25	-25	-25	-25	-25
Notranja enota z bojlerjem 190 ali 240 l		190 l	190 l	190 l	240 l	240 l	240 l
Možnost cirkulacije		DA	DA	DA	DA	DA	DA
Dimenzije notranje enote Š x V x G	cm	60 x 60 x 168	0	0	60 x 60 x 194	0	0
Teža notranje enote	kg	135	135	135	165	165	165
<b>Zunanja enota</b>							
Število kompresorjev		1	1	1	1	1	1
Št. ventilatorjev		1	1	1	1	1	1
Dimenzije zunanje enote Š x V x G	cm	100 x 72 x 43	100 x 72 x 43	112 x 86 x 53	112 x 86 x 53	112 x 86 x 53	112 x 86 x 53
Teža zunanje enote	kg	58	58	77	112	112	114

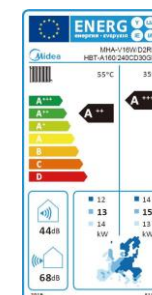
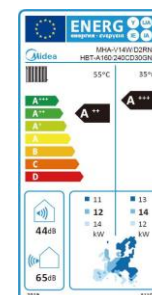
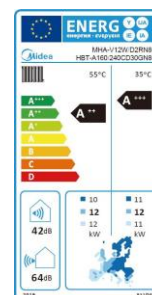
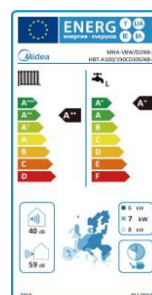
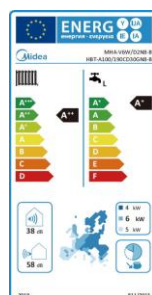
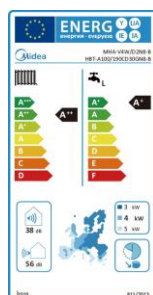

## TOPLOTNA ČRPALKA ZRAK / VODA HOTJET ONE 2(i) - inverter

Koda	Naziv	Moč (kW)	Cena
HJ07ZETXe	Hotjet 7 ONE2(i)	A7/W35 za 60Hz : 6,00 / 4,8	8.552,20
EKOJ10ZETXe	Hotjet 10 ONE2(i)	A7/W35 za 60Hz : 7,98 / 4,72	9.052,40
EKOJ20ZETXe	Hotjet 20 ONE2(i)	A7/W35 za 60Hz : 12,00 / 4,9	10.321,20



Ogrevanje (do 60°C), hlajenje (hladilno sredstvo R454B (GWP 466) podobni parametri kot R410A), inverter Copeland Scroll YHB, el. omarica s Siemens regulacijo RVS, sobna / kontrolna enota QAA75, EC ventilator, Danfoss sofstarter

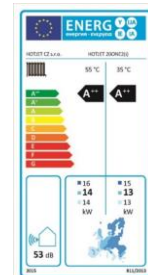
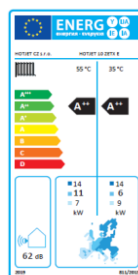

Tehnični podatki		HJ07 ZETXe	EKOJ10 ZETXe	EKOJ20 ZETXe
<b>Podatki o učinkovitosti</b>	enota	Moč ogrevanja [kW] / Poraba energije [kW] / Faktor ogrevanja [COP]		
Nazivna moč (min. / max.) kW	6,0	6,0 (0,9-8,0)	8,0 (2,0-10,7)	10,0 (3,0-14,5)
Nazivna moč / COP za A7/W35 1) - za 60Hz	kW / -	6,00 / 4,8	7,98 / 4,72	12,00 / 4,9
Nazivna moč / COP za A2/W35 1) - za 60Hz	kW / -	4,10 / 3,40	5,65 / 3,60	8,60 / 3,60
Nazivna moč / COP za A-7/W35 1) - za 60Hz	kW / -	3,82 / 3,55	7,63 / 2,48	7,85 / 3,57
Nazivna hladilna zmogljivost za kompresor (za 60Hz)	kW	5,0 (1,1-8,9)	6,0 (3,3-11,9)	11,0 (5,5-14,0)
Razred energijske učinkovitosti 4)		A++/ A++	A++/ A++	A++/ A++
<b>Tehnične lastnosti</b>				
Izvedba			Monoblok	
Sistem			Zrak - voda	
Vrsta operacije			Ogrevanje / hlajenje	
Testirano			EHPA lab	
Inverterska tehnologija			Emerson Copeland Scroll	
Upravljanje sistema			Siemens RVS 21	
Rezervno napajanje			Zunanji	
Nočno delovanje (zatemnitev)			Da, nastavljeni parametri	
Delovno območje vira toplote	°C	-23 do +37	-23 do +37	-23 do +37
Maks. izhodna temperatura kompresorja do -7°C	°C	65	65	65
Najnižja izhodna temperatura med hlajenjem (protitočni kondenzator)	°C	7	7	7
Nazivni pretok vode (ogrevanje) za Δt 5 K	m³/h	1,95	2,34	3,37
Največja zunanja izguba tlaka ogrevalnega sistema	kPa	5,5	6	7
Največji delovni pritisk vode	bar	3	3	3
Priključki za ogrevanje in povratno vodo		zunanj 1 1/4"	zunanj 1 1/4"	zunanj 1 1/4"
Priporočen premer priključne Cu cevi	mm	28	28	28
<b>Hladilni krog</b>				
Hladilno sredstvo 2)		R454B	R454B	R454B
Količina hladilnega sredstva	kg	1,2	1,4	1,6
Hladilni krog			hermetično zaprta	
<b>Mehanske informacije, teža</b>				
Dimenzije	mm	1271 x 600 x 1184	1271 x 600 x 1184	1271 x 600 x 1184
Teža	kg	205	205	205
<b>Električni podatki</b>				
Napajanje kompresorja	V/ Ph/ Hz	230/1~/50	400/3~/50	400/3~/50
Stikalni napajalnik z RVS	V/ Ph/ Hz	230/1~/50	230/1~/50	230/1~/50
Moč za električno bivalentnost	V/ Ph/ Hz	400/3~/50	400/3~/50	400/3~/50
Nazivna poraba energije za hlajenje A7/W35	kW	1,22	1,6	2,04
Tok A7/W35 (toplotna črpalka na fazo)	A	5,3	2,57	3,27
Zaščita zunanje enote (stikalna plošča brez električne bivalence)	A B	1 x 16	3 x 20	3 x 25
Dobava za stikalno ploščo toplotne črpalke CYKY	n x mm3	3 x 2,5	5 x 2,5	5 x 4
<b>Hrupnost</b>				
Zvočna moč LwA, nazivni zvočni tlak LwP 1m	dB(A)	52 / 47	53 / 47	54 / 50
Nazivni zvočni tlak LpA 3) / nočno dušenje	dB(A)	32 / 25	34 / 27	36 / 29

1) Pod pogoji 7°C zraka na vstopu v toplotno črpalke in v vode 35°C na izstopu iz toplotne črpalke. (V skladu z evropskim standardom EN 14511)

2) V skladu z evropskim standardom EN 14825 za povprečne podnebne razmere.

3) Dimenzije kabljskih povezav in velikost varovalk je predvidena za osnovno konfiguracijo toplotne črpalke - kompresor, ventilator, obtočne črpalke in regulacijo.

4) Izračunano za največjo dolžino 25m.



## TOPLOTNA ČRPALKA ZRAK / VODA HOTJET ONE ZET - monoblock inverter - notranja postavitev

Koda	Naziv	Tehnični podatki	Cena
HJ7ZETXn	Hotjet ONE ZET7	A7/W35 : 6,25 / 5,1	10.199,20
EKOHJ10ZETXn	Hotjet ONE ZET10	A7/W35 : 8,04 / 5,02	11.321,60
EKOHJ20ZETXn	Hotjet ONE ZET20	A7/W35 : 10,29 / 5,03	12.431,80

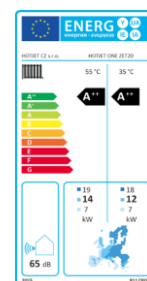
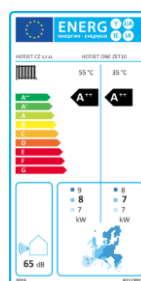
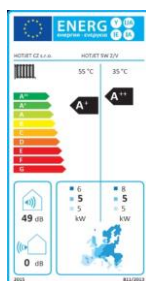

Tehnični podatki	HJ7ZETXn	EKOHJ10ZETXn	EKOHJ20ZETXn
<b>Podatki o učinkovitosti</b>	enota		
Moč ogrevanja (min/max)	Moč ogrevanja [kW] / Poraba energije [kW] / Faktor ogrevanja [COP]		
Ogrevanje: A7/W35 - toplotna moč / priključna moč / grelno število [COP] <sup>1)</sup> kW / kW / -	0,9-8kW	2-10,7kW	3-14,5kW
Ogrevanje: A2/W35 - toplotna moč / priključna moč / grelno število [COP] <sup>1)</sup> kW / kW / -	6,25 / 5,1	8,04 / 5,02	10,29 / 5,03
Ogrevanje: A2/W35 - toplotna moč / priključna moč / grelno število [COP] <sup>1)</sup> kW / kW / -	4,33 / 4,09	6,35 / 4,04	8,33 / 4,11
Ogrevanje: A7/W35 - toplotna moč / priključna moč / grelno število [COP] <sup>1)</sup> kW / kW / -	3,82 / 3,55	5,57 / 3,42	7,85 / 3,57
Nazivna toplotna moč	6	8	10
Hlajenje: A35/W7 hladilna zmogljivost / poraba energije / faktor hlajenja [EER] 1)	4,90 / 2,81		12,20 / 2,65
Hlajenje: A35/W18 hladilna zmogljivost / poraba energije / faktor hlajenja [EER] 1)	5,7 / 3,61		12,77 / 3,81
Hlajenje: A27/W18 hladilna zmogljivost / poraba energije / faktor hlajenja [EER] 1)	5,8 / 3,92		18,2 / 4,11
Hlajenje: nazivna moč	5	6	11
Razred energijske učinkovitosti za 35°C 2)	A++	A++	A++
Razred energijske učinkovitosti za 55°C 2)	A++	A++	A++
<b>Tehnične lastnosti</b>			
Nazivna temperatura vira, območje delovanja [°C]	-23 do 37°C	-23 do 37°C	-23 do 37°C
Nazivna temperatura odjema min./max. [°C]		20 do 65°C (do -10°C)	20 do 65°C (do -10°C)
Delovno območje hlajenja	15 do 45°C	15 do 45°C	15 do 45°C
Priključki za ogrevanje in povratno vodo	1 1/4"	1 1/4"	1 1/4"
Nominalni pretok ogrevalne vode [m3 . h-1]	1	1,4	1,6
Dispozicijski tlak obtočne črpalke kPa	60	50	40
Zaščita ogrevalne vode pred zamrzitvijo	s spremljanjem temperature krmilnikov		
<b>Hladilni krog</b>			
Ekspanzijski ventil	Emerson EEV	Emerson EEV	Emerson EEV
Hladilno sredstvo	R454B	R454B	R454B
Teža hladilnega sredstva [kg]	1,1	1,3	1,6
Omejitev CO2	0,51t	0,61t	0,75t
Način odmrzovanja	reverzibilno	reverzibilno	reverzibilno
Ogrevanje posode za zbiranje kondenzata	S preostalo toploto hladilne tekočine		
Odvod kondenzata	Po cevi	Po cevi	Po cevi
<b>Dimenzije. Teža</b>			
Širina x globina x višina [mm]	1600 x 1000 x 800	1600 x 1000 x 800	1600 x 1000 x 800
Teža [kg]	180	200	220
Postavitev	notranja	notranja	notranja
Zaščita proti koroziji	Pocinkana pločevina + poliuretanski premaz		
<b>Električni podatki</b>			
Kompresor	Emerson copeland Scroll Inventor		
Električno napajanje kompresorja	1 x 230V AC, 50Hz	1 x 230V AC, 50Hz	3 x 230/ 400V AC, 50Hz
Električno napajanje el. kotla	3 x 230/ 400V AC, 50Hz	3 x 230/ 400V AC, 50Hz	3 x 230/ 400V AC, 50Hz
Nazivni tok pri A7/W35	5,3	2,57	3,27
Največja moč kompresorja (kW)	3,8	5	8
Varovalke	16B/3 - 400V	16B/3 - 400V	16B/3 - 400V
El. povezava do kompresorja CYKY [n x mm2]	5 x 2,5	5 x 2,5	5 x 4
<b>Hrupnost</b>			
Raven zvočne moči Lwa (dB)	56	58	60
Raven zvočnega tlaka Lpa 5m (dB)	35	38	39
Nočno dušenje, regulacija hitrosti glede na zunanjo temperaturo	da	da	da
<b>Oprema</b>			
Omarica z varnostnimi in regulacijskimi elementi	zunanja	zunanja	zunanja
Integrirana električna kartuša	da	da	da
Integrirana obtočna črpalka	da	da	da
Krmilni regulator	Siemens RVS21	Siemens RVS21	Siemens RVS21
Zunanji senzor	da	da	da
Daljnisko upravljanje preko interneta	webserver	webserver	webserver

1) Pod pogoji 7°C zraka na vstopu v toplotno črpalko in vode 35°C na izstopu iz toplotne črpalke. (V skladu z evropskim standardom EN 14511)

2) V skladu z evropskim standardom EN 14825 za povprečne podnebne razmere.



## TOPLITNA ČRPALKA ZRAK / VODA HOTJET ONE 2



Koda	Naziv	Moč (kW)	Cena
HOTJET20ONE2	Hotjet 20 ONE2	A7/W35 : 18,81 / 4,18 / 4,50	10.394,40
HOTJET25ONE2	Hotjet 25 ONE2	A7/W35 : 30,10 / 6,99 / 4,30	17.921,80
HOTJET45ONE2	Hotjet 45 ONE2	A7/W35 : 40,20 / 9,10 / 4,42	22.265,00

Ogrevanje do 63°C,  
(opcija - aktivno hlajenje  
Hydrobox), el. omarica  
s Siemens regulacijo,  
sobna / kontrolna enota  
QAA75, EC ventilator,  
Danfoss softstarter

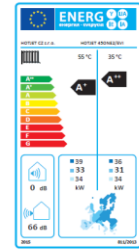
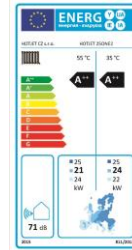
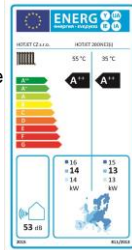

Tehnični podatki	HOTJET20ONE2	HOTJET25ONE2	HOTJET45ONE2
<b>Podatki o učinkovitosti</b>	Moč ogrevanja [kW] / Poraba energije [kW] / Faktor ogrevanja [COP]		
Ogrevanje: A7/W35 1)	18,81 / 4,18 / 4,50	30,10 / 6,99 / 4,30	40,2 / 9,1 / 4,42
Ogrevanje: A2/W35 1)	15,62 / 4,21 / 3,71	25,20 / 6,43 / 3,62	33,60 / 8,85 / 3,74
Ogrevanje: A-7/W35 1)	11,66 / 3,7 / 3,15		
Ogrevanje: A-7/W55 1)	16,91 / 5,79 / 2,92	29,99 / 10,99 / 2,73	40,1 / 14,32 / 2,8
Ogrevanje: A-2/W55 1)	14,48 / 5,74 / 2,52	25,73 / 10,90 / 2,36	34,35 / 14,08 / 2,44
Ogrevanje: A-7/W55	12,29 / 5,66 / 2,17	21,94 / 10,74 / 2,04	29,21 / 13,66 / 2,14
Razred energijske učinkovitosti 35°C 2)	A++	A++	A++
Razred energijske učinkovitosti 55°C 2)	A+	A++	A+
Hlajenje: A35/W7 4)	14,00 / 5,80 / 2,40	22	28,32 / 11,79 / 2,4
<b>Tehnični podatki</b>			
Nazivna temperatura vira, območje delovanja [°C]	-22 do 40°C	-22 do 40°C	-22 do 40°C
Nazivna temperatura odjema min./max. [°C]	20 do 62°C (do -10°C)	20 do 62°C (do -10°C)	20 do 62°C (do -10°C)
Priključki na toplotni črpalki	G 5/4" ZN	G 5/4" ZN	G 5/4" ZN
Nominalni pretok na strani segrevanja Δt = 5 °C [m <sup>3</sup> · h <sup>-1</sup> ]	3,37	5,18	7,64
Minimalni pretok na strani segrevanja Δt = 7 °C [m <sup>3</sup> · h <sup>-1</sup> ]	2,4	3,69	5,46
Padec tlaka [kPa]	7	9	10,3
Koeficient pretoka Kvs [-]	12,7	17,2	-
Zaščita ogrevalne vode pred zamrzitvijo	Da (mora biti priključena na el. omrežje)		
Pretok zraka [m <sup>3</sup> · h <sup>-1</sup> ]	5000	8400	12300
Ekspanzijski ventil	Elektronsko nadzorovan: 1 x glavni, 1 x vbrizg plina EVI		
Z EVI vbrizgom plina	Da	Da	Da
Plin	R407C	R407C	R407C
Odtaljevanje	Samodejno ali na zahtevo		
Količina plina	5	11,5	15,4
Način odtaljevanja	Z vročim plinom (vzratno ogrevalni krog) * v primeru hlajenja 11,5kg v 25 ONE2		
Ogrevanje lovilne posode za kondenz	S preostaloto toploto plina		
Odvod kondenza [mm]	Ø30	Ø30	Ø30
Ogrevanje odtočne cevi za kondenz	Optimizirana funkcija v regulaciji pripravljena		
Stikalo za nizek tlak (izklop) [MPa]	0,05	0,05	0,05
Stikalo za visok tlak (izklop) [MPa]	3,2	3,2	3,2
<b>Dimenzije, teža</b>			
Širina x globina x višina [mm]	1270 x 500 x 1210	1621 x 600 x 1483	1721 x 700 x 1680
Teža [kg]	205	250	370
Mesto montaže	Zunanja (po prilagoditvi notranja)		
Ohišje	Barvana z poluteranskim UV odpornim lakom. Pocinkana pločevina		
Barva	RAL 7016 (možna zamenjava barve)		
Nazivna napetost	400V / 3 fazna / 50Hz		
Kompresor	Scroll EVI		
Nazivni tok A7/W35 [A]	8,4	11,2	16,4
Max. trenutni tok [A]	16,5	22	30
Zagonski tok [A]	73	80	96
Zagonski tok z mehkim zaganjačem	43,8	48	58
Varovalke za kompresor z mehkim zaganjačem	20C/3	25C/3	32C/3
Varovalke	25B/3	32B/3	40C/3
El. povezava do kompresorja CYKY [n x mm <sup>2</sup> ] 3)	5 x 6	5 x 10	5 x 10
<b>Električni podatki v kombinaciji z Hydrobox</b>			
Glavne varovalke za toplotno črpalko s Hydrobox	25C/3	32C/3	-
El. povezava do toplotne črpalke s Hydrobox CYKY [n x mm <sup>2</sup> ] 4)	5 x 4	5 x 6	-
Stopnja zaščite IPX (EN 60 529)	Z nameščeno nadzorno ploščo IP40		
<b>Hrupnost</b>	Po EN 12 102 pri A7 / W55 (najvišja zmogljivost)		
Nivo hrupa Lwa [dB]	max: 67	max: 71,5	max 76,5
Pritisk hrupa na Lpa 5 m [dB]	48	52,5	57,5
EC ventilator	630mm	800mm	900mm
Spremenljiva hitrost ventilatorja	Gladko, z regulacijo 0-10V signal. Funkcije: glede na temperaturo, nočno delovanje itd..		
Nadzor hrupa in zmogljivosti s spremembami hitrosti ventilatorja	Neprekinjeno, od regulacije s signalom 0-10V		
<b>Oprema</b>			
Električna kovinska omarica z regulacijo	Zunanja ( 398 x 647 x 166 - š/v/g ) 16 kg		
Kontrolna enota	po izbiri AVS37 ali AVS74		
Električni kabel (med zunanjo enoto in krmilno omarico)	5m v sklopu zunanje enote (do 25m poskrbljeno za zaščito, nad 25m je potreben ponoven izračun)		
Siemens regulacija	RVS21+ razširitevni AVS55.199 + AVS75.370	RVS21 + razširitevni modul AVS55.196	
Raztezni ekspanzijski ventil	Z regulacijo RVS21 Neodvisna regulacija: Carel ali Emerson		
Kontrola faz	Da (pri RVS21 zunanja, RVS61 notranja)		
Sobna kontrolna enota (žična)	QAA75 (žična), QAA78 (brežžična)		
Zunanje tipalo	Dodatno (QAC34)		
Upravljanje preko interneta	Da (z webserverjem za 1, 4 ali 16 regulacij)		
Kaskada	Do 16 enot (RVS21 z povezovalnim modulom, RVS61 standardno)		
MODBUS komunikacija	Da (z razširitevni Modbus komunikacijskim modulom)		

- Pod pogoji 7°C zraka na vstopu v toplotno črpalko in vode 35°C na izstopu iz toplotne črpalke. (V skladu z evropskim standardom EN 14511)
- V skladu z evropskim standardom EN 14825 za povprečne podnebne razmere.
- Dimenzije kablskih povezav in velikost varovalk je predvidena za osnovno konfiguracijo toplotne črpalke - kompresor, ventilator, obtočne črpalke in regulacijo.
- Izračunano za največjo dolžino 25m.



### TOPLLOTNA ČRPALKA ZEMLJA / VODA HOTJET W - inverter

Koda	Naziv	Tehnični podatki	Cena
HJB7WX	HOTJET5W	B0/W35: moč 3,7 kW poraba energije: 0,73 kW, COP 5,1	7.795,80
HJB10WX	HOTJET10W	B0/W35: moč 5,3 kW poraba energije: 1,07 kW, COP 4,95	8.332,60
EKOHJB15WX	HOTJET15W	B0/W35: moč 7,97 kW poraba energije: 1,65 kW, COP 4,8	9.357,40
EKOHW33H	HOTJET33W	B0/W35: moč 28,57 kW poraba energije: 6,1 kW, COP 4,7	12.907,60

Ogrevanje, aktivno hlajenje (opcija), pasivno hlajenje, Siemens regulacija

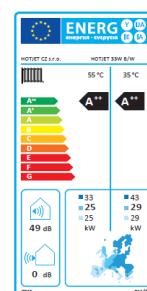
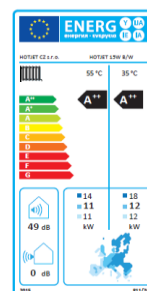
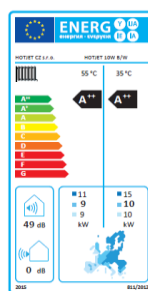
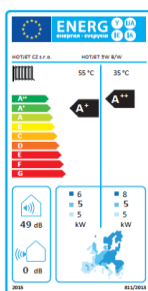

### TOPLLOTNA ČRPALKA VODA / VODA HOTJET W - inverter

Koda	Naziv	Tehnični podatki	Cena
EKOHW7WX	HOTJET5W	W10/W35: moč 4,7 kW poraba energije: 0,7 kW, COP 6,4	7.978,80
EKOHW10WX	HOTJET10W	W10/W35: moč 6,3 kW poraba energije: 0,98 kW, COP 6,4	8.479,00
EKOHW15WX	HOTJET15W	W10/W35: moč 9,46 kW poraba energije: 1,52 kW, COP 6,2	9.491,60

Ogrevanje, aktivno hlajenje (opcija), pasivno hlajenje, Siemens regulacija

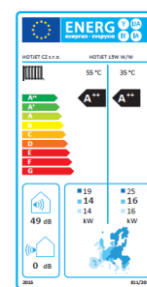
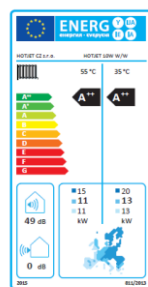
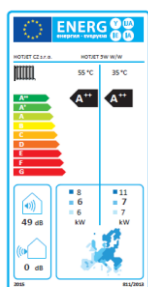

Tehnični podatki	HJB 7WX	HJB 10WX	EKO HJB 15WX	EKO HJW 33H	EKO HJW 7WX	EKO HJW 10WX	EKO HJW 15WX
<b>Podatki o učinkovitosti</b>							
Moč ogrevanja [kW] / Poraba energije [kW] / Faktor ogrevanja W [COP]							
Ogrevanje: B0/W35 zemlja-voda: ogrevalna moč / vhodna moč / COP 1)	3,7 / 0,73 / 5,1	5,3 / 1,07 / 4,95	7,97 / 1,65 / 4,8	28,57 / 6,1 / 4,7			
Ogrevanje: B0/W35 zemlja-voda: Pdesign / SCOP 2)	9,09 / 5,76	12,62 / 5,77	19,18 / 5,55				
Ogrevanje: B0/W35 zemlja-voda: obseg delovanja	2,6 - 9,4	3,6 - 13	5,5 - 19,7				
Ogrevanje: B0/W55 zemlja-voda: ogrevalna moč / vhodna moč / COP 1)	4,7 / 1,38 / 3,4	6,5 / 1,97 / 3,3	9,92 / 3,18 / 3,1	25,29 / 9,1 / 2,78			
Ogrevanje: B0/W55 zemlja-voda: Pdesign / SCOP 2)	8,55 / 4,28	11,87 / 4,28	18,05 / 4,21				
Ogrevanje: B0/W55 zemlja-voda: obseg delovanja	3 - 8,8	4,1 - 12	6,3 - 18,1				
Ogrevanje: W10/W35 voda-voda: ogrevalna moč / COP 1)	4,5 / 0,7 / 6,4			4,5 / 0,7 / 6,4	6,3 / 0,98 / 6,4	9,46 / 1,52 / 6,2	
Ogrevanje: W10/W35 voda-voda: Pdesign / SCOP 2)	9,19 / 7,44			9,19 / 7,44	12,77 / 7,45	19,41 / 7,28	
Ogrevanje: W10/W35 voda-voda: obseg delovanja	4 - 11 4,4 - 15,2 7 - 23			4 - 11 4,4 - 15,2 7 - 23	4,4 - 15,2	7 - 23	
Ogrevanje: W10/W55 voda-voda: ogrevalna moč / COP 1)	5,5 / 1,47 / 3,73			5,5 / 1,47 / 3,73	7,7 / 2,09 / 3,68	9,65 / 2,69 / 3,58	
Ogrevanje: W10/W55 voda-voda: Pdesign / SCOP 2)	9,16 / 5,64			9,16 / 5,64	12,72 / 5,66	19,33 / 5,51	
Ogrevanje: W10/W55 voda-voda: obseg delovanja	4 - 10,5			4 - 10,5	5 - 14	7,2 - 20,5	
Razred energijske učinkovitosti 35°C / 55°C	A+++ / A+++			A+++ / A+++	A+++ / A+++	A+++ / A+++	A+++ / A+++
<b>Tehnični podatki</b>							
Delovno območje vira toplote: voda °C	>3	>3	>3	>3	>3	>3	>3
Delovno območje vira toplote: zemlja °C	-10 do +30 (antifriz)						
Izhodna temperatura ogrevalne vode min / maks °C	15 do +60	15 do +60	15 do +60	15 do +55	15 do +60	15 do +60	15 do +60
Priključki na toplotni črpalke	zunanj G1"	zunanj G1"	zunanj G1"	zunanj G1"	zunanj G1"	zunanj G1"	zunanj G1"
<b>Sekundarni krog</b>							
Pretok vode skozi ogrevalni krog Δt = 5 °C (m³, h-1)	1,25	1,25	1,25		1,25	2,26	2,79
Najmanjši prostorninski pretok na ogrevalni strani Δt = 7 °C (m³, h-1)	0,9	0,9	0,9		0,9	1,59	2
Priključki na toplotni črpalke	zunanj G1"	zunanj G1"	zunanj G1"		zunanj G1"	zunanj G1"	zunanj G1"
Zaščita ogrevalne vode pred zamrzitvijo	Da (dodatna regulacijska elektronika)						
<b>Hladilni krog</b>							
Ekspanzijski ventil	Elektronsko krmiljen						
Hladilno sredstvo	R410A / R454B	R410A / R454B	R410A / R454B	R410A / R454B	R410A / R454B	R410A / R454B	R410A / R454B
Teža polnjenja (hladilno sredstvo) kg	1,3	1,3	1,3	3,2	1,3	1,4	1,5
Izklopni tlak visokotlačnega stikala Mpa	4,5	4,5	4,5	3	4,5	4,5	4,5
<b>Tehnični podatki (mere, teža)</b>							
Širina x globina x višina [mm]	600 x 700 x 1 000	600 x 700 x 1 000	600 x 700 x 1 000	1123 x 647 x 1166	600 x 700 x 1 000	600 x 700 x 1 000	600 x 700 x 1 000
Teža [kg]	130	130	130	175	130	135	140
Mesto montaže	Notranja	Notranja	Notranja	Notranja	Notranja	Notranja	Notranja
Zaščita ohišja	Komaxit	Komaxit	Komaxit	Komaxit	Komaxit	Komaxit	Komaxit
Barva	RAL 7035	RAL 7035	RAL 7035	RAL 7035	RAL 7035	RAL 7035	RAL 7035
<b>Električni podatki</b>							
Nazivna napetost	230V / 1 faza / 50Hz	230V / 1 faza / 50Hz	230V / 1 faza / 50Hz	400V / 3 faze / 50Hz	230V / 1 faza / 50Hz	400V / 3 faze / 50Hz	
Kompresor	Copeland Variable Speed Scroll						
Max. trenutni tok B0/W55 [A]		7,19	8,53	22,2		7,19	8,53
Zaščita dovoda toplotne črpalke	16B / 1	16B / 1	16B / 1	25C / 3	16B / 1	20B / 3	20B / 3
El. povezava do toplotne črpalke CYKY [n x mm²]	3 x 4	3 x 4	3 x 4	5 x 6 (rez.5,3kW/400W)	3 x 4	5 x 4	5 x 4
Stopnja zaščite IPX ( EN 60 529 )	IP21	IP21	IP21	IP21	IP21	IP21	IP21
<b>Hrupnost</b>							
Raven zvočne moči LWA B0/W55 (2275rpm) dB	40,7	40,7	40,7	< 53	40,7	40,7	40,7
<b>Oprema</b>							
Električna kovinska omarica z regulacijo	V napravi	V napravi	V napravi	Ločena (proti doplačilu) / v napravi	V napravi	V napravi	V napravi
Vgrajena obtočna črpalka za drugi krog	UPM3K 15-75	UPM3K 15-75	UPM3K 15-75		UPM3K 15-75	UPM3K 15-75	UPM3K 15-75
Integrirano pretočno stikalo za primarni krog	senzor PT1000	senzor PT1000	senzor PT1000		senzor PT1000	senzor PT1000	
Integrirano pretočno stikalo za sekundarni krog	senzor PT1000	senzor PT1000	senzor PT1000		senzor PT1000	senzor PT1000	
Siemens regulacija	RVS21 + AVS55	RVS21 + AVS55	RVS21 + AVS55	RVS21 + AVS55	RVS21 + AVS55	RVS21 + AVS55	RVS21 + AVS55
Nadzorna plošča	AVS74	AVS74	AVS74	AVS37 / QAA74	AVS74	AVS74	AVS74
Zunanje tipalo	QAC34	QAC34	QAC34	QAC34	QAC34	QAC34	QAC34
Žični krmilnik	QAA74	QAA74	QAA74	QAA75 / QAA55	QAA74	QAA74	QAA74
Daljiško upravljanje preko interneta OZW672	Neobvezno z 2-letno garancijo, obvezno s 5-letno garancijo			Da (z webserverjem za 1, 4 ali 16 regulacij)	Neobvezno z 2-letno garancijo, obvezno s 5-letno garancijo		
MODBUS komunikacija	Da (z razširjenim Modbus komunikacijskim modulom)						
1) V skladu s standardom EN 14511							
2) V skladu s standardom EN 14511 za hladno cono							
3) V skladu s standardom ČSN EN 14825							

NADZOR PREKO INTERNETA SIEMENS

<b>OCI345.06</b>	<b>OCI351.1</b>	<b>OZW672.01</b>	<b>OZW672.04</b>	<b>AVS75.391</b>	<b>AVS75.370</b>
LPB modul (za kaskadno povezavo RVS21)	LPB Modbus modul (za kaskadno povezavo RVS21)	WEB server - možen nadzor toplotne črpalke, upravljanje preko interneta	WEB server - možen nadzor do 4-ih toplotnih črpalk, upravljanje preko interneta	Razširitveni modul	Razširitveni modul
<b>150,06</b>	<b>189,10</b>	<b>600,24</b>	<b>1.273,68</b>	<b>314,76</b>	<b>331,84</b>

<b>QAA58COOLSOLO</b>	<b>QAA55.110/301</b>	<b>QAA2030</b>	<b>RGQ74</b>	<b>RGA74</b>	<b>RGA37</b>
Sobna enota QAA58.301/701	Sobna enota (hlajenje) QAA55	Sobni senzor	Napredna sobna enota QAA74	Kontrolna enota QAA74	Kontrolna plošča (odprodaja)
<b>240,34</b>	<b>158,60</b>	<b>56,12</b>	<b>363,56</b>	<b>265,96</b>	<b>265,96</b>

<b>AVS71.393/101</b>	<b>AVS71.390/109</b>	<b>OCI700.1</b>
Brezžični sprejemnik AVS71.393	Brezžični sprejemnik AVS71.390 (odprodaja)	Servisno orodje
<b>206,18</b>	<b>206,18</b>	<b>605,12</b>

<b>QAC34</b>	<b>QAD36/101</b>	<b>QAZ36.522/109</b>	<b>QAZ36.526</b>	<b>QAZ36.481</b>
Zunanje tipalo QAC34	Naležno tipalo QAD36/101 (odprodaja)	Tipalo QAZ36 kabel dolžina 2m	Tipalo QAZ36 kabel dolžina 6m	Tipalo za solar QAZ36 OEM NTC10k -30°C do 200°C, kabel dolžina 1,5m
<b>30,50</b>	<b>42,70</b>	<b>24,40</b>	<b>36,60</b>	<b>70,76</b>

ELEKTRIČNI GRELCI

<b>EK75</b>	<b>3000-0092</b>	<b>GRELECPRET</b>
Električni pretočni grelec HOTJET 7,5kW	Pretočni električni grelec 3-6-9 kW, brez regulacije	Grelec pretočni 2-4-6 kW
<b>567,30</b>	<b>256,20</b>	<b>378,20</b>

\*Po naročilu

## KOMBINIRANI TLAČNI BOJLER SGW(S) NEPTUN KOMBI - viseči

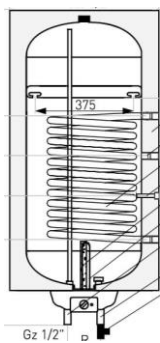

Koda	EAN	Volumen (l)	Izmenjevalec (m <sup>2</sup> )	Višina (mm)	Premer (mm)	Cena
<b>06-084670</b>	5901224415432	80	desni 0,6	920	480	<b>454,69</b>
<b>06-084671</b>	5901224415449	80	levi 0,6	920	480	<b>454,69</b>
<b>06-104670</b>	5901224415456	100	desni 0,6	1080	480	<b>484,58</b>
<b>06-104671</b>	5901224415463	100	levi 0,6	1080	480	<b>484,58</b>
<b>06-124670</b>	5901224414817	120	desni 0,95	1200	480	<b>551,07</b>
<b>06-124671</b>	5901224416897	120	levi 0,95	1200	480	<b>551,07</b>
<b>06-144670 *</b>	5901224420054	140	desni 0,95	1340	480	<b>565,59</b>
<b>06-144671 *</b>	5901224416392	140	levi 0,95	1340	480	<b>565,59</b>

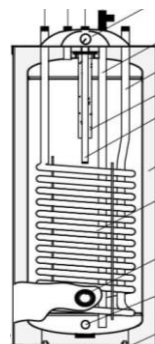

## KOMBINIRANI TLAČNI BOJLER SGW(S) VULCAN KOMBI - viseči

Koda	EAN	Volumen (l)	Izmenjevalec (m <sup>2</sup> )	Višina (mm)	Premer (mm)	Cena
<b>26-105600 *</b>	5901224407598	100	1,2	1050	455/455	<b>664,66</b>
<b>26-125600 *</b>	5901224422423	120	1,2	1150	455/455	<b>705,53</b>
<b>26-145600 *</b>	5901224414589	140	1,2	1300	455/455	<b>741,15</b>



## KOMBINIRANI TLAČNI BOJLER SGW(S) VULCAN KOMBI - stoječi

Koda	EAN	Volumen (l)	Izmenjevalec (m <sup>2</sup> )	Višina (mm)	Premer (mm)	Cena
<b>26-105500 *</b>	5901224416057	100	1,2	1050	455/455	<b>664,66</b>
<b>26-125500 *</b>	5901224407604	120	1,2	1150	455/455	<b>705,53</b>
<b>26-145500 *</b>	5901224413995	140	1,2	1300	455/455	<b>741,15</b>
<b>26-205500 *</b>	5901224531941	200	1,6	1190	650/650	<b>1.002,11</b>

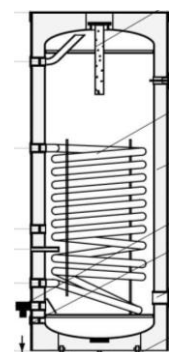

## KOMBINIRANI TLAČNI BOJLER SGW(S) MINI TOWER - stoječi

Koda	EAN	Volumen (l)	Izmenjevalec (m <sup>2</sup> )	Višina (mm)	Premer (mm)	Cena
<b>26-108000 *</b>	5901224420641	100	0,6	1040	518	<b>554,86</b>
<b>26-128000 *</b>	5901224419027	120	0,95	1150	518	<b>593,41</b>
<b>26-148000</b>	5901224417481	140	0,95	1290	518	<b>644,77</b>

\*Po naročilu

## BOJLER SG(S) trda izolacija

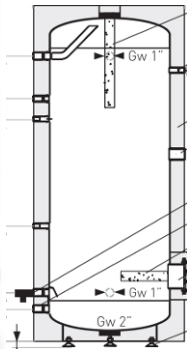

Koda	EAN		Volumen (l)	Cena
<b>22-108000</b>	5901224420641	*	100	<b>477,87</b>
<b>22-128000</b>		*	120	<b>519,11</b>
<b>22-148000</b>		*	140	<b>545,46</b>
<b>22-208000N</b>		*	200	<b>724,56</b>
<b>22-308000N</b>	5901224541513	*	300	<b>924,03</b>
<b>22-408000N</b>		*	400	<b>1.189,87</b>
<b>22-504000N</b>	5901224552496	*	500	<b>1.516,46</b>
<b>22-704000N</b>		*	720	<b>2.373,14</b>
<b>34-104000N</b>		*	1000	<b>3.000,35</b>
<b>34-154000N</b>	5901224545788	*	1500	<b>4.004,41</b>

## BOJLER SGW(S) TOWER z enim izmenjevalcem trda izolacija



Koda	EAN	Volumen (l)	Izmenjevalec spodnji (m <sup>2</sup> )	Višina in prekučna višina (mm)	Premer brez / z izolacijo (mm)	Cena
<b>TOWER trda izolacija 70mm</b>						
<b>26-208000</b>	5901224540677	200	1,4	1100	670	<b>890,67</b>
<b>26-308000N</b>	5901224558467	300	1,4	1615	670	<b>1.106,82</b>
<b>26-408000N</b>	5901224563706	400	1,8	1660/1700	700/800	<b>1.384,21</b>
<b>26-504000N</b>	5901224559884	500	1,8	1890/1940	700/800	<b>1.720,57</b>
<b>BIG TOWER trda izolacija 70mm</b>						
<b>26-704000N *</b>	5901224566059	720	2,4	2050/2080	855/900	<b>2.581,89</b>
<b>BIG TOWER mehka izolacija 100mm</b>						
<b>26-704600 *</b>		720	2,4	2050/2080	855/900	<b>2.581,89</b>
<b>36-104600 *</b>		1000	2,7	1960/1990	1055/1100	<b>3.191,64</b>
<b>36-154600 *</b>		1500	2,7	2650/2680	1055/1100	<b>4.404,44</b>

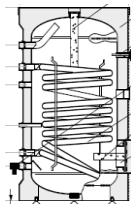

200 l

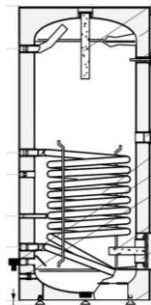

250-300 l

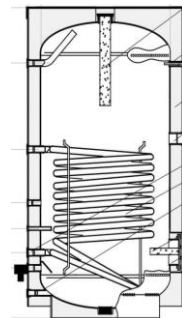

big tower 800-1000 l

## BOJLER SGW(S) B TOWER BIWAL Z DVEMA IZMENJEVALCEMA - trda izolacija



Koda	EAN	Volumen (l)	Izmenjevalec (m <sup>2</sup> ) zgornji - spodnji (sonč.kolekt.)		Višina in prekučna višina (mm)	Premer brez / z izolacijo (mm)	Cena
<b>26-209000</b>	5901224518478	200	0,7	1,0	1140	670	<b>1.103,66</b>
<b>26-309000N</b>	5901224558474	300	1,1	1,4	1615	670	<b>1.219,07</b>
<b>26-409000N</b>	5901224558481	400	1,1	1,8	1750	700	<b>1.476,57</b>
<b>26-509000N</b>	5901224558498	500	1,1	2,0	1950	700	<b>1.752,16</b>
<b>26-709000N *</b>	5901224580666	720	1,2	2,4	2050/2220	700/855	<b>2.658,62</b>
<b>36-109600N *</b>	5901224538278	1000	1,5	2,7	1960/2230	900/1055	<b>3.326,94</b>
<b>36-159600N *</b>		1500	1,5	2,7	2650/2860	900/1055	<b>4.509,36</b>

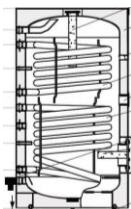

200 l

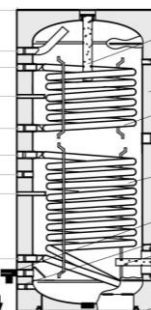

250 - 500 l

\*Po naročilu

## BOJLER ZA TOPLOTNO ČRPALKO SGW(S) MAXI Z VEČJIM IZMENJEVALCEM - trda izolacija



Koda	EAN	Volumen (l)	Izmenjevalec zgornji (m <sup>2</sup> )	Višina in prekucna višina (mm)	Premer z izolacijo (mm)	Cena
<b>26-258500N</b>	5901224544439	250	2,9	1300	670	<b>1.520,49</b>
<b>26-308500N</b>	5901224558504	300	3,6	1615	670	<b>1.600,64</b>
<b>26-408100N</b>	5901224558511	400	5,0	1750	700	<b>1.925,65</b>
<b>26-504100N</b>	5901224561726	500	6,0	1950	755	<b>2.335,69</b>
<b>26-704100N</b>	5901224563898	700	605,0	2050	855	<b>3.924,01</b>

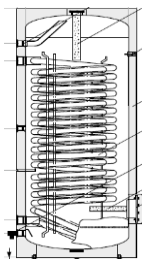

250-500 l

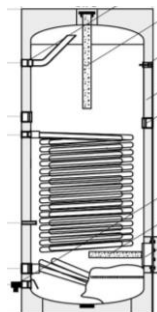

720-1000 l

## BOJLER ZA TOPLOTNO ČRPALKO SGW(S) TOWER GRAND



Koda	EAN	Volumen (l)	Izmenjevalec zgornji (m <sup>2</sup> )	Višina in prekucna višina (mm)	Premer z izolacijo (mm)	Cena
<b>26-168107 *</b>	5901224579875	160	1,4	1140	670	<b>869,01</b>
<b>26-208107</b>	5901224583117	200	2,0	1320	670	<b>1.103,25</b>
<b>26-308107N</b>	5901224587313	300	2,7	1615	670	<b>1.455,22</b>
<b>26-408107N *</b>	5901224583964	400	4,1	1750	700	<b>1.701,41</b>
<b>26-504107N *</b>	5901224579776	500	4,3	1950	755	<b>2.084,37</b>

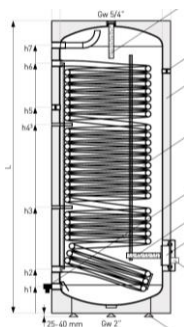

160-500 l

## BOJLER ZA TOPLOTNO ČRPALKO SGW(S)B MAXI PLUS Z DVEMA VEČJIMA IZMENJEVALCEMA - trda izolacija



Koda	EAN	Volumen (l)	Izmenjevalec (m <sup>2</sup> )		Višina (mm)	Premer z izolacijo (mm)	Cena
			zgornji toplotna črpalka (m <sup>2</sup> )	spodnji sončni kolektor (m <sup>2</sup> )			
<b>26-309100N</b>	5901224561733	300	2,2	1,0	1480	670	<b>1.925,65</b>
<b>26-409100N *</b>	5901224566202	400	3,8	1,5	1660	700	<b>2.140,00</b>
<b>26-509100N *</b>		500	4,8	1,8	1890	700	<b>2.581,76</b>

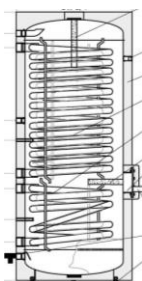

300-500 l



Izmenjevalec v dveh špiralah

\*Po naročilu

## ELEKTRIČNI GRELCI za bojlerje



Koda	EAN	Naziv	Moč (kW)	Napetost (V)	Priklj. uček	Cena
<b>41-020001EX</b>	5901224814709	Električni grelec	2	230	5/4"	<b>73,24</b>
<b>41-030001EX</b>	5901224830631	Električni grelec	3	230	5/4"	<b>88,30</b>
<b>41-020011EX</b>	5901224814716	Električni grelec	2	230	6/4"	<b>73,24</b>
<b>41-030011EX</b>	5901224830648	Električni grelec	3	230	6/4"	<b>93,40</b>
<b>41-045011</b>	5901224841040	Električni grelec	4,5	400	6/4"	<b>340,06</b>
<b>41-060011</b>	5901224841057	Električni grelec	6	400	6/4"	<b>358,99</b>



Koda	EAN	Naziv	Moč (kW)	Napetost (V)	Priklj. uček	Cena
<b>GB01.2054</b>		V.Električni grelec 2kW 5/4"	2	230	5/4"	<b>73,57</b>
<b>GB01.2064</b>		V.Električni grelec 2kW 6/4"	2	230	6/4"	<b>73,57</b>
<b>GB01.3054</b>		V.Električni grelec 3kW 5/4"	3	230	5/4"	<b>88,30</b>
<b>GB01.3064</b>		V.Električni grelec 3kW 6/4"	3	230	6/4"	<b>93,40</b>



## PRIROBNICA za bojler

Koda	EAN	Naziv	Priključek	Cena
<b>40-300230</b>		Prirobnica 180mm z mufno	6/4"	<b>58,80</b>

## POTOPNA TULKA za tipalo



Koda	EAN	Naziv	Cena
<b>14880</b>		Potopna tulka za 1 tipalo 1/2"- 7 x 9 x 100	<b>7,61</b>
<b>14881</b>	8595222651113	Potopna tulka za 1 tipalo 1/2"- 7 x 9 x 200	<b>13,91</b>
<b>15744</b>	8595222657450	Potopna tulka za 3 tipala 1/2"- 13,5 x 16 x 100	<b>8,23</b>
<b>15743</b>	8595222657443	Potopna tulka za 3 tipala 1/2"- 13,5 x 16 x 230	<b>15,65</b>
<b>14882</b>	8595222651120	Potopna tulka za 4 tipala 1/2"- 15 x 17 x 120	<b>8,75</b>
<b>M-010085</b>	5901224070075	Potopna tulka 1/2" dolž. 350mm (40 - 80 litrov)	<b>17,26</b>
<b>M-013178</b>	5901224070075	Potopna tulka 1/2" dolž. 700mm (100-140 litrov)	<b>22,51</b>



## MALI ZALOGOVNICI ZA TOPLOTNE ČRPALKE GALMET SG(B) zidna montaža - GRETJE / HLAJENJE

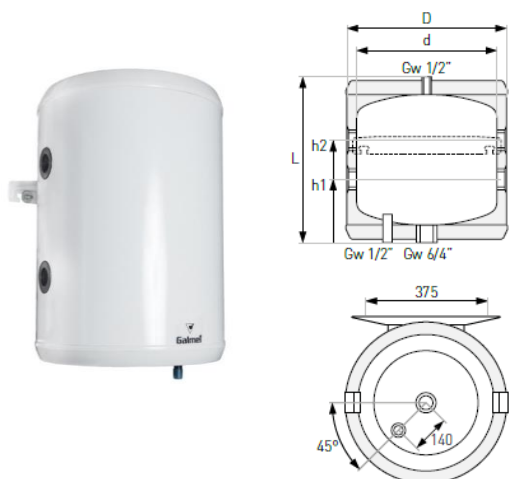

Koda	EAN	Volumen (l)	Višina (mm)	Premer (mm)	Cena
<b>70-067000</b>	5901224337307	63	680	460	<b>262,54</b>
<b>70-087000 *</b>		86	865	460	<b>301,58</b>
<b>70-107000</b>	5901224337321	106	1015	460	<b>336,23</b>
<b>70-127000 *</b>		118	1115	460	<b>373,56</b>
<b>70-147000 *</b>		136	1265	460	<b>407,60</b>

## MALI ZALOGOVNICI ZA TOPLOTNE ČRPALKE G. LEON - GRETJE

Koda	Naziv	Volumen (l)	Višina (mm)	Premer (mm)	Cena
<b>Z40 *</b>	Zalogovnik Leon 40 L CK stenski				<b>173,24</b>
	1x pritrdilna konzola na zadnji strani	40	450	450	
<b>Z50</b>	Zalogovnik Leon 50 L CK stenski				<b>181,05</b>
	1x pritrdilna konzola na zadnji strani	50	510	450	
<b>Z60</b>	Zalogovnik Leon 60 L CK stenski				<b>201,30</b>
	1x pritrdilna konzola na zadnji strani	60	600	450	
<b>Z100</b>	Zalogovnik Leon 100 L CK stenski				<b>232,78</b>
	2x pritrdilna konzola na zadnji strani	100	905	450	
<b>Z100N</b>	Zalogovnik Leon 100 L CK talni				<b>267,42</b>
	Nogice pri talni izvedbi zalogovnika	100	905	450	
<b>Z150N</b>	Zalogovnik Leon 150 L CK talni				<b>321,35</b>
	Nogice pri talni izvedbi zalogovnika	150	1300	450	

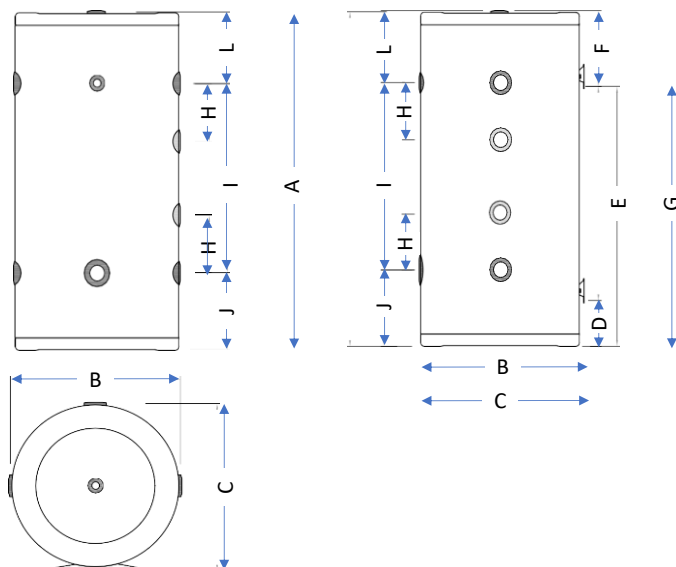

	A	B	C	D	E	F	G	H	I	J	L
<b>40 lit</b>	450	450	460	/	/	185	265	/	95	185	190
<b>60 lit</b>	600	450	460	/	/	190	410	/	210	200	190
<b>80 lit</b>	745	450	460	/	/	190	555	100	365	200	190
<b>100 lit</b>	905	450	460	115	600	190	685	100	530	190	190
<b>120 lit</b>	1080	450	460	120	770	190	990	100	495	200	190
<b>150 lit</b>	1300	450	460	110	995	190	1105	100	925	200	190

## ZALOGOVNIK BREZ IZMENJEVALCA z izolacijo

Koda	EAN	Volumen zalogovnika (l)	Moč kotla (kW)	Teža z izolacijo (kg)	Delovni tlak / max.temp. bar / °C	Višina z izolacijo (mm)	Premer brez / z izolacijo (mm)	Cena
<b>P150</b>		150	6-10	38	3/95	1310	400/500	<b>506,79</b>
<b>P200</b>		200	6-10	47	3/95	1710	400/500	<b>556,56</b>

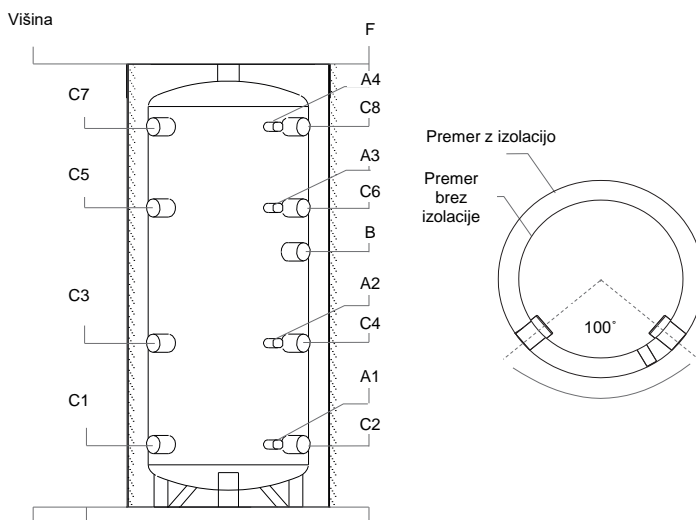

Koda	EAN	Volumen zalogovnika (l)	Moč kotla (kW)	Teža brez / z izolacijo (kg)	Delovni tlak / max.temp. bar / °C	Višina brez / z izolacijo (mm)	Premer brez / z izolacijo (mm)	Cena
<b>P300NI</b>		300	6-10	60/70	3/95	1410/1460	650/750	<b>636,35</b>
<b>P500NI</b>		500	10-17	90/102	3/95	1610/1660	650/850	<b>777,75</b>
<b>P800NI</b>		800	15-27	118/134	3/95	1860/1910	790/990	<b>990,15</b>
<b>P1000NI</b>		1000	18-33	133/151	3/95	2040/2090	790/990	<b>1.091,41</b>
<b>P1500NI</b>		1500	27-50	206/229	3/95	2150/2220	1000/1200	<b>1.716,66</b>
<b>P2000NI</b>		2000	36-67	273/300	3/95	2132/2182	1200/1400	<b>2.081,08</b>

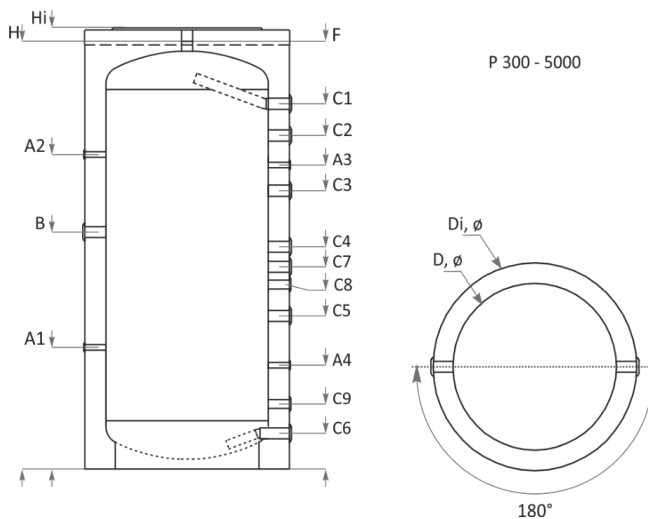

\*Po naročilu

## ZALOGOVNIK ZA OGREVANJE SG(B) 100-5000 L brez izmenjevalca - mehka izolacija



Koda	EAN	Volumen (l)	Višina in prekucna višina (mm)	Premer brez / z izolacijo (mm)	Cena
<b>70-100400</b>	5901224408113	100	1010-trda izolacija	400/500	<b>409,43</b>
<b>70-200000</b>	5901224718328	200	1140-trda izolacija	550/670	<b>562,05</b>
<b>70-300000N</b>	5901224316685	300	1615-trda izolacija	550/670	<b>640,62</b>
<b>70-400000</b>	5901224776014	380	1685-trda izolacija	600/700	<b>798,49</b>
<b>70-500000</b>	5901224791475	500	1925-trda izolacija	600/700	<b>835,58</b>
<b>70-800600</b>	5901224720000	800	1730/1995	790/950	<b>1.105,32</b>
<b>70-100600</b>	5901224720017	1000	2050/2270	790/990	<b>1.225,86</b>
<b>70-150600 *</b>	5901224720024	1500	2700/2920	900/1100	<b>2.102,91</b>
<b>80-200600 *</b>		2000	2500/2820	1100/1300	<b>2.824,18</b>
<b>80-300600 *</b>	5901224725043	3000	2750/3120	1250/1450	<b>4.044,91</b>
<b>80-400600 *</b>		4000	2355/2970	1600/1800	<b>5.180,36</b>
<b>80-500600 *</b>		5000	2855/3380	1600/1800	<b>6.271,17</b>

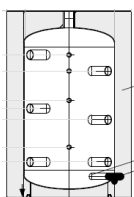

200 l

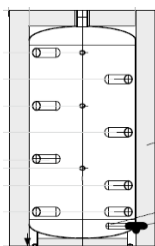

300-2000 l

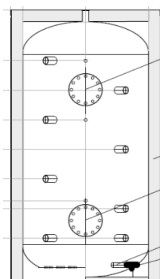

3000-5000 l

## ZALOGOVNIK ZA OGREVANJE SG(B) 200-2000 L z enim izmenjevalcem - mehka izolacija

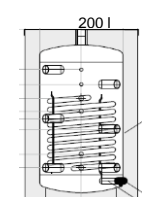

200 l

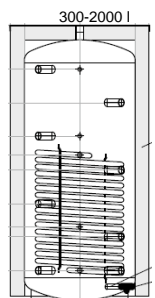

300-2000 l

Koda	EAN	Volumen (l)	Izmenjevalca leč (m <sup>2</sup> )	Višina in prekucna višina (mm)	Premer brez / z izolacijo (mm)	Cena
<b>71-200000</b>	5901224718342	200	1,4	1140-trda izolacija	550/670	<b>705,77</b>
<b>71-300000N</b>	5901224320675	300	1,4	1615-trda izolacija	550/670	<b>785,19</b>
<b>71-400000</b>		380	1,8	1660-trda izolacija	600/700	<b>984,17</b>
<b>71-500000</b>	5901224317385	500	2,5	1925-trda izolacija	600/700	<b>1.049,44</b>
<b>71-800600</b>		800	3,0	1730/1995	790/950	<b>1.495,23</b>
<b>71-100600</b>	5901224720031	1000	3,5	2050/2270	790/990	<b>1.634,19</b>
<b>71-150600 *</b>	5901224720048	1500	4,0	2700/2920	900/1100	<b>2.432,56</b>
<b>81-200600 *</b>		2000	4,5	2500/2820	1100/1300	<b>3.386,72</b>

## ZALOGOVNIK ZA OGREVANJE SG(B) 380-2000 L z dvema izmenjevalcema - mehka izolacija

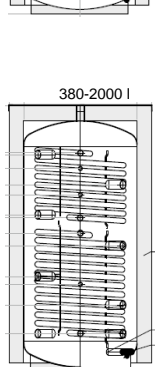

380-2000 l

Koda	EAN	Izmenjevalec (m <sup>2</sup> ) spodnji / zgornji (sončni kolektor)	Volumen (l)	Višina in prekucna višina (mm)	Premer brez / z izolacijo (mm)	Cena
<b>72-400000</b>		1,4 1,8	400	1830-trda izolacija	700	<b>1.266,60</b>
<b>72-500000</b>		1,4 2,5	500	1905-trda izolacija	760	<b>1.352,98</b>
<b>72-800600</b>		1,8 3,0	800	1730/1995	950	<b>1.716,66</b>
<b>72-100600</b>		2,1 3,5	1000	2050/2270	990	<b>1.986,53</b>
<b>72-150600</b>		2,5 4,0	1500	2700/2920	1100	<b>2.850,29</b>
<b>82-200600</b>	5901224317422	2,7 4,5	2000	2500/2820	1300	<b>4.026,12</b>

\*Po naročilu

## ZALOGOVNIK Z INTEGRIRANIM BOJLERJEM SANITARNE VODE BREZ IZMENJEVALCA SG(K) KUMULO - mehka izolacija 10 mm



Koda	EAN	Volumen skupni (l)	Volumen bojlerja (l)	Volumen zalogov. (l)	Višina (mm)	Premer brez / z izolacijo (mm)	Cena
<b>70-506000</b>	*	500	160	340	1670	700/900	<b>2.374,97</b>
<b>70-608000</b>	*	600	200	400	1840	700/900	<b>2.503,93</b>
<b>70-808600</b>	*	800	200	600	1620	900/1100	<b>2.714,01</b>
<b>70-108000</b>	*	1000	200	800	1820	900/1100	<b>2.982,53</b>

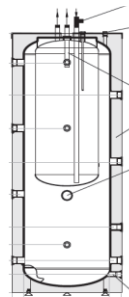

varnostni ventil odzračevanje DN ½"

magnezijeva anoda DN 5/4" izolacija

na električni grelec DN6/4"

izpust vode 1"



mehka izolacija

## ZALOGOVNIK Z INTEGRIRANIM BOJLERJEM SANITARNE VODE Z ENIM IZMENJEVALCEM SG(K) KUMULO - mehka izolacija 10mm



Koda	EAN	Volumen skupni (l)	Volumen bojlerja (l)	Volumen zalogov. (l)	Izmenjev. (m²)	Višina (mm)	Premer brez / z izolacijo (mm)	Cena	
<b>71-506000</b>	5901224702211	500	160	340	2,1	1670	700/900	<b>2.488,19</b>	
<b>71-608000</b>	5901224702228	600	200	400	2,1	1840	700/900	<b>2.724,02</b>	
<b>71-808600</b>	*	800	200	600	2,4	1650	900/1100	<b>3.089,04</b>	
<b>71-108600</b>	*	5901224787621	1000	200	800	2,4	1850	900/1100	<b>3.425,27</b>

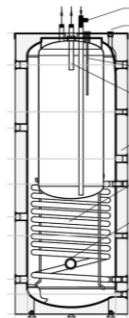

varnostni ventil odzračevanje DN ½"

tipalo

magnezijeva anoda DN 5/4" izolacija

toplotni izmenjevalec za sončno ogrevanje električni grelec DN6/4"

izpust vode 1"



mehka izolacija

## ZALOGOVNIK Z INTEGRIRANIM BOJLERJEM SANITARNE VODE Z DVEMA IZMENJEVALCEMA SG(K) KUMULO - mehka izolacija



Koda	EAN	Volumen skupni (l)	Volumen zalogov. (l)	Izmenjev. zgornji (m²)	Izmenjev. spodnji (m²)	Višina (mm)	Premer brez / z izolacijo (mm)	Cena		
<b>72-506000</b>	*	5901224711510	500	160	340	1,0	2,1	1670	700/900	<b>2.642,64</b>
<b>72-608000</b>	*	600	200	400	400	1,0	2,1	1840	700/900	<b>2.886,76</b>
<b>72-808600</b>	*	800	200	600	600	1,0	2,4	1620	900/1100	<b>3.300,34</b>
<b>72-108600</b>	*	1000	200	800	800	1,0	2,4	1820	900/1100	<b>3.610,71</b>

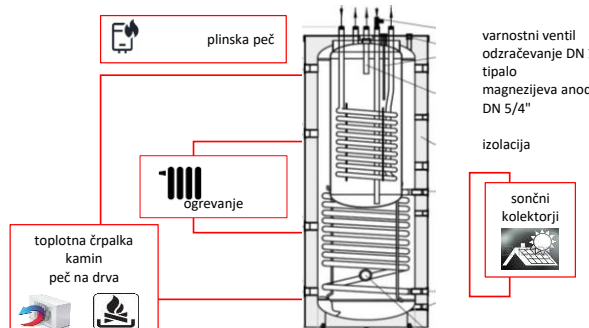

varnostni ventil odzračevanje DN ½"

tipalo magnezijeva anoda DN 5/4"

izolacija



mehka izolacija

\*Po naročilu

## MULTI-INOX ZALOGOVNIK ZA SANITARNO VODO Z INOX IZMENJEVALCEM



Koda	EAN	Volumen zalogovn. (l)	Volumen inox izmenjev.(l)	Izmenjev. sanitarne vode (m <sup>3</sup> )	Višina (mm)	Premer brez / z izolacijo (mm)	Cena
<b>70-601600</b> *		600	39,0	5,65	1900	700/900	<b>2.199,05</b>
<b>70-801600</b> *		800	39,0	5,65	1880	790/990	<b>2.425,36</b>
<b>70-101600</b> *		1000	48,0	6,95	2270	790/990	<b>2.727,43</b>
<b>70-151600</b> *		1500	48,0	6,95	2665	900/1100	<b>3.655,49</b>
<b>80-201600</b> *		2000	56,0	8,0	2500	1100/1300	<b>4.644,54</b>

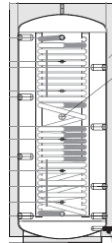

mehka izolacija

## MULTI-INOX ZALOGOVNIK ZA SANITARNO VODO Z INOX IZMENJEVALCEM IN SPODNJIM IZMENJEVALCEM



Koda	EAN	Volumen zalogovn. (l)	Volumen inox izmenjev.(l)	Izmenjev. sanitarne vode (m <sup>3</sup> )	Izmenjev. spodnji (m <sup>2</sup> )	Višina (mm)	Premer brez / z izolacijo (mm)	Cena
<b>71-601600</b> *		600	39,0	5,65	1,4	1900	700/900	<b>3.075,99</b>
<b>71-801600</b> *		800	39,0	5,65	1,8	1880	790/990	<b>3.139,18</b>
<b>71-101600</b> *		1000	48,0	6,95	1,8	2270	790/990	<b>3.310,35</b>
<b>71-151600</b> *		1500	48,0	6,95	3,0	2665	900/1100	<b>3.869,35</b>
<b>80-201600</b> *		2000	56,0	8,0	4,5	2500	1100/1300	<b>4.774,84</b>

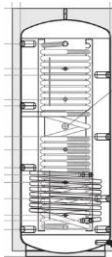

mehka izolacija

## MULTI-INOX ZALOGOVNIK ZA SANITARNO VODO Z INOX IZMENJEVALCEM IN DVEMA IZMENJEVALCEMA



Koda	EAN	Volumen zalogovn. (l)	Volumen inox izmenjev.(l)	Izmenjev. sanitarne vode (m <sup>3</sup> )	Izmenjev. spodnji / zgornji (m <sup>2</sup> )	Višina (mm)	Premer brez / z izolacijo (mm)	Cena
<b>72-601600</b> *	5901224326356	600	39,0	5,65	1,4 / 1,4	1900	700/900	<b>3.236,54</b>
<b>72-801600</b> *		800	39,0	5,65	1,8 / 1,8	1880	790/990	<b>3.318,16</b>
<b>72-101600</b> *		1000	48,0	6,95	1,8 / 1,8	2270	790/990	<b>3.484,56</b>
<b>72-151600</b> *		1500	48,0	6,95	3,0 / 2,4	2665	900/1100	<b>4.109,33</b>
<b>82-201600</b> *		2000	56,0	8,0	4,5 / 3,0	2500	1100/1300	<b>5.073,61</b>

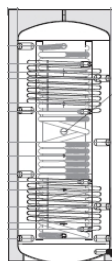

mehka izolacija

\*Po naročilu

## REFLEX N, RAZTEZNE POSODE ZA CENTRALNO OGREVANJE IN HLAJENJE, 4 bar - 120°C, siva

Koda	EAN	Naziv	Premer (mm)	Višina (mm)	Viš. priklj. (mm)	Teža (kg)	Priključek	Cena
<b>8202501</b>	4036705214462	Reflex N8/4	272	236		2,35	R3/4"	<b>47,87</b>
<b>8203301</b>	4036705086564	Reflex N12/4	272	317		2,75	R3/4"	<b>48,27</b>
<b>8204301</b>	4036705086618	Reflex N18/4	308	360		3,60	R3/4"	<b>52,87</b>
<b>8206301</b>	4036705032059	Reflex N25/4	308	477		4,35	R3/4"	<b>62,95</b>
<b>8208401</b>	4036705032066	Reflex N35/4	376	466	130	5,60	R3/4"	<b>87,32</b>

## REFLEX N, RAZTEZNE POSODE ZA CENTRALNO OGREVANJE IN HLAJENJE, 6 bar - 120°C, siva

Koda	EAN	Naziv	Premer (mm)	Višina (mm)	Viš. priklj. (mm)	Teža (kg)	Priključek	Cena
<b>8209300</b>	4036705078590	Reflex N50/6	441	487	175	9,60	R3/4"	<b>116,30</b>
<b>8210200</b>	4036705078613	Reflex N80/6	512	558	172	13,28	R1"	<b>179,33</b>
<b>8216300</b>	4036705078637	Reflex N100/6	512	669	172	15,84	R1"	<b>285,03</b>
<b>8211400</b>	4036705078651	Reflex N140/6	512	890	172	19,90	R1"	<b>333,38</b>
<b>8213300</b>	4036705032394	Reflex N200/6	634	758	205	23,80	R1"	<b>478,14</b>
<b>8214300</b>	4036705110542	Reflex N250/6	634	888	205	24,70	R1"	<b>622,97</b>
<b>8215300</b>	4036705110108	Reflex N300/6	634	1092	235	30,00	R1"	<b>790,79</b>
<b>8218000</b>	4036705110139	Reflex N400/6	740	1102	245	47,00	R1"	<b>864,34</b>
<b>8218300</b>	4036705110153	Reflex N500/6	740	1321	245	52,00	R1"	<b>1.025,26</b>
<b>8218400</b>	4036705110177	Reflex N600/6	740	1531	245	66,00	R1"	<b>1.549,32</b>
<b>8218500</b>	4036705110191	Reflex N800/6	740	1996	245	96,00	R1"	<b>1.862,05</b>
<b>8218600</b>	4036705110207	Reflex N1000/6 *	740	2413	245	118,00	R1"	<b>2.413,74</b>

## REFLEX S, RAZTEZNE POSODE ZA SOLARNE SISTEME 10 bar - 120°C

Koda	EAN	Naziv	Premer (mm)	Višina (mm)	Viš. priklj. (mm)	Teža (kg)	Priključek	Cena
<b>8707700</b>	4036705109973	Reflex S2/10 *	132	260		0,98	G3/4"	<b>35,29</b>
<b>8703900</b>	4036705109850	Reflex S8/10	206	332		1,80	G3/4"	<b>65,41</b>
<b>8704000</b>	4036705109874	Reflex S12/10	280	300		2,16	G3/4"	<b>73,03</b>
<b>8704100</b>	4036705040993	Reflex S18/10	280	409		2,95	G3/4"	<b>88,40</b>
<b>8704200</b>	4036705041006	Reflex S25/10	280	518		3,68	G3/4"	<b>94,27</b>
<b>8706200</b>	4036705057731	Reflex S33/10	354	455		4,80	G3/4"	<b>142,02</b>
<b>8209500</b>	4036705037115	Reflex S50/10	415	469	158	8,06	R3/4"	<b>242,36</b>
<b>8210300</b>	4036705110382	Reflex S80/10 *	486	562	166	12,10	R1"	<b>261,45</b>
<b>8210500</b>	4036705110399	Reflex S100/10 *	486	667	165	12,90	R1"	<b>324,60</b>
<b>8211500</b>	4036705110405	Reflex S140/10 *	486	886	172	19,05	R1"	<b>841,20</b>
<b>8213400</b>	4036705110412	Reflex S200/10 *	640	758	205	27,50	R1"	<b>887,42</b>
<b>8214400</b>	4036705110429	Reflex S250/10 *	640	888	205	32,40	R1"	<b>1.032,32</b>
<b>8215400</b>	4036705110436	Reflex S300/10 *	640	1092	235	47,00	R1"	<b>1.138,05</b>
<b>8219000</b>	4036705110443	Reflex S400/10 *	746	1102	245	61,00	R1"	<b>1.619,75</b>
<b>8219100</b>	4036705110450	Reflex S500/10 *	746	1321	245	72,00	R1"	<b>1.740,35</b>

### TEHNIČNE LASTNOSTI REFLEX N

#### 5-letna garancija za Reflex N raztezne posode

Za zaprte ogrevalne in hladilne sisteme. Z navojnim priključkom. Nad 35 litrov stoječa posoda, velikost pod N80 stenska montaža. Obratovalna temperatura: 70°C. Dovoljen delovni tlak 4bar (8-35 l); 6bar (50-140 l). Primerno za dodajnje protizmrazovalne tekočine koncentracije 25 - 50%.

Odobreno po Direktivi o tlačni opremi (2014/68/EU). Zaščiteno z vzdržljivim epoxy premazom. Tovarniško preizkušena komora. Temperatura ogrete tekočine: 120°C.



\*Po naročilu

## REFLEX C, PLOŠČATE RAZTEZNE POSODE 3bar - 120°C (za več kot 50% protizmzovalne tekočine)



Stenske konzole vključene v ceno

Koda	EAN	Naziv	Debelina (mm)	Višina (mm)	Viš. priklj. (mm)	Teža (kg)	Premer (mm)	Priključek	Cena
<b>8280000</b>	4036705110245	Reflex C8/3 *	176	296	52	2,71	280	G1/2"	<b>110,57</b>
<b>8280100</b>	4036705110252	Reflex C12/3	182	370	64	3,60	354	G1/2"	<b>116,05</b>
<b>8280200</b>	4036705110269	Reflex C18/3	236	370	76	4,10	356	G3/4"	<b>126,62</b>
<b>8280300</b>	4036705110283	Reflex C25/3	253	427	93	5,10	409	G3/4"	<b>144,90</b>
<b>8280400</b>	4036705110290	Reflex C35/3	256	465	97	6,55	480	G3/4"	<b>169,05</b>
<b>8280500</b>	4036705110306	Reflex C50/3 *	332	465	125	8,00	480	G3/4"	<b>225,18</b>
<b>8280600</b>	4036705110313	Reflex C80/3 *	338	621	135	15,70	634	G3/4"	<b>317,21</b>

## REFLEX G, RAZTEZNE POSODE Z MEMBRANO 6bar - 120°C



Koda	EAN	Naziv	Premer (mm)	Višina (mm)	Viš. priklj. (mm)	Teža (kg)	Priključek	Cena
<b>8519000</b>	4036705111129	Reflex G100/6 *	480	850	145	19,20	G1"	<b>1.165,72</b>
<b>8519100</b>	4036705111136	Reflex G200/6 *	634	967	144	36,50	G1 1/4"	<b>1.417,66</b>
<b>8519200</b>	4036705111143	Reflex G300/6 *	634	1267	144	41,60	G1 1/4"	<b>1.750,54</b>
<b>8521605</b>	4036705111204	Reflex G400/6 *	740	1276	146	43,00	G1"	<b>2.417,60</b>
<b>8521705</b>	4036705111235	Reflex G500/6 *	740	1494	146	51,00	G1"	<b>2.822,27</b>
<b>8522605</b>	4036705111297	Reflex G600/6 *	740	1739	146	66,00	G1"	<b>3.126,43</b>
<b>8546605</b>	4036705111532	Reflex G1000/6 *	740	2593	146	150,00	G1"	<b>4.926,58</b>
<b>8527005</b>	4036705110801	Reflex G2000/6 *	1200	2451	291	300,00	DN65/PN16	<b>18.845,28</b>

## REFLEX G, RAZTEZNE POSODE Z MEMBRANO 10bar - 120°C



Koda	EAN	Naziv	Premer (mm)	Višina (mm)	Viš. priklj. (mm)	Teža (kg)	Priključek	Cena
<b>8518000</b>	4036705110993	Reflex G100/10 *	480	850	146	19,2	G1"	<b>1.468,58</b>
<b>8518100</b>	4036705111020	Reflex G200/10 *	634	966	144	33,4	G1 1/4"	<b>2.059,92</b>
<b>8518200</b>	4036705111051	Reflex G300/10 *	634	1267	144	34,6	G1 1/4"	<b>2.737,42</b>
<b>8521005</b>	4036705111167	Reflex G400/10 *	740	1275	133	52	G1 1/4"	<b>3.918,81</b>
<b>8521006</b>	4036705111174	Reflex G500/10 *	740	1494	133	60	G1 1/4"	<b>4.584,56</b>

## REFLEX V, VMESNA RAZTEZNA POSODA 10bar - 110°C

Koda	EAN	Naziv	Premer (mm)	Višina (mm)	Viš. priklj. (mm)	Teža (kg)	Priključek	Cena
<b>8303100</b>	4036705181092	Reflex V6/10 *	206	244	319	4	R 3/4"	<b>129,86</b>
<b>8303400</b>	4036705181122	Reflex V40/10 *	409	562	113	9,75	R1"	<b>129,86</b>
<b>8303600</b>	4036705181146	Reflex V200/10 *	634	901	142	35,25	DN40/PN16	<b>413,56</b>

## REFIX HW, RAZTEZNE POSODE ZA HIDROFOR 10bar - 70°C

Koda	EAN	Naziv	Dolžina / dolžina / d (mm)	Premer (mm)	Višina (mm)	Podstavek (mm)	Teža (kg)	Priključek	Cena
<b>7200310</b>	4036705106910	Refix HW 25/10	517,7 / 491 / 458	280	301	270	5,05	G 3/4"	<b>66,92</b>
<b>7200320</b>	4036705102288	Refix HW 50/10	503 / 476 / 440	409	432	350	9,00	G 1"	<b>182,15</b>
<b>7200340</b>	4036705102301	Refix HW 80/10	593 / 564 / 523	480	504	350	12,50	G 1"	<b>423,48</b>
<b>7200350*</b>	4036705102318	Refix HW 100/10	706 / 667 / 640	480	504	350	14,06	G 1"	<b>473,53</b>

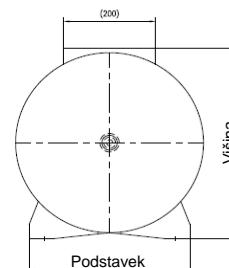
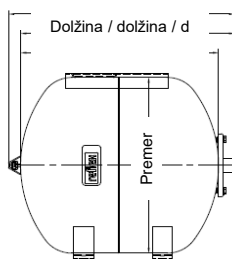

\*Po naročilu



## REFIX DD, PRETOČNE RAZTEZNE POSODE ZA SANITARNO VODO 10bar – 70°C

Koda	EAN	Naziv	Premer (mm)	Višina (mm)	Teža (kg)	Priključek	Cena
<b>7381500</b>	4036705082658	Refix DD2/10 *	132	269	0,98	G3/4"	<b>118,27</b>
<b>7308000</b>	4036705001406	Refix DD8/10	206	345	1,80	G3/4"	<b>122,97</b>
<b>7308200</b>	4036705001420	Refix DD12/10	280	318	2,20	G3/4"	<b>131,58</b>
<b>7308300</b>	4036705001437	Refix DD18/10	280	418	3,04	G3/4"	<b>149,21</b>
<b>7308400</b>	4036705001444	Refix DD25/10	280	528	3,80	G3/4"	<b>181,32</b>
<b>7380700</b>	4036705057779	Refix DD33/10	354	468	5,06	G3/4"	<b>286,67</b>



## REFIX DT, PRETOČNE RAZTEZNE POSODE ZA SANITARNO VODO 10bar - 70°C + flowjet

Koda	EAN	Naziv	Premer (mm)	Višina (mm)	Viš. priklj. (mm)	Teža (kg)	Priključek-ventil (flowjet)	Cena
<b>7309000</b>	4036705001475	Refix DT60/10	409	766	80	15,00	Rp 1¼"	<b>1.506,17</b>
<b>7309100</b>	4036705001482	Refix DT80/10	480	750	17	17,00	Rp 1¼"	<b>1.558,65</b>
<b>7309200</b>	4036705001499	Refix DT100/10	480	834	19	19,20	Rp 1¼"	<b>1.880,56</b>
<b>7309300</b>	4036705001505	Refix DT200/10	634	973	80	37,00	Rp 1¼"	<b>2.059,14</b>
<b>7309400</b>	4036705001512	Refix DT300/10	634	1273	80	51,00	Rp 1¼"	<b>2.185,24</b>
<b>7319305</b>	4036705079382	Refix DT400/10	740	1245	69	74,00	Rp 1¼"	<b>2.762,48</b>
<b>7309500</b>	4036705001529	Refix DT500/10	740	1475	69	72,00	Rp 1¼"	<b>3.190,14</b>



## REFIX DT, PRETOČNE RAZTEZNE POSODE ZA SANITARNO VODO 10bar - 70°C - 2 priključka

Koda	EAN	Naziv	Premer (mm)	Višina (mm)	Viš. priklj. (mm)	Teža (kg)	Priključek	Cena
<b>7365400</b>	4036705043512	Refix DT100/10 *	480	834	97	26,8	DN50/PN16	<b>1.911,89</b>
<b>7365100</b>	4036705039492	Refix DT200/10 *	634	973	105	53,00	DN50/PN16	<b>2.090,47</b>
<b>7365200</b>	4036705039508	Refix DT300/10 *	634	1273	105	59	DN50/PN16	<b>2.217,35</b>
<b>7365500</b>	4036705078217	Refix DT400/10 *	740	1245	80	80	DN50/PN16	<b>2.790,69</b>
<b>7365300</b>	4036705039515	Refix DT500/10 *	740	1475	90	88	DN50/PN16	<b>3.219,12</b>
<b>7365600</b>	4036705078224	Refix DT600/10 *	740	1859	233	164	DN50/PN16	<b>4.838,86</b>
<b>7365700</b>	4036705078231	Refix DT800/10 *	740	2324	233	204	DN50/PN16	<b>5.767,78</b>
<b>7365800</b>	4036705078248	Refix DT1000/10 *	740	2804	233	260	DN50/PN16	<b>6.805,57</b>
<b>7335705</b>	4036705079207	Refix DT80/10 *	480	750	107	24,70	DN65/PN16	<b>1.639,33</b>
<b>7336505</b>	4036705079399	Refix DT400/10 *	740	1245	105	81,00	DN65/PN16	<b>2.843,94</b>
<b>7320105</b>	4036705066887	Refix DT1000/10 *	1000	2001	160	386,20	DN65/PN16	<b>7.650,69</b>
<b>7320305</b>	4036705065798	Refix DT1500/10 *	1200	2001	158	502,40	DN65/PN16	<b>9.044,86</b>
<b>7365406</b>	4036705079245	Refix DT100/10 *	480	834	114	26,8	DN80/PN16	<b>2.001,96</b>
<b>7365106</b>	4036705079290	Refix DT200/10 *	634	973	120	57,00	DN80/PN16	<b>2.090,47</b>
<b>7337205</b>	4036705079603	Refix DT1000/10 *	1000	2001	160	386,20	DN80/PN16	<b>6.912,87</b>



## REFIX DT, PRETOČNE RAZTEZNE POSODE ZA SANITARNO VODO 16bar - 70°C - 2 priključka

Koda	EAN	Naziv	Premer (mm)	Višina (mm)	Viš. priklj. (mm)	Teža (kg)	Priključek	Cena
<b>7370200</b>	4036705078279	Refix DT200/16 *	634	973	105	61	DN50/PN16	<b>2.395,93</b>
<b>7370300</b>	4036705078286	Refix DT300/16 *	634	1273	105	70	DN50/PN16	<b>2.540,83</b>
<b>7370600</b>	4036705078316	Refix DT600/16 *	740	1859	235	174	DN50/PN16	<b>5.209,33</b>
<b>7370700</b>	4036705078323	Refix DT800/16 *	740	2324	235	224	DN50/PN16	<b>6.303,52</b>
<b>7370800</b>	4036705078330	Refix DT1000/16 *	740	2804	235	275	DN50/PN16	<b>7.541,82</b>
<b>7370102</b>	4036705080265	Refix DT100/16 *	480	834	114	38	DN80/PN16	<b>2.296,45</b>
<b>7370505</b>	4036705079467	Refix DT500/16 *	740	1615	235	140	DN80/PN16	<b>3.799,49</b>



\*Po naročilu

## REFIX DE, RAZTEZNE POSODE ZA SANITARNO VODO 10bar - 70°C

Koda	EAN	Naziv	Premer (mm)	Višina (mm)	Viš. priklj. (mm)	Teža (kg)	Priključek	Cena
<b>7200300</b>	4036705072475	Refix DE2/10	132	260		0,98	G3/4"	<b>55,61</b>
<b>7301000</b>	4036705000584	Refix DE8/10	206	332		1,80	G3/4"	<b>65,29</b>
<b>7302000</b>	4036705000737	Refix DE12/10	280	310		2,16	G3/4"	<b>71,21</b>
<b>7303000</b>	4036705000836	Refix DE18/10	280	407		3,27	G3/4"	<b>86,93</b>
<b>7304000</b>	4036705000935	Refix DE25/10	280	518		3,75	G3/4"	<b>94,27</b>
<b>7303900</b>	4036705057793	Refix DE33/10	354	457		4,95	G3/4"	<b>137,93</b>
<b>7306400</b>	4036705001208	Refix DE60/10	409	734	161	10,50	G1"	<b>317,26</b>
<b>7306500</b>	4036705001215	Refix DE80/10	480	737	143	12,80	G1"	<b>358,62</b>
<b>7306600</b>	4036705001222	Refix DE100/10	480	852	143	14,80	G1"	<b>464,32</b>
<b>7306700</b>	4036705001239	Refix DE200/10	634	967	150	34,80	G1 1/4"	<b>763,21</b>
<b>7306800</b>	4036705001246	Refix DE300/10	634	1267	150	41,60	G1 1/4"	<b>855,10</b>
<b>7306900</b>	4036705001253	Refix DE500/10	740	1475	133	74,00	G1 1/4"	<b>1.360,81</b>
<b>7311605</b>	4036705066764	Refix DE1500/10	1200	1991	291	426,00	DN65/PN16	<b>10.436,93</b>
<b>7311805</b>	4036705066788	Refix DE3000/10	1500	2531	320	962,00	DN65/PN16	<b>22.817,34</b>

Z nezamenljivo membrano:

Koda	EAN	Naziv	Višina (mm)	Viš. priklj. (mm)	Premer (mm)	Priključek	Cena
<b>7200400</b>	4036705074110	Refix DC25/10 junior	510		289	G1"	<b>68,55</b>
<b>7309600</b>	4036705037245	Refix DC50/10 junior	588	115	418	G1"	<b>186,55</b>

## REFIX WD MINI, PRETOČNA RAZTEZNA POSODA ZA SANITARNO VODO, 10bar – 70°C

Koda	EAN	Naziv	Premer (mm)	Višina (mm)	Teža (kg)	Priključek	Cena
<b>7351000</b>	4036705005374	Refix WD mini (za pralne stroje, plinske kotli	83	111	0,30	G 1/2"	<b>94,69</b>

## SERVISNI VENTIL

Koda	EAN	Naziv	Cena
<b>8770</b>	8595222613357	Servisni ventil 3/4" za raztezne posode in kontrolo tlaka	<b>35,28</b>
<b>7613000</b>	4036705008108	Servisni ventil 3/4" za raztezne posode in kontrolo tlaka	<b>77,55</b>
<b>7613100</b>	4036705008115	Servisni ventil 1" za raztezne posode in kontrolo tlaka	<b>130,16</b>
<b>12295</b>	8595222633119	Servisni ventil 1" za raztezne posode in kontrolo tlaka	<b>37,38</b>
<b>9116799</b>	4036705066566	Servisni ventil 3/4" M/F za pretočne raztezne posode in kontrolo tlaka	<b>51,59</b>

## DIGITALNI MERILNIK TLAKA

Koda	EAN	Naziv	Cena
<b>9119198</b>	4036705083143	Elektronski merilnik tlaka v raztezni posodi (max.9bar)	<b>50,91</b>

## KONZOLA ZA RAZTEZNO POSODO

Koda	EAN	Naziv	Cena
<b>KONEKS34</b>	3830016900769	Konzola za raztezno posodo 3/4"	<b>11,15</b>
<b>7610</b>	3830016907614	Konzola za raztezno posodo 1"	<b>13,481</b>

## PRITRDILNA OBJEMKA

Koda	EAN	Naziv	Cena
<b>7611000</b>	4036705008085	Objemka pritrdilna za raztezno posodo	<b>16,97</b>





## OBTOČNA ČRPALKA

Koda	Naziv	Cena
<b>AVANSA254180</b>	AVANSA OBT.ČRPALKA 25-40-180	<b>96,75</b>
<b>AVANSA256180</b>	AVANSA OBT.ČRPALKA 25-60-180	<b>105,16</b>
<b>AVANSA258180</b>	AVANSA OBT.ČRPALKA 25-80-180	<b>192,76</b>
<b>AVANSA326180</b>	AVANSA OBT.ČRPALKA 32-60-180	<b>108,34</b>
<b>AVANSA328180</b>	AVANSA OBT.ČRPALKA 32-80-180	<b>205,20</b>

## TEHNIČNE LASTNOSTI

	Avansa 25/4/180	Avansa 25/6/180	Avansa 25/8/180	Avansa 32/6/180	Avansa 32/8/180
Skupna dolžina	180mm	180 mm	130 mm	180 mm	180 mm
Vhod	38/53/72 W	93/67/46 W	182/170/145 W	93/67/46 W	150/210/1250 W
Dostava (m)	4	6	8	6	8
Dimenzije (cm)	13,5x19,5x14,5	13,5x19,5x14,5	19x16x15	19,5x14,5x13,5	19,5x14,5x15,5
Teža (kg)	2,7	2,8	4,5	3	3
DN dovod (mm)	25	25	25	32	32
DN izpust (mm)	25	25	25	32	32
Največji pretok (l/min)	48	55	115	55	160
Navoj povezave	6/4"	6/4"	6/4"	2"	2"

Največji delovni tlak: 10 bar

Temperatura tekočine: od -10 do +110°C

Zaščita: IP44

Razred izolacije: FH

Material: lito železo / plastika

Napetost (V): 230



## ELEKTRONSKA OBTOČNA ČRPALKA

Koda	Naziv	Cena
<b>AVANSA254E180</b>	AVANSA OBT.ČRPALKA 25-40-180E	<b>183,73</b>
<b>AVANSA256E180</b>	AVANSA OBT.ČRPALKA 25-60-180E	<b>185,68</b>
<b>AVANSA326E180</b>	AVANSA OBT.ČRPALKA 32-60-180E	<b>188,12</b>

## TEHNIČNE LASTNOSTI

	Avansa 25/4/180E	Avansa 25/6/180E	Avansa 32/8/180E
Skupna dolžina	180 mm	180 mm	180 mm
Vhod	35 W	45 W	150/210/1250 W
Dostava (m)	4	6	6
Dimenzije (cm)	19,5x14,5x15,5	19,5x14,5x15,5	19,5x14,5x15,5
Teža (kg)	2,5	2,7	3,3
DN dovod (mm)	25	25	2"
DN izpust (mm)	25	25	2"
Največji pretok (l/min)	48	58	160
Navoj povezave	1"	6/4"	6/4"

Največji delovni tlak: 10 bar

Temperatura tekočine: -10 až +110°C

Zaščita: IP44

Razred izolacije: FH

Material: lito železo / plastika

Napetost (V): 230

Frekvenca: 50/60Hz

## SET ZA TALNO OGREVANJE Z NASTAVLJIVO TEMPERATURO 20-45°C

Koda	DN	Cena
<b>104687G-F3-P6</b>	1"	<b>342,21</b>



## SET ZA TALNO OGREVANJE S 3-POTNIM MEŠALNIM VENILOM

Koda	DN	Cena
<b>104686-M3-C6</b>	1"	<b>264,91</b>



## MOTORNI POGON TRITOČKOVNI

Koda	Napetost	Cena
<b>TRM20</b>	230V	<b>89,91</b>



## 3-POTNI MEŠALNI VENTIL M za talno ogrevanje

Koda	DN	Cena
<b>041036</b>	1"M	<b>48,98</b>



## 3-POTNI MEŠALNI VENTIL F

Koda	DN	Cena
<b>041055-10</b>	1"F	<b>49,39</b>
<b>051055-16</b>	1 ¼"F	<b>57,64</b>



## KROGELNI VENTIL S TERMOMETROM

Koda	navoj/matica/holandec	Cena
<b>04550STER-(R/B)</b>	1"/1¼"	<b>25,10</b>
<b>05550STER-(R/B)</b>	1 ¼"/1 ¼"	<b>28,11</b>
<b>0555AMS-TER-(B/R)</b>	1 ¼"/2"	<b>31,47</b>



## 4-POTNI MEŠALNI VENTIL F

Koda	DN	Cena
<b>041065-10</b>	1"F	<b>55,83</b>
<b>051065-16</b>	1 ¼"F	<b>63,61</b>



## KROGELNI VENTIL S TERMOMETROM Z NEPOVRATNO LOPUTO

Koda	DN	Cena
<b>04550S/2TER-R</b>	1"	<b>27,98</b>
<b>05550S/2TER-R</b>	1 ¼"	<b>31,54</b>



## SET MATICE IN TESNILA

Koda	DN	Cena
<b>AYHU26SET</b>	1 ¼"	<b>2,71</b>
<b>AYHT07SET</b>	2"	<b>6,11</b>



## KROGELNI VENTIL S PODALJŠANO ROČICO

Koda	DN	Cena
<b>04550SISO</b>	1"	<b>20,51</b>
<b>05550SISO</b>	1 ¼"	<b>23,74</b>



## KROGELNI VENTIL S HOLANDCEM ZA VODOMER

Koda	DN	Cena
<b>0328</b>	1/2" x 3/4"	<b>10,02</b>



## KROGELNI VENTIL S HOLANDCEM ZA VODOMER

Koda	DN	Cena
<b>0319</b>	3/4" x 1"	<b>14,90</b>



## SERVISNI VENTIL ZA RAZTEZNO POSODO



Koda	DN	Cena
<b>8770</b>	3/4" M/F	<b>15,81</b>
EAN: 8595222613357		
<b>12295</b>	1" M/F	<b>20,97</b>
EAN: 8595222633119		

## TERMIČNO VAROVALO za kotel s hladilnim krogom



Koda	Naziv	Cena
<b>14478</b>	<b>BVTS 4m / 95°C 3/4"F</b>	<b>113,09</b>
EAN: 8595222647918 tulka 140mm		

Termično varovalo proti pregretju kotla s hladilnim krogom fiksna kapilara 4m

## REGULATOR VLEKA RT4



Koda	Naziv	Cena
<b>13878</b>	<b>RT4</b>	<b>40,85</b>
EAN: 8595222643910		

Regulator vleka za kotle na trda goriva

## TERMIČNO VAROVALO za kotel s hladilnim krogom



Koda	Naziv	Cena
<b>14477</b>	<b>BVTS 1,3m</b>	<b>76,86</b>
EAN: 8595222647901 3/4"F		

95°C  
tulka 140mm

Termično varovalo proti pregretju kotla s hladilnim krogom fiksna kapilara 1,3m

## TERMIČNO VAROVALO DBV2



Koda	Naziv	Cena
<b>16627</b>	<b>DBV2</b> v izolaciji	<b>131,76</b>
EAN: 8595222663925 3/4"		
97°C		
Teža 0,8 kg		

Termično varovalo proti pregretju kotla brez hladilnega kroga

## TERMIČNO VAROVALO s hladilnim krogom JBV-1P



Koda	Naziv	Cena
<b>8877</b>	<b>JBV-1P</b> 3/4" / '97°C	<b>58,41</b>
EAN: 8595222602054		

Termično varovalo proti pregretju kotla s hladilnim krogom

## PLOŠČATI IZMENJEVALEC DV193-20E



Koda	Cena
<b>9548</b> 20kW 1000 L/h	<b>144,94</b>
Priključek: 4 x 3/4" M	
Tlak: 29,4bar	
Izoliran, 20 inox plošč	
Max.temp.delovanja: 150°C	

Za ogrevanje vode v zalogovniku ali bazenu - kotli, sončno ogrevanje, toplotna črpalka

## PLOŠČATI IZMENJEVALEC DV193-30E



Koda	Cena
<b>9549</b> 30kW 1000 L/h	<b>183,37</b>
Priključek: 4 x 3/4" M	
Tlak: 29,4bar	
Izoliran, 30 inox plošč	
Max.temp.delovanja: 150°C	

Za ogrevanje vode v zalogovniku ali bazenu - kotli, sončno ogrevanje, toplotna črpalka

## POTOPNA TULKA



Koda	Naziv	Cena
<b>14880</b>	<b>za 1 tipalo</b>	<b>4,68</b>
1/2" - 7 x 9 x 100		
<b>14881</b>	<b>za 1 tipalo</b>	<b>8,55</b>
1/2" - 7 x 9 x 200		
<b>15744</b>	<b>za 3 tipala</b>	<b>5,06</b>
1/2" - 13,5 x 16 x 100		
<b>15743</b>	<b>za 3 tipala</b>	<b>9,62</b>
1/2" - 13,5 x 16 x 230		
<b>14882</b>	<b>za 4 tipala</b>	<b>5,38</b>
1/2" - 15 x 17 x 120		

## TEMPERATURNI MEŠALNI VENTIL TSV3B



Koda	Temp./dim.	Cena
<b>11281</b>	DN25 55°C	<b>68,73</b>
EAN: 8595222624070 3 x 1"F		

## TEMPERATURNI MEŠALNI VENTIL TSV5B



Koda	Temp./dim.	Cena
<b>11807</b>	DN32 55°C	<b>82,24</b>
EAN: 8595222629471 3 x 5/4"F		
<b>11808</b>	DN32 65°C	<b>82,24</b>
3 x 5/4"F		

## GRELEC za bojler / zalogovnik



Koda	Naziv	Cena
<b>8939</b>	<b>Grelec 7,5kW</b>	<b>135,05</b>

## TERMOELEMENT za temperat. meš. ventil TSV3B, 5B



Koda	Naziv	Cena
<b>12102</b>	Termoelement za temperaturni mešalni ventil TSV3B, 5B, 45°C	<b>39,97</b>
<b>12101</b>	Termoelement za temperaturni mešalni ventil TSV3B, 5B, 55°C	<b>39,97</b>

## ROČNA POLNILNA NAPRAVA z Ilijakom 600ml



Koda		Cena
<b>15054</b>	Za solarne sisteme	<b>147,13</b>

## ROČNA POLNILNA NAPRAVA



Koda		Cena
<b>15111</b>	Za solarne sisteme	<b>84,67</b>

## MEŠALNI VENTIL TSV-TV-MT52HC



Koda	*Odprodaja	Temp./dim.	Cena
<b>7079</b>		5/4" M, DN32 20-70°C	<b>103,58</b>

## MEŠALNI VENTIL TSV1

Koda	*Odprodaja	Temp./dim.	Cena
<b>8121</b>		1" 45°C	<b>46,24</b>

## ELEKTROMOTORNI VENTIL LK525 5/4" M 230V



Koda	*Odprodaja	Temp./dim.	Cena
<b>12875</b>		DN32 90°C	<b>84,18</b>

z aktuatorjem in kablom

<b>11278</b>	Adapter za pogone LK52	<b>7,20</b>
--------------	------------------------	-------------



## TEMPERATURNI MEŠALNI VENTIL TSV6B



Koda	*Odprodaja	Temp./dim.	Cena
<b>12975</b>		DN40 55°C	<b>54,79</b>

3 x 6/4" F

## ROTODIVERT



Koda	*Odprodaja	Temp./dim.	Cena
<b>11285</b>		DN32 80°C	<b>74,30</b>

Z aktuatorjem in kablom

## TEMPERATURNI MEŠALNI VENTIL TSV8B



Koda	*Odprodaja	Temp./dim.	Cena
<b>12978</b>		DN50 55°C	<b>71,98</b>

3 x 2" F

## HOLANDEC MS za TSV



Koda	*Odprodaja	Cena
<b>6549</b>	1"	<b>3,72</b>

<b>6552</b>	2"	<b>12,08</b>
-------------	----	--------------

<b>65528</b>	6/4"	<b>12,08</b>
--------------	------	--------------

<b>12700</b>	Cu28 x 5/4" (set 3)	<b>8,91</b>
--------------	---------------------	-------------

## TEMPERATURNI MEŠALNI VENTIL TSV5



Koda	*Odprodaja	Temp./dim.	Cena
<b>11804</b>		DN32 65°C	<b>42,58</b>

3 x 5/4" F

## SOLARNI SKLOP S1 RS25/6



Koda	*Odprodaja	Cena
<b>9047</b>	2-12L/min 3/4"	<b>193,98</b>

## TEMPERATURNI MEŠALNI VENTIL TSV6



Koda	*Odprodaja	Temp./dim.	Cena
<b>11821</b>		DN40 65°C	<b>54,41</b>

3 x 6/4" F

## TIPALO KOLEKTORJA TSK 10 D1



Koda	*Odprodaja	Cena
<b>1818</b>		<b>11,96</b>

## VARNOSTNI VENTIL SOLAR



Koda	*Odprodaja	DN	Cena
<b>02690-03</b>		1/2" x 3/4"	<b>6,83</b>

## SOLARNI REGULATOR UR1 A-DT z dvema tipaloma



Koda	*Odprodaja	Cena
<b>14159</b>		<b>172,02</b>

## GRELEC za bojler / zalogovnik



Koda	*Odprodaja	Cena
<b>8930</b>	Grelec 2kW 6/4" 3F	<b>169,58</b>



## SERIJA SMART HOME

Koda	*Po naročilu	Naziv	EAN: 5060103697670	Cena
------	--------------	-------	--------------------	------

<b>SQ610</b>	*	Podometni žič./brežič. sobni termostat Quantum, bel, deb.11mm		<b>158,60</b>
--------------	---	---	--	---------------

Podometni večfunkcijski termostat s senzorjem vlage za: -brežično krmiljenje naprav iz serije SMART HOME preko aplikacije in internetnega prehoda UGE600, -žično krmiljenje naprav (žični priključni modul, kotel) -offline (brez povezave z internetom) preko enote CO10RF Senzor vlage, univerzalni vhod (senzor temperature, senzor zasedenosti, onetouch), zaščita ventilov, možnost zaklepa PIN in omejitve temperature, funkcije časovni načrt in warm floor, poveča pokritost Zig-bee omrežja. Napajanje 230V AC 50Hz, temperaturna natančnost 0,5-0,1°C; delovna temperatura 0-45°C, zaščita IP30, dimenzije 86x86x28mm, nadometna debelina 10mm.

Koda	Naziv	EAN: 5060103697687	Cena
------	-------	--------------------	------

<b>SQ610RF</b>		Nadometni brezžični sobni termostat Quantum, bel, deb.11mm	<b>158,60</b>
----------------	--	--	---------------

Podometni večfunkcijski termostat s senzorjem vlage in vgrajenim akumulatorjem za brezžično krmiljenje Senzor vlage, univerzalni vhod (senzor temperature, senzor zasedenosti, onetouch), zaščita ventilov, možnost zaklepa PIN in omejitve temperature, funkcije časovni načrt in warm floor, poveča pokritost Zig-bee omrežja. Napajanje 230V AC 50Hz, temperaturna natančnost 0,5-0,1°C; delovna temp. 0-45°C, zaščita IP30, dim. 86x86x28mm, nadometna debelina 10mm.

Koda	*Po naročilu	Naziv	EAN: 5060103692330 / 5060103692323	Cena
------	--------------	-------	------------------------------------	------

<b>VS10WRF</b>		Podometni brezžični sobni termostat, bel		<b>134,44</b>
----------------	--	--	--	---------------

<b>VS10BRF</b>	*	Podometni brezžični sobni termostat, črn		<b>134,44</b>
----------------	---	--	--	---------------

Omogoča krmiljenje priključnega modula KL10RF/KL08RF (ogrevanje/hlajenje), termostatske glave TRV, modula RX10RF in drugih Smart Home naprav preko aplikacije in internetnega pregoda UGE600, ali brez povezave z internetom preko enote CO10RF. Časovni načrt: 3 nastavljive temperature, ročni, počitniški način, časovnik za toplo vodo. Vhod za dodatni senzor temp. (tal, zraka) ali senzor zasedenosti. Napajanje 230V AC 50Hz, temperaturno območje 5 - 35°C, temperaturna natančnost 0,5°C, temp. diferenca ±0,25°C ±0,5°C, komunikacija brezžična ZigBee 2.4 Ghz, dim.: 86x86x42mm. Podometna doza ø60. 5-letna garancija.

Koda	*Po naročilu	Naziv	EAN: 5060103692354 / 5060103692347	Cena
------	--------------	-------	------------------------------------	------

<b>VS20WRF</b>		Brezžični sobni termostat, baterijsko napajanje, bel		<b>134,44</b>
----------------	--	--	--	---------------

<b>VS20BRF</b>	*	Brezžični sobni termostat, baterijsko napajanje, črn		<b>134,44</b>
----------------	---	--	--	---------------

Omogoča krmiljenje priključnega modula KL10RF/KL08RF (ogrevanje/hlajenje), termostatske glave TRV, modula RX10RF in drugih Smart Home naprav preko aplikacije in internetnega pregoda UGE600, ali brez povezave z internetom preko enote CO10RF. Časovni načrt: 3 nastavljive temperature, ročni, počitniški način, časovnik za toplo vodo. Vhod za dodatni senzor temperature (tal, zraka) ali senzor zasedenosti. Napajanje 4 x AAA baterije, temperaturno območje 5 - 35°C, temp. natančnost 0,5°C, histereza ±0,25°C ±0,5°C, komunikacija brezžična ZigBee 2.4 Ghz, dim.: 86x86x29mm. 5-letna garancija.

Koda	Naziv	EAN: 5060103692682	Cena
------	-------	--------------------	------

<b>KL08RF</b>		Priključni brezžični modul, 8 con, talno ogrevanje	<b>278,04</b>
---------------	--	--	---------------

Modul deluje s termostati SmartHome preko aplikacije in internetnega pregoda UGE600, ali offline preko enote CO10RF. Brezžična komunikacija, Zigbee 2,4GHz. Za 8 kontrolnih območij, 24 izhodov za povezavo pogonov (3 pogoni na cono). Vhodi: sprememba načina ogrevanje/hlajenje, senzor rosišča. Krmilni izhodi za črpalko in kotel. Združljivo s termostati VS10RF/VS20RF, termostati HTR-RF(20), HTRS-RF(30), HTRP-RF(50), temp. senzorjem TS600, sistemskim oddajnikom RX10RF. Dim.: 353x85x67mm. Opcija: dodatna antena za povečanje RF območja. Napajanje 230V AC 50Hz. Izhodi za pogone: 230V. Garancija 5 let.

Koda	*Po naročilu	Naziv	EAN: 5060103692675	Cena
------	--------------	-------	--------------------	------

<b>KL04RF</b>	*	Dodatni priključni brezžični modul za KL08RF, 4 cone		<b>71,98</b>
---------------	---	--	--	--------------

Modul za nadgradnjo KL08RF za dodatna 4 kontrolna območja, preklap ogrevanje/hlajenje. Napajanje 230V. Izhod: 230V. Dimenzije 170 x 85 x 67mm. Garancija 5 let.

Koda	Naziv	EAN: 5060103694457	Cena
------	-------	--------------------	------

<b>TS600</b>		Brezžični sobni senzor s funkcijo termostata, baterijski	<b>65,88</b>
--------------	--	--	--------------

Brezžični nadometni senzor / programski termostat je preko aplikacije združljiv z napravami iT600RF sistema: KL10RF/KL08RF- brezžični priključni modul za talno ogrevanje, TRV- digitalna termostatska glava, RX10RF- sprejemnik za kotel (brezžični krmilni modul), SR600-programabilen rele, SPE600-programabilen električni priključek. Deluje samo v povezavi z univerzalnim prehodom UGE600. Napajanje: 2xAA bateriji, natančnost prikaza temperature (v aplikaciji) 0,5°C, histereza ±0,25°C ±0,5°C. Brezžični signal: ZigBee 2.4 GHz, temperaturno območje: 5-35°C. Dimenzije 51x85x26mm.

Koda	Naziv	EAN: 5060103692279	Cena
------	-------	--------------------	------

<b>RX10RF</b>		Brezžični sprejemnik (samo ena enota na posamezni sistem)	<b>98,82</b>
---------------	--	---	--------------

Krmilni modul je izvršilni element sistema SmartHome, ki se vključuje, ko prejme signal s termostata. Je alternativna žični povezavi med kotlom in KL08RF priključnim modulom. V sistemu s TRV10RFM glavami je opcijski element za zagon vira toplote. Lahko deluje kot sprejemnik za en termostat (tip RX2) ali skupine termostatov (tip RX1). Napajanje 230V AC 50Hz, maksimalna obremenitev 16 (5)A, izhodni signal rele NO/COM, brezžični komunikator ZigBee 2.4GHz. Dimenzije: 145x100x35mm. Garancija 5 let.

Koda	Naziv	EAN: 5060103693269 / 5060103693474	Cena
------	-------	------------------------------------	------

<b>TP10</b>		Zaščita za termostatsko glavo TRV10RAM (javni prostori)	<b>15,25</b>
-------------	--	---	--------------

<b>TP28-30</b>		Zaščita za termostatsko glavo TRV10RFM / TRV28RFM (javni prostori)	<b>15,25</b>
----------------	--	--	--------------

Zaščita pred poseganjem in krajo. V setu: A objemka M30x1,5, B objemka M28x1,5, vijak, imbus ključ.



## SERIJA SMART HOME

Koda	*Po naročilu Naziv	EAN: 5060103692903	Cena
------	--------------------	--------------------	------

<b>TRV10RAM *</b>	TRV brezžična termostatska radiatorska glava (Danfoss RA)		<b>100,65</b>
-------------------	---	--	---------------

Za nadzor radiatorskega ogrevanja, v povezavi z brezžičnim termostatom preko enote CO10RF ali internetnega prehoda UGE600 (ni priloženo). možnost krmiljenja do 6 glav z enim termostatom. Združljivo s termostati VS10RF/VS20RF, HTRS-RF(30), HTRP-RF(50), TS600, priključnim žičnim modulom KL10RF, sprejemnikom RX10RF. Za Danfoss RA ventile. Napajanje 2 x AA baterije. Dimenzije: 52x85mm. Garancija 5 let.

Koda	Naziv	EAN: 5060103692743	Cena
------	-------	--------------------	------

<b>TRV10RFM</b>	TRV brezžična termostatska radiatorska glava (univerzalna)		<b>100,65</b>
-----------------	--	--	---------------

Za nadzor radiatorskega ogrevanja, v povezavi z brezžičnim termostatom preko enote CO10RF ali internetnega prehoda UGE600 (ni priloženo). možnost krmiljenja do 6 glav z enim termostatom. Združljivo s termostati VS10RF/VS20RF, HTRS-RF(30), HTR-RF(20), HTRP-RF(50), TS600, priključnim žičnim modulom KL10RF, sprejemnikom RX10RF. Za ventile Danfoss RA, TA Heimeier, Honeywell, Oventrop. Priključek M30 x 1,5. Napajanje 2 x AA baterije. Dimenzije: 52x85mm. Garancija 5 let.

## SERIJA SMART HOME (iT600RF)

Koda	Naziv	EAN: 5060103693252	Cena
------	-------	--------------------	------

<b>UGE600</b>	Univerzalni internetni prehod ZigBee		<b>187,15</b>
---------------	--------------------------------------	--	---------------

Omogoča koordinacijo naprav SmartHome s krmiljenjem preko telefona ali računalnika z uporabo aplikacije. Napajanje: 5V DC preko USB. ZigBee 2.4Ghz. Delovna temperatura 0-50°C. Omogoča povezavo do 100 oz. do 32 naprav, če so vse na baterijsko napajanje. Napajanje 5V DC, Port 1 x 10/100 LAN port, priložen LAN-kabel in napajalnik. Dim.: višina 55,5mm, ø90mm.

Koda	Naziv	EAN: 5060103693184	Cena
------	-------	--------------------	------

<b>SPE600</b>	Pametni priključek		<b>88,33</b>
---------------	--------------------	--	--------------

Nadzor prek pametnega telefona ali računalnika z uporabo aplikacije SALUS Smart Home, v povezavi z univerzalnim vhodom UGE600. Meri moč priključenih naprav, zaščita pred prekomerno obremenitvijo, programabilen urnik v aplikaciji SmartHome, deluje kot ponavljalnik za omrežje ZigBee, LED indikator, razširitev ZigBee signala. Maksimalna obremenitev 16A. Dim. 42x77x42mm.

Koda	Naziv	EAN: 5060103694167	Cena
------	-------	--------------------	------

<b>RE600</b>	Repetitor ZigBee - ojačevalec signala		<b>68,32</b>
--------------	---------------------------------------	--	--------------

Repetitor RE600 poveča obseg omrežja ZigBee, v primeru motenj med posameznimi napravami. Online: v povezavi z univerzalnim sprejemnikom UGE600 (naprodaj posebej) in aplikacijo SmartHome, offline s koordinatorjem CO10RF. Napajanje 230V AC 50Hz. Dim. 45x45x20mm.

Koda	Naziv	EAN: 5060103694143	Cena
------	-------	--------------------	------

<b>SR600</b>	Pametni rele (z S1/S2 komunikacijskima kontaktoma)		<b>60,63</b>
--------------	--	--	--------------

Daljinski rele za napetostne naprave (kotli, črpalke, ventili, pogoni, osvetlitev - 230V), za breznapetostne naprave (alarm, krmilniki vrat, senzor odpiranja), deluje kot ponavljalnik - poveča ZigBee območje, ali kot pametni vhod sistema, programabilen urnik v aplikaciji. Uporaba z UGE600 vhodom in Salus Smart Home aplikacijo. Napajanje 230V AC 50Hz, maksimalna obremenitev 16 (5)A, vhod in izhod S1, S2 izhodni signal rele NO/COM, brezžična komunikacija ZigBee 2.4GHz. Dimenzije: 45x45x20mm.

Koda	Naziv	EAN: 5060103697144	Cena
------	-------	--------------------	------

<b>RS600</b>	Krmilnik za rolete in osvetlitev		<b>64,66</b>
--------------	----------------------------------	--	--------------

Upravljanje s stenskim roletami, zavesami ali osvetlitvijo z maksimalno obremenitvijo 5 A. Možno namestiti v dozi ali ohišju SRS600. Deluje kot ponavljalnik, poveča ZigBee območje. Naprava je tovarniško pripravljena za krmiljenje pogonov 230 V AC, razširitev ZigBee signala. Napajanje 230V AC 50Hz, maksimalna obremenitev 5(2)A, vhod in izhod S1, S2: 230V AC 50Hz. Brezžična komunikacija ZigBee 2.4GHz. Dimenzije: 45x45x20mm.

Koda	Naziv	EAN: 5060103697731	Cena
------	-------	--------------------	------

<b>PS600</b>	Brezžično temperaturno tipalo		<b>72,47</b>
--------------	-------------------------------	--	--------------

Temperaturno tipalo PS600 omogoča krmiljenje izdelkov priključenih na pametne vtičnice SPE600 ali releje SR600, npr. črpalke, ventilov, pogonov. Veliko merilno območje tipala je zelo pomembno, ker zagotavlja široko področje uporabe za sisteme ogrevanja, hlajenja, nadzorovanja temperatur ali aktiviranja dogodkov/pravil OneTouch v okviru sistema. Za pravilno delovanje senzorja sta potrebna internetni prehod UGE600 in aplikacija SALUS Smart Home. Senzor za namestitev na cev 15-18mm, odstranljiva sponka omogoča namestitev tipala npr. v kabelski cevi, izklopi črpalke, ko temperatura pade pod 25°C. Merilno območje -50 do 100°C. Napajanje 1xCR2, brezžična komunikacija ZigBee 2.4GHz, dolžina kabla 470mm. Dim.: 73,5x24,7x20mm.

Koda	Naziv	EAN: 5060103694440	Cena
------	-------	--------------------	------

<b>SW600</b>	Senzor okna / vrata, tanka izvedba		<b>79,06</b>
--------------	------------------------------------	--	--------------

Brezžični senzor za kontrolo ogrevanja pri odprtih oknih / vratih z aplikacijo (izklopljene luči in termostati, obveščanje preko e-mail, SMS). Uporaba z UGE600 in Salus Smart Home aplikacijo. Napajanje: 1 x CR2 3V akumulator. Signal Zigbee 2.4Ghz. Delovna temperatura: 0-40°C. Dimenzije: Senzor š=22mm, v=70mm, g=20mm, Magneti: š=11mm, v=41mm, g=10mm

Koda	Naziv	EAN: 5060103697083	Cena
------	-------	--------------------	------

<b>WLS600</b>	Tipalo izliva vode		<b>75,64</b>
---------------	--------------------	--	--------------

Tipalo je zasnovano z namenom zaznave prisotnosti vode na površini pod tipalom ali na kablh, ki so povezani s tipalom. Namesti se lahko vodoravno ali navpično. Povezava z aplikacijo omogoča prejetje brezplačnih obvestil v primeru puščanja ali poplave (SMS, e-mail). Popolno odporen na vodo, različne vrste sestavljanja (dodatki vključeni). Napajanje 1 x CR2, komunikacija brezžična ZigBee, dolžina zunanega senzorja 2m, dim. viš. 25mm, ø55mm, ohišje 60x66x30mm.





## SERIJA SMART HOME (iT600RF)

Koda	Naziv	EAN: 5060103698783	Cena
------	-------	--------------------	------

<b>DI600</b>	Krmilnik razsvetljave s funkcijo zatemnjevanja (dimmer)		<b>79,54</b>
--------------	---	--	--------------

Naprava je namenjena upravljanju z razsvetljavo. Ima funkcijo uravnavanja intenzitete razsvetljave (dimmer). Možnost daljinskega vklopljanja/izklopljanja razsvetljave ter zatemnjevanja na podlagi brezžične komunikacije, in lokalnega upravljanja z uporabo vgrajenega stikala za luč. Deluje skupaj z internetnim prehodom UGE600 in aplikacijo SALUS Smart Home. Montaža se v stikalno omarico. Stikalo za vklop napajanja razsvetljave, uravnavanje intenzitete svetlosti, deluje kot repeater omrežja ZigBee, ima nastavljen urnik v aplikaciji SALUS Smart Home. Napajanje: 230V AC 50Hz. Maks. obremenitev: 1,5 A. Maks. moč svetlobnih virov: LED 200W halogen 400W. Komunikacija: brezžična ZigBee 2,4 GHz. Mere [mm]: 45,5 x 45 x 20,3.

Koda	Naziv	EAN: 5060103696956	Cena
------	-------	--------------------	------

<b>SD600</b>	Detektor dima		<b>71,98</b>
--------------	---------------	--	--------------

Uporablja se za zaznavo prisotnosti dima v realnem času. Detektor je možno uporabljati kot samostojno enoto (brez internetnega prehoda UGE600). Obvešča o zaznanih grozljah (zvočni in svetlobni alarm), sinhroniziran z internetnim prehodom UGE600 in aplikacijo SALUS Smart Home, omogoča sprotno obveščanje o stanju (SMS in e-mail), za hotele, skladišča). Napajanje 1 x CR2, komunikacija brezžična ZigBee, raven hrupa <85dB, delovna temp. -10-50°C, dim. 60x60x49mm.

Koda	Naziv	EAN: 5060103698097	Cena
------	-------	--------------------	------

<b>MS600</b>	Brezžični senzor gibanja		<b>83,08</b>
--------------	--------------------------	--	--------------

Brezžični senzor za zaznavanje gibanja. Za pravilno delovanje senzorja sta potrebna internetni prehod UGE600 in aplikacija SALUS SmartHome. Preko aplikacije lahko na daljavo spremljamo prisotnost oseb v prostoru in prejemo obvestila SMS/e-mail. OneTouch lahko napravam, kot sta SPE600 ali SR600, senzor gibanja vklopi/izklopi katero koli električno napravo, (luči, ko zazna prisotnost na stopnicah, ali gibanje v kopalnici). Odporen proti živalim do 35kg. Napajanje 1 x CR2, komunikacija brezžična ZigBee 2,4GHz, območje detekcije 8m, kot zaznavanja gibanja 80°, dim. 60,45 x 80,52 x 43,18mm.

Koda	Naziv	EAN: 5060103693665	Cena
------	-------	--------------------	------

<b>SB600</b>	Pametni gumb, baterijsko napajanje		<b>55,39</b>
--------------	------------------------------------	--	--------------

Brezžični, za aktiviranje dveh različnih OneTouch pravil, aktivira po dva dogodka, npr. izklop ogrevanja, vklop urnika, vklop osvetlitve (brez prehoda in aplikacije). Obveščanje preko SMS ali e-mail. Napajanje 2 x AAA baterije, komunikacija brezžična ZigBee 2,4GHz, dim. 59 x 19 x 19mm.

Koda	Naziv	EAN: 5060103693658	Cena
------	-------	--------------------	------

<b>FC600</b>	Brezžični sobni termostat za konvektorje, bel		<b>150,06</b>
--------------	---	--	---------------

Za krmiljenje 2- in 4-cevni ventilatorskih stenskih konvektorjev, talnih konvektorjev ali grelnikov vode z vgrajenim ventilatorjem. Krmili ventilator in ventila za vzdrževanje željene temperature. Deluje z internetno povezavo s prehodom UGE600 in aplikacijo SmartHome. Nastavljen kot dnevni termostat z možnostjo tedenskega načina. razširi ZigBee območje. Napajanje 230V AC 50Hz, brezžična komunikacija ZigBee 2.4GHz. Max. obremenitev 5(2)A, krmilni izhodi (hitrosti in pogon) 230V AC 50Hz, razpon nastavljene temperature 5-40°C, natančnost prikaza temperature 0,1...0,5°C. Dim.: 86 x 86 x 46mm, nadometna debelina 16,5mm.

Koda	*Po naročilu Naziv	EAN: 5060103694587	Cena
------	--------------------	--------------------	------

<b>FC600-M 0-10V *</b>	Modul za ventilatorje		<b>89,06</b>
------------------------	-----------------------	--	--------------

Modul za ventilatorske konvektorje, talne konvektorje ali grelnike z ventilatorji na signal 0-10V. Dopolnjuje glavni termostat FC600. Upravlja hitrost ventilatorja z EC motorjem - določa napetost od 0 - 10V. Upravlja dva električna pogona (ventil ogrevanja in hlajenja), pretvarja signal 230V AC /24V DC. Napajanje 24V DC. Vhodi (230V AC): F1, F2, F3 - nizki, srednji, visoki tek ventilatorja; V1, V2 -pogoni ventilov ogrevanje in hlajenje. Izhodi: napajanje ventilatorja 24V DC, 6,5A; krmiljenje ventilatorja 0...10V; pogoni za ventila ogrevanje/hlajenje 24V DC, 1A. Namestitev: rele DIN 35mm. Dimenzije 51x90x65mm.

## SERIJA SMART HOME HTR - brezžični sistem

Koda	Naziv	EAN: 5060103694402	Cena
------	-------	--------------------	------

<b>HTR-RF20</b>	Brezžični elektronski sobni termostat, baterijski		<b>65,88</b>
-----------------	---	--	--------------

Sobni termostat, nadometni, v povezavi s KL08RF regulira talno gretje, ali se povezuje z iT600RF napravami preko ZigBee signala (2,4 GHz). Precizno ohranja temperaturo (algoritem TPI), lahko se priključi v vsaki fazi naložbe, ima funkcijo ustvarjanja časovnih načrtov. Omogoča nadzor preko interneta z aplikacijo Smart Home in prehodom UGE600. V Offline načinu preko enote CO10RF deluje kot dnevni termostat. Območje temp. 5°C - 32,5°C, napajanje 2 xAA baterije, dim. 80 x 85 x 32,5 mm.

Koda	Naziv	EAN: 5060103694273	Cena
------	-------	--------------------	------

<b>HTRS-RF30</b>	Brezžični digitalni sobni termostat, dnevni, baterijski		<b>96,38</b>
------------------	---	--	--------------

Nadometni dnevni sobni termostat. Brezžična komunikacija ZigBee2,4GHz preko aplikacije SmartHome in prehoda UGE600. Offline deluje preko enote CO10RF (kot dnevni termostat). Funkcije ustvarjanja časovnih načrtov, nočni način, opcijsko talni senzor. Precizno ohranja temperaturo-algoritem TPI, vhod za dodatni senzor temp. tal ali zraka. Temp. območje 5-35°C, napajanje 2 x AA baterije, natančnost prikaza temp. 0,5°C, komunikacija ZigBee 2,4GHz, dim. 80 x 85 x 25mm.

Koda	Naziv	EAN: 5060103694280	Cena
------	-------	--------------------	------

<b>HTRP-RF50</b>	Brezžični digitalni termostat, za talno ogrevanje, baterijski		<b>105,41</b>
------------------	---	--	---------------

Nadometni dnevni termostat za talno ogrevanje za priključni modul KL08RF, glava TRV in krmilni modul RX10RF. Brezžična komunikacija ZigBee2,4GHz preko aplikacije SmartHome in prehoda UGE600. Offline deluje preko enote CO10RF (kot dnevni termostat). Časovni načrt, nočni način, opcijsko talni senzor. Precizno ohranja temperaturo-algoritem TPI, vhod za dodatni senzor temp. tal ali zraka. Temp. območje 5-35°C, napajanje 2 x AA baterije, natančnost prikaza temp. 0,5°C, komunikacija ZigBee 2,4GHz, dim. 80 x 85 x 25mm. 5 let garancije.





## SERIJA SMART HOME HTR - brezžični sistem

Koda	Naziv	EAN: 5060103693368	Cena
<b>ECM600</b>	Merilnik električne energije		<b>195,20</b>
Zaznava 1 ali 3 faze, v enofaznem načinu lahko meri skupno porabo ali 3 ločene porabnike. Deluje preko aplikacije SmartHome in prehoda UGE600. Temp. območje -10-50°C, napajanje 4 x AA baterije, komunikacija ZigBee 2,4GHz, dim. 120 x110 x 38mm. 5 let garancije.			
Koda	Naziv	EAN: 5060103692750	Cena
<b>08RFA</b>	Zunanja antena za modul KL08RF / KL10RF		<b>25,86</b>
Za ojačitev signala pri veliki razdalji za priključna modula KL08RF in KL10RF z ostalim IT600 sistemom preko ZigBee signala. Dimenzije višina 131mm, ø29mm, dolžina kabla 100cm, namestitvev magnet, vtič SMA-K.			
Koda	Naziv	EAN: 5060103694150	Cena
<b>SRS600</b>	Stensko ohišje za montažo SR600/RS600/RE600		<b>11,22</b>
Nadometno ohišje za repetitor RE600 ali podometni rele SR600 za zaščito pred izvlekom kablov in zunanjim poškodovanjem.			



## SERIJA EXPERT NSB

Koda	Naziv	EAN: 5060103698752	Cena
<b>CB500</b>	Priključni modul za talno ogrevanje (5 conski)		<b>112,00</b>

CB500 je glavni element za krmiljenje talnega ogrevanja ali hlajenja. Z montažo dodatnih enot se lahko število neodvisnih temperaturnih con poveča. Upravlja do 15 temperaturnih con (priključni modul CB500 + dva razširitvena modula CB500X). Breznapetostni izhodi za krmiljenje kotla, toplotne črpalke ali hladilnega sistema. Preklop med načinom ogrevanja in hlajenja. Krmilna omarica je zasnovana za montažo NC (normalno zaprtih) pogonov. Nadzor 5 neodvisnih temperaturnih območij, nadzor toplotne črpalke, krmiljenje ogrevanja ali hlajenja, napredni krmilniki za kotel, hlajenje in toplotno črpalke. Enostavna montaža vodnikov z vzmetnimi sponkami, varovanje pred nezaželenim izvlekom, montaža na steno ali DIN letev. Napajanje 230V AC, 50Hz, maks. obremenitev 7A. Vhodi: preklop ogrevanje / hlajenje breznapetostni, tipalo rosišča. Izhodi: krmiljenje kotla breznapetostni, nadzor toplotne črpalke / hlajenje breznapetostni, krmiljenje črpalke (AC 230V), pogoni (AC 230V). Dimenzije [mm] 270 x 110 x 55.

Koda	Naziv	EAN: 5060103698776	Cena
<b>CB500X</b>	Razširitveni modul talnega ogrevanja (5 conski)		<b>85,64</b>

CB500X je krmilni element talnega ogrevanja ali hlajenja, namenjen krmiljenju virov ogrevanja in hlajenja. Omogoča neodvisno nadzorovanje 5 temperaturnih con. Na obstoječi priključni modul CB500 lahko povežete največ 2 razširitvena modula CB500X in s tem upravljate 15 temperaturno neodvisnih con, ter vira ogrevanja in hlajenja. Vzmetne sponke za enostavno povezavo ožičenja. Krmilna omarica je zasnovana za montažo NC (normalno zaprtih) pogonov. Varovanje vodnikov pred nezaželenim izvlekom, kompatibilnost s priključnim modulom CB500, montaža na steno ali DIN letev. Napajanje 230V AC, 50Hz. Maks. obremenitev 1A. Izhodi: pogoni (AC 230V). Dimenzije [mm] 270 x 110 x 55.



Koda	Naziv	EAN: 5060103692552	Cena
<b>VS30W</b>	Žični programski termostat		<b>98,82</b>

Podometni termostat nadzira površinsko ogrevanje in hlajenje. Deluje s priključnim modulom KL08NSB ali KL06-M (230V). Sodeluje s pogoni NC ali NO. Za zaščito pred previsoko ali prenizko temp. se uporablja dodatni talni senzor FS300. Funkcije časovnih načrtov, krmilni dnevne termostate, nočni in varčni način in zaščita pred zmrzovanjem. Ščiti termostatične ventile VP. Napajanje 230V AC 50Hz, maksimalna obremenitev 3A, krmilni izhodi (hitrosti in pogon) 230V AC 50Hz, razpon nastavljene temperature 5-35°C, natančnost prikaza temperature 0,5°C, žična komunikacija. Dimenzije: 86x86x42mm, podometna doza ø60 mm.



## SERIJA EXPERT HTR

Koda	Naziv	EAN: 5060103693344	Cena
<b>HTRP230(50)</b>	Žični sobni digitalni termostat, tedenski, bel		<b>72,47</b>

Podometni termostat nadzira površinsko ogrevanje in hlajenje. Deluje s priključnim modulom KL08NSB ali KL06-M (230V). Sodeluje s pogoni NC ali NO. Za zaščito pred previsoko ali prenizko temp. se uporablja dodatni talni senzor FS300. Funkcije časovnih načrtov, krmilni dnevne termostate, nočni in varčni način in zaščita pred zmrzovanjem. Ščiti termostatične ventile VP. Napajanje 230V AC 50Hz, maksimalna obremenitev 3A, krmilni izhodi (hitrosti in pogon) 230V AC 50Hz, razpon nastavljene temperature 5-35°C, natančnost prikaza temp. 0,5°C, žična komunikacija. Dim.: 85x85x25mm, podometna doza ø60 mm.



Koda	Naziv	EAN: 5060103693337	Cena
<b>HTRS230(30)</b>	Žični sobni digitalni termostat, dnevni, bel		<b>61,98</b>

Podometni termostat nadzira površinsko ogrevanje in hlajenje. Deluje s priključnim modulom KL08NSB ali KL06-M (230V). Sodeluje s pogoni NC ali NO. Za zaščito pred previsoko ali prenizko temp. se uporablja dodatni talni senzor FS300. Preko modula zniža določeno temperaturo, ko prejme signal NSB iz tedenskega termostata. Zaščita pred zmrzovanjem. Ščiti termostatične ventile VP. Napajanje 230V AC 50Hz, maksimalna obremenitev 3A, krmilni izhodi (hitrosti in pogon) 230V AC 50Hz, razpon nastavljene temperature 5-35°C, natančnost prikaza temp. 0,5°C, žična komunikacija. Dim.: 85x85x25mm, podometna doza ø60 mm.



## REGULACIJA TALNEGA OGREVANJA EXPERT

Koda	Naziv	EAN: 4047795600004	Cena
<b>KL06-M 230V</b>	Priključni žični modul, 6 con, talno ogrevanje		<b>71,25</b>

Modul za talno ogrevanje. Za 6 kontrolnih območij, 24 izhodov za povezavo pogonov (4 pogoni na cono). Z moduli PL06/PL07 (nista vključena) lahko krmili obtočno črpalke in bojler. Povezava z vtičakem z razbremenitvijo. Deluje v povezavi s pogoni NC. Breznapetostni vklop boilerja in črpalke. Dim.: 300x86x60mm. Napajanje 230V AC 50Hz. Najvišja obremenitev 2(1)A. Izhodi za pogone: 230V AC 50Hz.





## REGULACIJA TALNEGA OGREVANJA EXPERT

Koda	Naziv	EAN: 4047795600004	Cena
<b>PL06-QL</b>	Modul za črpalko ali kotel (za KL06)		<b>29,04</b>

Za krmiljenje obtočne črpalke in kotla prek breznapetostnih kontaktov NC/COM/NO. Izhod COM/NO se zapre, ko katerikoli kontakt povprašuje po toploti. Odpre se, ko termostati nehalo signalizirati potrebo po ogrevanju. Možnost izbire con, združljiv s priključnimi moduli KL06 za 230V in 24V. Napajanje prek KL06, najvišja obremenitev 5(2)A, izhodni signal NO/COM/NC, dim. 60x80x20mm.

Koda	Naziv	EAN: 4047795640000	Cena
<b>PL07-QL</b>	Modul za krmiljenje kotla in črpalke KL06		<b>47,46</b>

Za krmiljenje obtočne črpalke in kotla individualno prek breznapetostnih kontaktov NC/COM/NO. Izhod COM/NO se zapre, ko katerikoli kontakt povprašuje po toploti. Odpre se, ko termostati nehalo signalizirati potrebo po ogrevanju. Združljiv s priključnimi moduli KL06 za 230V in 24V. Napajanje prek KL06, najvišja obremenitev 5(2)A, izhodni signal 2 x rele NO/COM/NC, dim. 60x80x20mm.

Koda	Naziv	EAN: 4047795110008	Cena
<b>RT10-230V</b>	Žični dnevni sobni termostat, elektronski		<b>27,69</b>

Podometni termostat nadzira površinsko ogrevanje in hlajenje. Preko žičnega modula zniža določeno temperaturo, ko prejme signal NSB iz tedenskega termostata. Napajanje 230V AC 50Hz, maksimalna obremenitev 3A, krmilni izhodi (hitrosti in pogon) 230V AC 50Hz, razpon nastavljene temp. 5-30°C, natančnost prikaza temperature 0,5°C, žična komunikacija. Dimenzije: 85x85x30mm, podometna doza ø60 mm.

## DODATNA OPREMA ZA TALNO OGREVANJE

Koda	Naziv	EAN: 5903669087311	Cena
<b>RM-16A</b>	Relejni modul 16A (napetostni / breznapetostni kontakt)		<b>26,84</b>

Modul za vklop/izklop električnih naprav. Krmiljene ogrevalne naprave (tipa ON/OFF) s priklopom na rele termostata 230V AC iz serije EXPERT NSB, HTR, BTR, HTRP/BTRP. Krmiljenje trajnožarečega kotla (ki zahteva kontakt NO/COM) s priklopom na relejni modul RM-16A termostata z izhodom COM/NO (npr. T105). Povezava sprejemnika z večjo močjo od tiste, ki jo dovoljuje rele v termostatu. Najvišja tokovna poraba ne sme presežati 16A. Priklop priključnega modula (KL06/KL08NSB/KL08RF) z večjim številom pogonov ali drugih naprav, priključenih na ta modul, da se razbremenijo njegovi kontakti (črpalke, pogoni, električne grelne podloge). Napajanje 230V AC 50Hz, maksimalna obremenitev 16A/250V AC, povezava z breznapetostnim relejem NO/COM, napetostni vhod SL 230V AC, izhodni signal rele 230V AC, dim.: 47x47x20mm.

Koda	Naziv	EAN: 8592920000717	Cena
<b>FS300</b>	Talni senzor - temperaturno tipalo, dolžina 3m		<b>10,61</b>

Talno tipalo za namestitve v tleh za daljinsko merjenje temperature zraka v prostoru. Kompatibilno za serije: EXPERT HTR (HTRP230, BTRP230); EXPERT NSB (VS30W, VS30B, VS35W, VS35B); SmartHome (SQ610, SQ610RF, VS10WRF, VS10BRF, VS20WRF, VS20BRF, HTRS-RF(30), HTRP-RF(50), TS600); Termostat za ventilatorski konvektor FC600. Merilno območje -10-100°C, merilni element NTC 10kΩ, dolžina kabla 3m, prerez žice 2 x 0,5mm.

## TERMOSTATI - serija RT

Koda	Naziv	EAN: 5060103693580	Cena
<b>RT510</b>	Žični elektronski termostat, tedenski		<b>58,32</b>

Za žično krmiljenje ogrevalnih naprav (neposredno povezan s kotlom). Funkcije: časovni načrt, začasna sprememba temperature, način zaščita pred zmrzovanjem (razpon temperature 5-17°C), počitnice in mirovanje. Samodejno povezovanje. Nadometna montaža. Napajanje 2 x AA baterije. Maksimalna obremenitev 3(1)A. Izhodni signal rele NO/COM/NC. Temperaturno območje 5-35°C. Temperaturna natančnost 0,1 ali 0,5°C. Histereza ±0,25°C. Komunikacija žična. Dimenzije: 120x96x27mm.

Koda	Naziv	EAN: 5060103693603	Cena
<b>RT510RF</b>	Brezžični elektronski sobni termostat, tedenski		<b>109,43</b>

Za brezžično krmiljenje ogrevalnih naprav, opremljenih z vhodom za termostat ON/OFF. Priporočljiv za plinski ali oljni kotel. Krmilni algoritem TPI, samodejno ponavlja signal, deluje po časovnem načrtu, način zaščita pred zmrzovanjem (razpon temperature 5-17°C), način počitnice in mirovanje. Napajanje oddajnika 2 x AA baterije, sprejemnika 230V AC 50Hz. Maksimalna obremenitev 16(5)A. Izhodni signal rele NO/COM/NC. Temperaturno območje 5-35°C. Temperaturna natančnost 0,1 ali 0,5°C. Histereza ±0,25°C. Komunikacija brezžična (868MHz). Dimenzije: oddajnik (RT510TX) 120x96x27mm, sprejemnik (RXRT510) 96x96x27, s stojalom. Že tovarniško povezan za delovanje.

Koda	Naziv	EAN: 5060103694204	Cena
<b>RT510SPE</b>	Brezžični elektronski sobni termostat, tedenski, sprejem. vtičač		<b>133,10</b>

Za brezžično krmiljenje ogrevalnih naprav, ki imajo kabel z vtičem (el.grelniki, obtočne črpalke). Priporočljiv za črpalko. Krmilni algoritem TPI, samodejno ponavlja signal, deluje po časovnem načrtu, način zaščita pred zmrzovanjem (razpon temperature 5-17°C), način počitnice in mirovanje. Napajanje oddajnika 2 x AA baterije, sprejemnika 230V AC 50Hz. Maksimalna obremenitev 16(5)A. Izhodni signal rele NO/COM/NC. Temperaturno območje 5-35°C. Temperaturna natančnost 0,1 ali 0,5°C. Histereza ±0,25°C. Komunikacija brezžična (868MHz). Dimenzije: oddajnik (RT510TX) 120x96x27mm, sprejemnik (SPE868) 42x77x42. Že tovarniško povezan za delovanje.

Koda	Naziv	EAN: 5060103695713	Cena
<b>RT510SR</b>	Brezžični elektronski sobni termostat, tedenski, sprejem. rele		<b>116,88</b>

Za brezžično krmiljenje električnih ogrevalnih naprav. Priporočljiv za grelne plošče, električne grelnike. Krmilni algoritem TPI, samodejno ponavlja signal, deluje po časovnem načrtu, način zaščita pred zmrzovanjem (razpon temperature 5-17°C), način počitnice in mirovanje. Napajanje oddajnika 2 x AA baterije, sprejemnika 230V AC 50Hz. Maksimalna obremenitev 16(5)A. Izhodni signal rele NO/COM. Temperaturno območje 5-35°C. Temperaturna natančnost 0,1 ali 0,5°C. Histereza ±0,25°C. Komunikacija brezžična (868MHz). Dimenzije: oddajnik (RT510TX) 120 x 96 x 27mm, sprejemnik rele (SR868) 44x44x26. Že tovarniško povezan za delovanje.



## INTERNETNI TERMOSTATI - serija RT

Koda	Naziv	EAN: 5060103693733	Cena
<b>RT310i</b>	Internetni brezžični sobni termostat		<b>193,74</b>

Za krmiljenje električnih ogrevalnih naprav preko interneta preko aplikacije RT310i. Port 1x10/100 LAN. Za naprave z vvhodom ON/OFF. Krmilni algoritem TPI, samodejno ponavlja signal, način zaščita pred zmrzovanjem (razpon temperature 5-9°C). Napajanje oddajnik 2 x AA baterije, sprejemnik 230V AC 50Hz, prehod 5VDC. Maksimalna obremenitev 16(5)A. Temperaturno območje 5-35°C. Histereza ±0,25°C. Temperaturna natančnost 0,1 ali 0,5°C. Komunikacija brezžična (868MHz). Dimenzije: oddajnik (RT310TX) 96x96x27mm, sprejemnik (SR868) 96x96x27. Internetni prehod (iTG310) 39x91x25mm, podstavek. Že tovarniško povezan za delovanje.

Koda	Naziv	EAN: 5060103694211	Cena
<b>RT310iSPE</b>	Internetni brezžični sobni termostat, sprejemnik vtič		<b>217,40</b>

Za krmiljenje električnih ogrevalnih naprav preko interneta preko aplikacije RT310i, Port 1x10/100 LAN. Za naprave, ki imajo kabel z vtičem (električni grelniki, obtočne črpalke). Krmilni algoritem TPI, samodejno ponavlja signal, način zaščita pred zmrzovanjem (razpon temperature 5-9°C). Napajanje oddajnik 2 x AA baterije, sprejemnik 230V AC 50Hz, prehod 5VDC. Maksimalna obremenitev 16(5)A. Temperaturno območje 5-35°C. Temperaturna natančnost 0,1 ali 0,5°C. Komunikacija brezžična (868MHz). Histereza ±0,25°C. Dimenzije: oddajnik (RT310TX) 96x96x27mm, sprejemnik vtič Schuko (SPE868) 96x96x27, internetni prehod (iTG310) 39x91x25mm, podstavek. Že tovarniško povezan za delovanje.

Koda	Po naročilu Naziv	EAN: 5060103693733	Cena
<b>RT310iSR *</b>	Internetni brezžični sobni termostat, sprejemnik rele		<b>197,64</b>

Za krmiljenje električnih ogrevalnih naprav preko interneta preko aplikacije RT310i. Port 1x10/100 LAN. Priporočljiv za grelne plošče, električne grelnike. Krmilni algoritem TPI, samodejno ponavlja signal, način zaščita pred zmrzovanjem (razpon temperature 5-9°C). Napajanje oddajnik 2 x AA baterije, sprejemnik 230V AC 50Hz, prehod 5VDC. Maksimalna obremenitev 16(5)A. Temperaturno območje 5-35°C. Temperaturna natančnost 0,1 ali 0,5°C. Histereza ±0,25°C. Komunikacija brezžična (868MHz). Dimenzije: oddajnik (RT310TX) 96x96x27mm, sprejemnik rele (SR868) 44x44x26, internetni prehod (iTG310) 39x91x25mm, podstavek. Že tovarniško povezan za delovanje.

## INTERNETNI TERMOSTATI - serija iT

Koda	Naziv	EAN: 5060103691852	Cena
<b>iT500</b>	Internetni sobni termostat za 2 coni		<b>301,83</b>

Za krmiljenje CO in časovno krmiljenje TSV ene ali dveh neodvisnih con ogrevanja, ali ena cona + topla voda z dodatnim modulom iT300; preko aplikacije iT500Plus za telefon ali PC. ECO in HOLIDAY način. Obseg temperature 5-35°C, zaščita proti zmrzali. Napajanje: termostat iT500TR - 2xAA bateriji, sprejemnik iT500RX - 230V AC 50Hz, prehod iTG500 z napajalnikom 230V AC 50Hz. Maks. obremenitev CH1:16A uporabno, 5A induktivno, CH2: 5A uporabno, 3A induktivno. Izhod 2 x rele NO/COM/NC. V paketu: termostat iT500TR dim. 128x95x30mm; brezžični sprejemnik iT500RX (se priključi na kotel); dim. 150x100x35mm, internetni prehod iTG500, dim. 39x91x25mm; antena: 70mm.

Koda	Naziv	EAN: 5060103691869	Cena
<b>iT300</b>	Brezžično temperaturno tipalo druge cone za iT500		<b>51,48</b>

Za delovanje z internetnim termostatom iT500 ali brezžičnim termostatom XT500 za krmiljenje druge ogrevalne cone. Napajanje baterije 2 x AAA, brezžična komunikacija, dimenzije 76x76x22mm.

## TERMOSTATI - serija STANDARD

Koda	Naziv	EAN: 5060103690053	Cena
<b>RT200</b>	Žični elektronski termostat, dnevni		<b>29,28</b>

Nadometni žični termostat za krmiljenje naprav z napetostjo 230V. Delovanje prikazano s signalizacijskim LED-obročem. Napajanje 230V AC 50Hz, najvišja obremenitev 3(1)A SPST, izhod 230V AC 50Hz, temperaturno območje 5-35°C, dimenzije 95x95x40mm.

Koda	Naziv	EAN: 5060103690947	Cena
<b>091FLV2</b>	Žični elektronski sobni termostat - tedenski		<b>55,39</b>

Za žično krmiljenje ogrevalnih naprav (plinski, oljni kotli, toplotne črpalke) in hladilnih naprav. Priključi se neposredno na napravo. 9 programov, 3 temperaturne ravni, način ogrevanje/hlajenje. Napajanje 2xAA bateriji, maksimalna obremenitev 5(3)A, breznapetostni rele NO/COM, temperaturno območje 5-30°C, temperaturna natančnost 0,2°C; žična komunikacija; dimenzije termostata: 154x80x30mm.

Koda	Naziv	EAN: 5060103696314	Cena
<b>091FLRFV2</b>	Brezžični digitalni sobni termostat, programski		<b>106,99</b>

Za žično krmiljenje ogrevalnih naprav (plinski, oljni kotli, toplotne črpalke) in hladilnih naprav. Sodeluje z vtiči SPE868 in relejem SR868. Priključi se neposredno na napravo. 9 programov, 3 temperaturne ravni, način ogrevanje/hlajenje. Napajanje oddajnik 2xAA bateriji, sprejemnik 230V AC 50Hz; maksimalna obremenitev 16(5)A, breznapetostni rele NO/COM, temperaturno območje 5-30°C, temperaturna natančnost 0,2°C; brezžična komunikacija 868MHz; dimenzije: oddajnik 154x80x30mm, sprejemnik RXRT510 96x96x27mm.

Koda	Naziv	EAN: 5060575650005	Cena
<b>RR868</b>	Brezžični krmilni set - stikalo		<b>84,91</b>

Komplet je namenjen brezžičnemu posredovanju signala o delovanju ali okvari električnih naprav, npr. črpalke, ventilatorjev, osvetlitve. Idealna rešitev povsod, kjer ni mogoča žična napeljava. Oddajnik in sprejemnik se lahko namestita v dozi φ 60 mm in sta že tovarniško povezana. Napajanje 230V AC 50Hz, maksimalna obremenitev 5(3)A, izhodni signal sprejemnika 230V AC, brezžična komunikacija 868MHz; dimenzije oddajnik 45x45x20mm, sprejemnik 84x84x20mm.

## TERMOSTATI - serija STANDARD

Koda Naziv EAN: 8592920000755 Cena

**PC12HW** Termostat za 2 črpalke (CO in TSV) **98,82**

Termostat - krmilnik se vključi, ko temperatura kotla preseže prednastavljeno temperaturo za vklop črpalke in deluje do izravnave temperature kotla in zalogovnika ali do nastavljene temp. zalogovnika. Izpiše izmerjeno temperaturo, možnost ročni način, deluje v poletnem načinu (omeji črpalke), funkcija anti-stop, optimizira temperaturo vode, zvočni alarm ob previsoki temperaturi, enostavna uporaba-3 tipke. Napajanje: 230V AC 50Hz. Poraba energije: 2W. Temp.okolja -10 do 50°C. Temp.razpon: 0-99 °C. Nastavljivo temp.območje 5-80°C za C in TSV. Najvišja obremenitev 6 A. Dolžina kabla 1,2m. Dimenzije 155x70x35mm.

Koda Naziv EAN: 5060103691524 Cena

**AT10** Cevni termostat mehanski naležni 230V **20,50**

Mehanski naležni termostat za vklop obtočnih črpalk, kotla, aktiviranje ventilov ali kot zaščitni termostat pri talnem ogrevanju za izklop obtočne črpalke v primeru zaznave previsoke temperature vode. Gumb za enostavno spreminjanje temperature. Temperaturno območje 30 - 90°C. Napajanje 230V AC 50Hz, maksimalna obremenitev 16(4)A, izhodni signal kontakti NO/COM/NC, dimenzije 105x45x50mm.

Koda Naziv EAN: 5060103691531 Cena

**AT10F** Cevni termostat naležni s kapilaro 230V **21,84**

Mehanski naležni termostat z zunanjim temperaturnim tipalom (kapilara) za vklop obtočnih črpalk, kotla, aktiviranje conskih ventilov oz. preklonih ventilov med polnjenjem zalogovnikov TSV, ali kot zaščitni termostat. Gumb za enostavno spreminjanje temperature. Temperaturno območje 30 - 90°C, napajanje 230V AC 50Hz, maksimalna obremenitev 16(4)A, izhodni signal kontakti NO/COM/NC, dimenzije 105x45x50mm, dolžina kapilare 1200mm, ø kapilare 7mm.

## VREMENSKI REGULATOR

Koda ODPRODAJA Naziv EAN: 5060103695287 / 5060103698059 Cena

**MULTIMIX3000** Vremenski regulator Multi Mix **587,77**

**CT10-X 3M** Tipalo, dolžina 3m **21,23**

Regulator ogrevanja za posamezne ali skupino ogrevalnih virov (plin, olje, peleti, toplotne črpalke, kamini, lesnoupinjevalni kotli). Regulira do dva vira ogrevanja, dva ogrevalna kroga, sanitarno vodo, zalogovnik, sončne kolektorje, oz.: 6 izhodov za obtočno črpalke, 2 mešalna ventila 230V, 4 napetostni izhodi 230V. Breznepetostni izhod (NO/COM/NC): nadzor glavnega vira ogrevanja. Stopnja zaščite: IP20. Temp. okolice: 50°C. Dimenzije: 340x225x60mm. Tipalo za merjenje temp.tekočine se namesti na cev ali v posodo, merilno območje 0-100°C, merilno območje NTC 10kΩ, dolžina kabla 3m, prerez žice 2 x 0,5mm.

Koda Po naročilu Naziv EAN: 5060103694037 Cena

**WT100** \* Vremensko voden termostat s tipali **260,59**

Regulira temperaturo v ogrevalni zanki s 3-potnim ali 4-potnim ventilom, opremljen s tritočkovnim pogonom. Samodejno prepozna začetek ogrevalne sezone. Nadzira delovanje črpalke. Funkcije: urnik, zaščita proti zmrzali, zaščita črpalke v času daljšega mirovanja. Možnost dodatne obtočne črpalke in krmiljenje preko breznapetostnega kontakta. Sodeluje z vsemi termostati tipa ON/OFF. Napajanje: 230V AC / 50Hz. Maks. obremenitev: 3A. Vhodi: T1-temp. napajanja; T2-zunanja temp.; T3-povratna temp.; T4-temp.kotla (sklopke); TP-vhod za sobni termostat (ON/OFF). Izhodi: Toplotna črpalka 230V/1,5A, pogon z mešalnim ventilom 230V/0,5A; vir toplote rele NO/COM. Temp. okolja: T40. Stopnja zaščite: IP20. Dimenzije: 140 x 95 x 40mm. V kompletu: tipalo zunanje temp. CT6-P, naležno tipalo CT10-X (2kosa).

## TERMoeLEKTRIČNI POGONI 230V

Koda Naziv EAN: 5060103691920 Cena

**T30NC230V** Termoelektrični pogon - zaprt NC 230V **22,45**

Za uporabo s termostatičnimi ventili v delniku za talno ogrevanje ali z obhodnimi ventili. Omogoča prekinitev dovoda ogrevalnega medija v del sistema. S sobnimi termostati deluje neposredno ali prek priključnih modulov (žičnih ali brezžičnih). Ko ni napetosti, pogon sklene tokokrog. Funkcija FirstOpen za lažjo namestitvev. Napajanje 230V AC50Hz, Imax. 200mA/200ms, poraba 2W, moč pritiska 100N, čas odpiranja 2min, premik pogona 4mm, navoj M30 x 1,5/M28 x 1,5. Dimenzije 40x70x40, dolžina napajalnega kabla 89cm.

Koda Naziv EAN: 5060103693689 Cena

**THB230V30** Samoregulacijski pogon NC 230V **72,47**

Za talno ogrevanje, z dvema tipaloma na začetku in na koncu zanke samodejno uravnava razliko temperature ( $\Delta T=7^{\circ}C$ ) in prilagaja pretok vode. Napajanje 230V AC50Hz, poraba 0,5W, čas odpiranja 30sek, stopnja zaščite IP54, navoj M30x1,5; dimenzije 93x38x54, dolžina napajalnega kabla 93cm, dolžina kabla za senzorje 45cm.

## PREHODNI / PREKLOPNI MOTORNI VENTILI

Koda Naziv EAN: 5060103694846 / 5060103694839 Navoj Cena

**PMV21** Dvopotni elektromotorni prehodni krogelni ventil DN25 (1") **128,71**

**PMV24** Dvopotni elektromotorni prehodni krogelni ventil DN20 (3/4") **128,71**

Conski ventili za krmiljenje pretoka vode v centralni ogrevalni napravi. Standardni hidravlični in električni priključki. Poraba: 6W. Napajanje: 230V AC / 50Hz. Maks. obremenitev: 3A. Izhod: kontakti NO/COM. Maks.statični tlak: 8,6 bar. Dif. tlak: 1"- 0,8bar, 3/4"- 0,6bar. Odziv: odpiranje 14sek., zapiranje 3sek. Temp.razpon tekočine 5 - 88°C. Pretočni koeficient: 8,6. Stopnja zaščite: IP20. Dimenzije: 87x55x60mm.

Koda Naziv EAN: 5060103694860 / 5060103694853 Navoj Cena

**PMV31** Tripotni elektromotorni preklonni ventil DN25 (1") **153,11**

**PMV34** Tripotni elektromotorni preklonni ventil DN20 (3/4") **153,11**

Tripotni preklonni ventil za krmiljenje pretoka vode v centralni ogrevalni napravi. Standardni hidravlični in električni priključki. Napajanje: 230V AC / 50Hz. Poraba: 6W. Maks.obremenitev: 3A. Izhod: kontakti NO/COM. Maks.statični tlak: 8,6 bar. Diferenčni tlak: 1"- 0,8bar, 3/4"- 0,6bar. Odziv: odpiranje 14sek., zapiranje 3sek. Temp.razpon tekočine 5 - 88°C. Pretočni koeficient: 8,6. Stopnja zaščite: IP20. Dim.: 87x55x60mm.



## TERMOSTATI



Koda	*Po naročilu Naziv	Cena
<b>E10W230WiFi</b>	Programski digitalni termostat, žični WiFi, bel	<b>103,70</b>
<b>E10B230WiFi*</b>	Programski digitalni termostat, žični WiFi, črn	<b>103,70</b>

E10W je termostat za oddaljen nadzor nad ogrevalnim sistemom preko aplikacije ENGO Smart/Tuya Smart. Možnost deljenja naprav več uporabnikom, v aplikaciji na voljo grafi z zgodovino temperatur, možnost določanja minimalne in maksimalne temperature, združljivo z Google Home, Amazon Alexa, prilagodljiva moč osvetlitve zaslona, možnost priklopa dodatnega senzorja NTC, push-sporočila iz aplikacije. Napajanje 230V AC 50Hz. Največja obremenitev 3 (1) A. Razpon nastavljanja temp. 5 – 45°C. Točnost prikaza temp. 0.1°C. Krmilni algoritem TPI ali Histereza (±0.1°C – ±0.5°C). Komunikacija WiFi 2.4 GHz. Vhod S1 – S2: temperatura tal ali merjenje temperature zraka. Izhodni signal: breznapetostni rele NO/COM. Razred zaščite IP30. Dimenzije [mm] 86 x 86 x 39 (14 po namestitvi v dozi s premerom 60).



Koda	Naziv	Cena
<b>E901</b>	Programski elektronski termostat, žični, stenski	<b>79,30</b>

E901 je tedenski nadometni elektronski sobni termostat, namenjen žičnemu upravljanju naprav in ogrevalnih ali hladilnih sistemov. Vzdržuje udobne razmere v prostoru, skladno z urnikom ali programirano zeleno konstantno temperaturo. Priključni se neposredno na napravo. 2 tipa časovnih načrtov, omejitev maksimalne/minimalne temperature, funkcija OGREVANJE/HLAJENJE, možnost izbire med histerezo in vgrajenim algoritmom TPI, programska sprememba vrste releja - normalno odprt (NO) ali navadno zaprt (NC), blokada PIN. Napajanje 2 x AA alkalne baterije. Največja obremenitev 5 (3) A. Izhodni signal breznapetostni rele NO/COM. Razpon nastavljanja temperature 5 – 35°C. Natančnost prikaza temp. 0.1°C ali 0.5°C. Krmilni algoritem TPI ali Histereza (±0.1°C – ±0.5°C). Komunikacija žična. Dimenzije [mm] 150 x 84 x 22.

Koda	Naziv	Cena
<b>E901RF</b>	Programski elektronski termostat, brezžični / prenosni	<b>134,20</b>

E901RF je nadometni tedenski sobni termostat, namenjen brezžičnemu upravljanju naprav in ogrevalnih ali hladilnih sistemov. Tovarniško povezan s sprejemnikom npr. na kotel. V kompletu: oddajnik za termostat (E901TX), sprejemnik za termostat (E901RX). 2 tipa časovnih načrtov, omejitev maks./min. temperature, funkcija OGREVANJE/HLAJENJE, neponovljive komunikacijske kode, omejitev maks./min. temperature, programska sprememba vrste releja - normalno odprt (NO) ali navadno zaprt (NC), blokada PIN, samodejno ponavljanje signala. Delovno območje do 100 m v odprtem prostoru. Napajanje oddajnika 2 x AA alkalne baterije. Napajanje sprejemnika: 230V AC 50Hz. Največja obremenitev 16 (5) A. Izhodni signal: breznapetostni rele NO/COM. Razpon nastavljanja temperature 5 – 35°C. Natančnost prikaza temp. 0.1°C ali 0.5°C. Krmilni algoritem TPI ali Histereza (±0.1°C – ±0.5°C). Komunikacija brezžična, 868 MHz. Dimenzije oddajnika [mm] 150 x 84 x 22. Dimenzije sprejemnika [mm] 96 x 96 x 27.

Koda	Naziv	Cena
<b>E901WiFi</b>	Programski elektronski termostat, WiFi	<b>169,58</b>

Internetni brezžični regulator temperature E901WiFi omogoča ekonomično in ekološko krmiljenje katere koli vrste ogrevanja. Odlikujeta ga pregleden meni in vrsta uporabnih funkcij. Upravljanje z regulatorjem je zelo enostavno in omogoča prilagoditev ogrevanja dnevnemu ritmu uporabnikov. Vgrajen modul WiFi (v sprejemniku) omogoča daljinsko upravljanje grelnega sistema z uporabo aplikacije ENGO Smart / TUYA Smart v pametnem telefonu ali tablici. Omogoča pregled nad stanjem stikala sprejemnika, ki se ga poveže npr. s kotlom. Naprave so tovarniško pripravljene za uporabo. V sestavu: oddajnik regulatorja (E901TXWIFI), sprejemnik regulatorja (E901RXWIFI), podstavek regulatorja. Možnosti: izbira med histerezo ali vgrajenim algoritmom TPI, programska sprememba tipa releja, blokada PIN, številne funkcije, ki so na voljo v aplikaciji ENGO Smart / Tuya Smart, omejitev najvišje / najnižje temperature, funkcija GRETJE/HLAJENJE, neponovljive kode za prenos, samodejno ponavljanje signal delovanja. Napajanje oddajnika 2 x AA alkalne baterije. Napajanje regulatorja: 2x AA alkalne baterije. Napajanje sprejemnika: 230V AC 50Hz. Največja obremenitev 16 (5) A. Izhodni signal: breznapetostni rele NO/COM. Razpon nastavljanja temperature 5 – 35°C. Natančnost prikaza temp. 0.5°C. Krmilni algoritem TPI ali Histereza (±0.25°C – ±0.5°C). Komunikacija brezžična, 868 MHz in WiFi. Dimenzije oddajnika [mm] 150 x 84 x 22. Dimenzije sprejemnika [mm] 96 x 96 x 27.



Koda	Naziv	Cena
<b>ESIMPLE230W</b>	Žični nadometni regulator temperature z gumbom, 230V bel	<b>29,89</b>
<b>ESIMPLE230B</b>	Žični nadometni regulator temperature z gumbom, 230V črn	<b>29,89</b>

ESIMPLE230B je namenjen za krmiljenje površinskega ogrevanja/hlajenja, za katerega je značilna visoka toplotna vztrajnost. Nastavitve temperature v prostoru se izvaja z zasučnim gumbom. S svojim vgrajenim algoritmom nudi veliko boljše natančnost uravnavanja temperature kot tradicionalni mehanski termostati. Enostraven regulator z zasučnim gumbom, preklopno stikalo GRETJE/HLAJENJE skrito pod zasučnim gumbom, nadomestna namestitve, algoritem TPI, ki je idealen za talno ogrevanje, dvobarvna dioda LED. Napajanje: 230V AC 50Hz. Največja obremenitev: 3 (1) A. Razpon nastavitve temp.: 5 – 30°C. Krmilni algoritem: TPI ali Histereza (±0.5°C). Komunikacija: Žična. Krmilni izhod: 230V AC. Razred zaščite: IP30. Dimenzije [mm]: 80 x 80 x 26mm.

## TERMOSTATI

Koda	Naziv	Cena
<b>EASY230W</b>	Žični sobni bistabilni termostat EASY230W bel	<b>41,48</b>
<b>EASY230B*</b>	Žični sobni bistabilni termostat EASY230B črn	<b>41,48</b>



Žični dnevni termostat z omrežnim (230V) napajanjem za upravljanje naprav in ogrevalnih / hladilnih sistemov. Minimalističen dizajn, breznapetostni kontakt, žična komunikacija, zelo enostavna uporaba, LCD zaslon, programska sprememba vrste releja, funkcija zaklenitve tipk, možnost nastavitve min./maks, temperature. V kompletu element za obešanje na steno. Krmiljenje talnega ogrevanja ali krmiljenje vira ogrevanja. Natančen algoritem uravnavanja temperature TPI, preklopno stikalo OGREVANJE/PRIPRAVLJENOST/HLAJENJE. Napajanje: 230V. Največja obremenitev: 3 (1) A. Razpon nastavitve temp.: 5 – 35°C. Točnost: 0.1°C. Krmilni algoritem: TPI ali Histereza ( $\pm 0.2^{\circ}\text{C}$  do  $\pm 2^{\circ}\text{C}$ ). Komunikacija: Žična. Krmilni izhod: NO/COM (breznapetostni). Razred zaščite: IP30. Dimenzije [mm]: 80 x 80 x 22mm.

Koda	Naziv	Cena
<b>EASYBATW*</b>	Žični sobni bistabilni termostat EASYBATB bel, baterijsko napaja	<b>42,70</b>
<b>EASYBATB*</b>	Žični sobni bistabilni termostat EASYBATB črn, baterijsko napaja	<b>42,70</b>



Žični dnevni termostat z baterijskim napajanjem za upravljanje naprav in ogrevalnih / hladilnih sistemov. Minimalističen dizajn, breznapetostni kontakt, žična komunikacija, zelo enostavna uporaba, LCD zaslon, programska sprememba vrste releja, funkcija zaklenitve tipk, možnost nastavitve min./maks, temperature. V kompletu element za obešanje na steno. Krmiljenje talnega ogrevanja ali krmiljenje vira ogrevanja. Natančen algoritem uravnavanja temperature TPI, preklopno stikalo OGREVANJE/PRIPRAVLJENOST/HLAJENJE. Napajanje: bateriji 2 x AAA. Največja obremenitev: 3 (1) A. Razpon nastavitve temp.: 5 – 35°C. Točnost: 0.1°C. Krmilni algoritem: TPI ali Histereza ( $\pm 0.2^{\circ}\text{C}$  do  $\pm 2^{\circ}\text{C}$ ). Komunikacija: Žična. Krmilni izhod: NO/COM (breznapetostni). Razred zaščite: IP30. Dimenzije [mm]: 80 x 80 x 22mm.

Koda	Naziv	Cena
<b>ECB08M230*</b>	Žična centrala do 8 con upravljanja, 230V	<b>103,70</b>



Centralna letev je namenjena upravljanju površinskega ogrevanja (8 con). Omogoča udoben priklop žičnih termostatov in pogonov. Opremljena je z vgrajenim modulom za krmiljenje grelne naprave (breznapetostni kontakt). ECB08M230 upravlja temperaturo v prostorih z zapiranjem ali odpiranjem pretoka skozi ogrevalne zanke. To lahko stori s pomočjo termoelektričnih pogonov, ki se namestijo na razdelilniku. Napetostni izhod za upravljanje obtočne črpalke, 2 namenska izhoda za pogone za vsako izmed 8 con, primerna za montažo na releju DIN, sodeluje z bistabilnimi termostati ali termostati z izhodom 230V AC, vgrajena funkcija poznejšega vklopa črpalke in kotla - 3 min. Napajanje: 230V AC 50Hz. Največja obremenitev: 6(1)A. Izhodi: črpalka (230V), kotel (NO/COM/NC), termoelektrični pogon (230 V). Dimenzije [mm] 330 x 110 x 36.

Koda	Naziv	Cena
<b>E30NC230</b>	Pogon / aktuator, normalno zaprt NC, M30 x 1,5; 230V	<b>20,74</b>



Termoelektrični pogon je namenjen upravljanju ogrevalnega sistema. Pogon lahko uporabite npr. z ventilkimi vložki v razdelilniku za talno ogrevanje ali z conskimi ventili. Omogoča odpiranje oz. zapiranje pretoka ogrevalnega medija skozi zanko in s tem nadzor nad temperaturo. Sodeluje s termostatom neposredno oz. posredno preko krmilne letve. Verzija: NC = navadno zaprt. Velikost navoja: M30 x 1.5mm. Napajanje 230V AC 50Hz. Poraba moči 2W. Tok 300mA / 200ms. Moč pritiska 100N +/- 15%. Max. Skok 4.5 mm. Temperatura shranjevanja. od -25°C do +60°C. Temp. okolja: Max. 60°C. Stopnja zaščite IP 54/II. Dolžina kabla 90 cm. Dimenzije [mm]  $\Phi$  41 x 65.

## SOBNI ANALOGNI TERMOSTAT ZA GRETJE



Koda	EAN	Cena
<b>TH-1149MSA</b>	*odprodaja	<b>19,89</b>

Poraba energije: 5A. Temp. območje zaslona: -10°C~50°C. Diferenca prikaza temperature: 0.1°C. Temperaturno območje regulacije: Diferenca za nastavitev temperature: 1°C. Diferenca za preklop (histereza): 1.3°C (pri 20°C). Izbira stopnje cikla: 3, 6, 9, ali 12 na uro. Proti zamrzovalna zaščita: 5°C. Senzor temperature: NTC 10K Ohm @ 25°C. Pritrdilni set.

## SOBNI DIGITALNI TERMOSTAT ZA GRETJE



Koda	EAN	Cena
<b>TH-1149SA</b>	*odprodaja	<b>39,04</b>

Napajanje: 2x AA bateriji. Poraba energije: 5A. Zamenjava baterije enkrat letno. Temp. območje zaslona: -10°C~50°C. Diferenca prikaza temperature: 0.1°C. Temperaturno območje regulacije: 5°C~35°C. Diferenca za nastavitev temperature: 1°C. Diferenca za preklop (histereza): 0.4°C~1.0°C (privzeto 0.6°C). Izbira stopnje cikla: 3, 6, 9, ali 12 na uro. Proti zamrzovalna zaščita: 5°C. Senzor temperature: NTC 10K Ohm @ 25°C. Pritrdilni set.

## SOBNI ANALOGNI TERMOSTAT ZA GRETJE IN HLAJENJE



Koda	EAN	Cena
<b>TH-1149MSB</b>	*odprodaja	<b>28,79</b>

Poraba energije: 5A. Temp. območje zaslona: -10°C~50°C. Diferenca prikaza temperature: 0.1°C. Temperaturno območje regulacije: Diferenca za nastavitev temperature: 1°C. Diferenca za preklop (histereza): 1.3°C (pri 20°C). Izbira stopnje cikla: 3, 6, 9, ali 12 na uro. Proti zamrzovalna zaščita: 5°C. Senzor temperature: NTC 10K Ohm @ 25°C. Pritrdilni set.

## SOBNI DIGITALNI TERMOSTAT ZA GRETJE IN HLAJENJE



Koda	EAN	Cena
<b>TH-1149SB</b>	*odprodaja	<b>43,92</b>

Napajanje: 2x AA bateriji. Poraba energije: 5A. Zamenjava baterije enkrat letno. Temp. območje zaslona: -10°C~50°C. Diferenca prikaza temperature: 0.1°C. Temperaturno območje regulacije: 5°C~35°C. Diferenca za nastavitev temperature: 1°C. Diferenca za preklop (histereza): 0.4°C~1.0°C (privzeto 0.6°C). Izbira stopnje cikla: 3, 6, 9, ali 12 na uro. Proti zamrzovalna zaščita: 5°C. Senzor temperature: NTC 10K Ohm @ 25°C. Pritrdilni set.

## SOLARNI REGULATOR - 2 tipali



Koda	EAN	Cena
<b>TH-813</b>		<b>79,06</b>

Regulator za ogrevanje s sončnimi kolektorji, 4 hidravlične sheme.

## PODOMETNI NAPAVALNIK



Koda	EAN	Cena
<b>AD05-KU68</b>	8594012229891	<b>29,04</b>

Adapter 230V AC/our 5V DC 2,5A.

## TIPALO ZA SOLARNI REGULATOR



Koda	EAN	Cena
<b>103AT</b>		<b>9,76</b>

Tipalo za solarni regulator Frontier, dolžina 2m.

## SOBNI DIGITALNI TERMOSTAT S TEDENSKO NASTAVITVIJO



Koda	EAN	Cena
<b>PT22</b>	8594012224322	<b>68,93</b>

Sobni stenski digitalni termostat s tedensko nastavitvijo. Za vse vrste kotlov, 6 dnevni sprememb temperature.

## SOBNI DIGITALNI TERMOSTAT Z GSM POVEZAVO



Koda	EAN	Cena
<b>PT32GST</b>	8594012224360	<b>241,56</b>

Brezžični sobni daljinski termostat z GSM/GPRS povezavo za centralno ogrevanje, 6 dnevni sprememb temperature, avtomatska sprememba letni-zimski čas, možnost priključitve zunanega temperaturnega tipala. Napajanje: priložene baterije

## BREŽIČNI SOBNI DIGITALNI TERMOSTAT



Koda	EAN	Cena
<b>BPT22*</b>	8594012224339	<b>168,97</b>

Brezžični sobni digitalni termostat s tedensko nastavitvijo, 6 dnevni sprememb temperature, doseg 35m. Napajanje: priložene baterije

\*odprodaja

## SOBNI STENSKI DIGITALNI TERMOSTAT



Koda	EAN	Cena
<b>PT23</b>	8594012220416	<b>82,47</b>

Sobni stenski digitalni termostat s tedensko nastavitvijo, 6 sprememb temperature, za vse vrste kotlov samodejni prekolop letni/zimski čas, opozorilo ob izpraznjenih baterijah (2x1,5V AA), temp. območje 5-39°C, varovanje proti zmrzali,

## TERMOSTIKALNA VTIČNICA (z nočnim znižanjem)



Koda	EAN	Cena
<b>TS01</b>	8594012229853	<b>25,90</b>

Elektronska termostikalna vtičnica s funkcijo nočnega znižanja temperature, nastavitev od 11-28°C, z enim pritiskom gumba znižanje za 3 stopinje, zaščita proti zmrzovanju. Napajanje 230V/50Hz.

\*Po naročilu



## PLOŠČATI KOLEKTOR EM1V/2.0S Al-Cu

Koda	Naziv	Cena
<b>1022-ENSOL</b>	Ploščati kolektor EM1V/2.0S Al-Cu	<b>553,29</b>

## PRIKLJUČNI SET za kolektor

Koda	Naziv	Cena
<b>3201*</b>	Povezovalni set za 1 kolektor EM1V/2.0	<b>36,72</b>
<b>3202</b>	Povezovalni set za 2 kolektorja EM1V/2.0	<b>83,16</b>
<b>3203</b>	Povezovalni set za 3 kolektorje EM1V/2.0	<b>127,86</b>

## PRITRDILNA KONSTRUKCIJA

Koda	Naziv	Cena
<b>2001-EN*</b>	Pritrdilna konstrukcija za 1 kolektor	<b>120,00</b>
<b>EN2002</b>	Pritrdilna konstrukcija za 2 kolektorja	<b>203,37</b>
<b>EN2003</b>	Pritrdilna konstrukcija za 3 kolektorje	<b>295,97</b>

## ALVEOFLEX SOLAR SOLO - ENOJNA CEV

Koda	Naziv	Dolžina (m)	Cena / m
<b>01161350/M</b>	Flexibilna cev za sončne kolektorje enojna DN16	50 m	<b>20,01</b>
<b>01201350/M</b>	Flexibilna cev za sončne kolektorje enojna DN20	50 m	<b>23,30</b>

## ALVEOFLEX SOLAR DUO - DVOJNA CEV S KABLLOM

Koda	Naziv	V kolutu (m)	Cena / m
<b>02161350/M</b>	Flexibilna cev za sončne kolektorje dvojna DN16	50	<b>35,14</b>
<b>02201350/M</b>	Flexibilna cev za sončne kolektorje dvojna DN20	50	<b>40,75</b>

Koda	Naziv	Dimenzija	Cena
<b>342686</b>	Spojka s tesnilom kpl	DN 16	<b>23,91</b>
<b>342723</b>	Spojka s tesnilom kpl	DN 20	<b>26,60</b>

<b>V34</b>	Nipel	3/4"	<b>8,11</b>
<b>V1</b>	Nipel	1"	<b>13,08</b>

<b>PM16</b>	Matica NN	DN 16 (3/4")	<b>3,72</b>
<b>PM20</b>	Matica NN	DN 20 (1")	<b>5,19</b>

<b>DK16</b>	Ojačevalnik spoja	DN 16	<b>1,12</b>
<b>DK20</b>	Ojačevalnik spoja	DN 20	<b>1,49</b>

<b>T34</b>	Tesnilo za nipel	DN 16	<b>0,37</b>
<b>T01</b>	Tesnilo za nipel	DN 20	<b>0,39</b>



## TIP 10

## TIP 11

Po naročilu



Režim ogrevanja 20°C:  
t1=75°C, t2=65°C



dolžina (mm)	višina (mm)							višina (mm)						
	200	300	400	500	600	700	900	200	300	400	500	600	700	900
<b>400</b>				<b>55,27</b>	<b>55,27</b>	<b>66,73</b>	<b>76,13</b>		<b>77,23</b>	<b>80,52</b>	<b>91,87</b>	<b>96,01</b>	<b>113,58</b>	<b>119,68</b>
W				206	242	278	350		220	283	343	401	456	558
<b>500</b>		<b>58,07</b>	<b>56,61</b>	<b>61,00</b>	<b>62,22</b>	<b>75,88</b>	<b>86,99</b>		<b>88,69</b>	<b>89,55</b>	<b>101,87</b>	<b>105,90</b>	<b>126,64</b>	<b>138,35</b>
W		165	212	257	302	347	438		275	354	429	501	570	697
<b>600</b>		<b>61,85</b>	<b>67,71</b>	<b>67,95</b>	<b>71,00</b>	<b>86,62</b>	<b>98,70</b>		<b>96,75</b>	<b>98,45</b>	<b>111,39</b>	<b>117,24</b>	<b>141,76</b>	<b>156,53</b>
W		198	254	308	362	416	525		329	424	515	601	683	836
<b>700</b>				<b>75,03</b>	<b>78,32</b>	<b>95,53</b>	<b>108,95</b>		<b>104,80</b>	<b>108,09</b>	<b>121,15</b>	<b>128,47</b>	<b>156,89</b>	<b>174,46</b>
W				360	423	486	613		384	496	601	701	797	976
<b>800</b>				<b>81,01</b>	<b>86,99</b>	<b>105,90</b>	<b>120,54</b>		<b>113,95</b>	<b>117,36</b>	<b>132,25</b>	<b>139,32</b>	<b>172,39</b>	<b>193,13</b>
W				411	483	555	700		439	566	686	802	911	1115
<b>900</b>				<b>88,08</b>	<b>95,40</b>	<b>116,14</b>	<b>132,25</b>		<b>122,12</b>	<b>129,08</b>	<b>140,42</b>	<b>150,55</b>	<b>187,27</b>	<b>211,06</b>
W				463	544	625	788		494	637	772	902	1025	1255
<b>1000</b>				<b>93,94</b>	<b>104,19</b>	<b>126,64</b>	<b>143,59</b>		<b>129,08</b>	<b>140,42</b>	<b>151,52</b>	<b>163,36</b>	<b>203,62</b>	<b>229,24</b>
W				514	604	694	875		549	708	858	1002	1139	1394
<b>1100</b>				<b>104,19</b>	<b>112,61</b>	<b>136,15</b>	<b>155,06</b>		<b>139,93</b>	<b>153,96</b>	<b>162,63</b>	<b>176,05</b>	<b>218,50</b>	<b>247,78</b>
W				565	664	763	963		604	779	944	1102	1253	1533
<b>1200</b>				<b>112,61</b>	<b>121,51</b>	<b>148,11</b>	<b>166,65</b>		<b>151,16</b>	<b>167,51</b>	<b>172,39</b>	<b>188,73</b>	<b>235,34</b>	<b>267,55</b>
W				617	725	833	1050		659	850	1030	1202	1367	1673
<b>1400</b>				<b>128,47</b>	<b>141,52</b>	<b>169,09</b>	<b>190,08</b>		<b>170,68</b>	<b>194,96</b>	<b>193,13</b>	<b>214,11</b>	<b>268,40</b>	<b>305,24</b>
W				720	846	972	1225		769	991	1201	1403	1595	1952
<b>1600</b>				<b>145,67</b>	<b>158,60</b>	<b>190,08</b>	<b>212,89</b>		<b>190,32</b>	<b>222,53</b>	<b>213,87</b>	<b>240,83</b>	<b>300,97</b>	<b>341,72</b>
W				822	966	1110	1400		878	1133	1373	1603	1822	2230
<b>1800</b>				<b>163,11</b>	<b>178,61</b>	<b>212,77</b>		<b>211,43</b>	<b>250,22</b>	<b>235,95</b>	<b>267,55</b>	<b>334,40</b>		
W				925	1087	1249		988	1274	1544	1804	2050		
<b>2000</b>				<b>180,19</b>	<b>195,81</b>	<b>233,87</b>		<b>231,92</b>	<b>277,55</b>	<b>256,69</b>	<b>292,43</b>	<b>365,63</b>		
W				1028	1208	1388		1098	1416	1716	2004	2278		
<b>2300</b>										<b>288,65</b>	<b>331,84</b>	<b>413,70</b>		
W										1973	2305	2620		
<b>2600</b>										<b>319,15</b>	<b>371,25</b>	<b>463,72</b>		
W										2231	2605	2961		
<b>3000</b>										<b>361,85</b>	<b>423,10</b>	<b>527,89</b>		
W										2574	3006	3417		

## TIP 20

## TIP 21

Po naročilu



Režim ogrevanja 20°C:  
t1=75°C, t2=65°C



dolžina (mm)	višina (mm)							višina (mm)						
	200	300	400	500	600	700	900	200	300	400	500	600	700	900
<b>400</b>				<b>90,28</b>	<b>108,09</b>	<b>125,54</b>		<b>103,33</b>	<b>106,63</b>	<b>104,43</b>	<b>122,24</b>	<b>146,89</b>	<b>161,41</b>	
W				335	391	447		298	375	447	515	580	702	
<b>500</b>				<b>104,80</b>	<b>122,61</b>	<b>143,59</b>		<b>109,19</b>	<b>119,56</b>	<b>119,80</b>	<b>139,32</b>	<b>167,26</b>	<b>187,03</b>	
W				419	489	559		373	469	559	644	725	877	
<b>600</b>				<b>118,10</b>	<b>138,84</b>	<b>161,89</b>		<b>115,29</b>	<b>126,88</b>	<b>135,66</b>	<b>156,53</b>	<b>190,08</b>	<b>212,77</b>	
W				503	587	670		447	562	670	773	870	1052	
<b>700</b>				<b>131,15</b>	<b>153,48</b>	<b>179,71</b>		<b>121,39</b>	<b>134,32</b>	<b>151,77</b>	<b>173,61</b>	<b>211,06</b>	<b>238,14</b>	
W				587	685	782		522	656	782	902	1015	1228	
<b>800</b>				<b>146,03</b>	<b>168,12</b>	<b>197,88</b>		<b>126,88</b>	<b>141,64</b>	<b>167,14</b>	<b>190,32</b>	<b>231,92</b>	<b>264,01</b>	
W				670	782	894		596	750	894	1030	1160	1403	
<b>900</b>				<b>160,67</b>	<b>182,76</b>	<b>215,45</b>		<b>138,84</b>	<b>154,57</b>	<b>182,76</b>	<b>207,64</b>	<b>253,15</b>	<b>288,04</b>	
W				754	880	1005		671	843	1005	1159	1305	1579	
<b>1000</b>				<b>173,85</b>	<b>197,27</b>	<b>233,87</b>		<b>150,43</b>	<b>166,65</b>	<b>198,74</b>	<b>224,60</b>	<b>274,38</b>	<b>312,44</b>	
W				838	978	1117		745	937	1117	1288	1450	1754	
<b>1100</b>				<b>188,61</b>	<b>213,87</b>	<b>251,44</b>		<b>165,19</b>	<b>184,34</b>	<b>215,45</b>	<b>242,78</b>	<b>296,95</b>	<b>337,70</b>	
W				922	1076	1229		820	1031	1229	1417	1595	1929	
<b>1200</b>				<b>203,37</b>	<b>229,85</b>	<b>271,57</b>		<b>184,34</b>	<b>204,96</b>	<b>231,31</b>	<b>261,45</b>	<b>319,52</b>	<b>363,56</b>	
W				1006	1174	1340		894	1124	1340	1546	1740	2105	
<b>1400</b>				<b>231,31</b>	<b>262,18</b>	<b>308,90</b>		<b>207,89</b>	<b>231,31</b>	<b>265,59</b>	<b>298,41</b>	<b>364,17</b>	<b>413,46</b>	
W				1173	1369	1564		1043	1312	1564	1803	2030	2456	
<b>1600</b>				<b>262,18</b>	<b>294,39</b>	<b>346,60</b>		<b>232,41</b>	<b>257,79</b>	<b>298,29</b>	<b>335,01</b>	<b>409,80</b>	<b>463,23</b>	
W				1341	1565	1787		1192	1499	1787	2061	2320	2806	
<b>1800</b>				<b>289,99</b>	<b>326,84</b>	<b>384,18</b>		<b>257,79</b>	<b>285,60</b>	<b>330,74</b>	<b>370,64</b>	<b>453,23</b>	<b>514,35</b>	
W				1508	1760	2011		1341	1687	2011	2318	2610	3157	
<b>2000</b>				<b>319,52</b>	<b>359,05</b>	<b>421,51</b>		<b>284,02</b>	<b>314,88</b>	<b>365,02</b>	<b>408,70</b>	<b>499,96</b>	<b>565,84</b>	
W				1676	1956	2234		1490	1874	2234	2576	2900	3508	
<b>2300</b>				<b>348,68</b>	<b>390,03</b>	<b>468,11</b>				<b>412,12</b>	<b>461,16</b>	<b>564,25</b>		
W				1927	2249	2569				2569	2962	3335		
<b>2600</b>				<b>378,08</b>	<b>422,36</b>	<b>512,89</b>				<b>459,33</b>	<b>513,74</b>	<b>628,91</b>		
W				2179	2543	2904				2904	3349	3770		
<b>3000</b>				<b>407,72</b>	<b>453,23</b>	<b>569,01</b>				<b>523,14</b>	<b>582,92</b>	<b>716,02</b>		
W				2514	2934	3351				3351	3864	4350		

TIP 22

TIP 33



Režim ogrevanja 20°C:  
t1=75°C, t2=65°C



dolžina (mm)	višina (mm)							višina (mm)						
	200	300	400	500	600	700	900	200	300	400	500	600	700	900
<b>400</b>	<b>117,00</b>	<b>125,78</b>	<b>119,32</b>	<b>138,84</b>	<b>163,24</b>	<b>175,19</b>		<b>162,99</b>	<b>168,85</b>	<b>196,79</b>	<b>215,09</b>	<b>257,79</b>	<b>279,14</b>	
W	386	486	581	672	759	925		552	695	832	962	1089	1331	
<b>500</b>	<b>129,69</b>	<b>140,42</b>	<b>137,49</b>	<b>156,77</b>	<b>190,08</b>	<b>210,45</b>		<b>181,90</b>	<b>190,32</b>	<b>223,75</b>	<b>239,24</b>	<b>290,48</b>	<b>322,32</b>	
W	483	608	726	840	949	1157		690	869	1040	1203	1362	1664	
<b>600</b>	<b>140,54</b>	<b>154,21</b>	<b>155,43</b>	<b>174,09</b>	<b>217,04</b>	<b>245,71</b>		<b>201,18</b>	<b>212,89</b>	<b>244,24</b>	<b>261,69</b>	<b>325,62</b>	<b>365,27</b>	
W	580	730	871	1007	1138	1388		827	1043	1247	1444	1634	1997	
<b>700</b>	<b>152,26</b>	<b>168,36</b>	<b>173,12</b>	<b>193,00</b>	<b>244,24</b>	<b>279,01</b>		<b>218,38</b>	<b>234,85</b>	<b>265,72</b>	<b>288,77</b>	<b>358,44</b>	<b>408,58</b>	
W	676	851	1016	1175	1328	1619		965	1217	1455	1684	1906	2330	
<b>800</b>	<b>160,06</b>	<b>164,94</b>	<b>181,90</b>	<b>191,42</b>	<b>210,45</b>	<b>271,57</b>	<b>313,66</b>	<b>220,33</b>	<b>235,95</b>	<b>257,18</b>	<b>287,43</b>	<b>310,98</b>	<b>391,50</b>	<b>451,64</b>
W	519	773	973	1162	1343	1518	1850	747	1103	1390	1663	1925	2178	2662
<b>900</b>	<b>172,39</b>	<b>174,09</b>	<b>197,88</b>	<b>209,60</b>	<b>229,12</b>	<b>296,95</b>	<b>352,21</b>	<b>238,39</b>	<b>254,86</b>	<b>279,01</b>	<b>309,15</b>	<b>337,33</b>	<b>426,02</b>	<b>496,42</b>
W	584	869	1094	1307	1511	1707	2082	841	1241	1564	1871	2165	2451	2995
<b>1000</b>	<b>184,22</b>	<b>188,61</b>	<b>211,43</b>	<b>227,53</b>	<b>244,37</b>	<b>325,62</b>	<b>387,84</b>	<b>255,96</b>	<b>272,79</b>	<b>300,85</b>	<b>330,74</b>	<b>360,88</b>	<b>457,50</b>	<b>538,14</b>
W	649	966	1216	1452	1679	1897	2313	934	1379	1738	2079	2406	2723	3328
<b>1100</b>	<b>197,88</b>	<b>201,91</b>	<b>227,77</b>	<b>246,56</b>	<b>268,89</b>	<b>352,21</b>	<b>417,12</b>	<b>272,67</b>	<b>292,19</b>	<b>322,57</b>	<b>356,97</b>	<b>390,64</b>	<b>495,20</b>	<b>579,62</b>
W	714	1063	1338	1597	1847	2087	2544	1027	1517	1912	2287	2647	2995	3661
<b>1200</b>	<b>209,72</b>	<b>215,09</b>	<b>243,88</b>	<b>265,72</b>	<b>293,29</b>	<b>379,54</b>	<b>446,15</b>	<b>290,48</b>	<b>310,98</b>	<b>344,16</b>	<b>383,32</b>	<b>419,80</b>	<b>529,72</b>	<b>619,64</b>
W	779	1159	1459	1742	2015	2276	2776	1121	1655	2086	2495	2887	3268	3994
<b>1400</b>	<b>233,87</b>	<b>240,83</b>	<b>274,26</b>	<b>304,27</b>	<b>339,89</b>	<b>435,30</b>	<b>500,44</b>	<b>325,62</b>	<b>349,04</b>	<b>388,69</b>	<b>435,54</b>	<b>477,14</b>	<b>600,24</b>	<b>701,87</b>
W	909	1352	1702	2033	2351	2656	3238	1308	1931	2433	2911	3368	3812	4659
<b>1600</b>	<b>259,25</b>	<b>266,33</b>	<b>306,46</b>	<b>342,09</b>	<b>386,13</b>	<b>488,98</b>	<b>558,52</b>	<b>360,27</b>	<b>386,74</b>	<b>431,76</b>	<b>486,54</b>	<b>535,58</b>	<b>672,71</b>	<b>802,15</b>
W	1038	1546	1946	2323	2686	3035	3701	1494	2206	2781	3326	3850	4357	5325
<b>1800</b>	<b>283,28</b>	<b>290,97</b>	<b>340,75</b>	<b>380,52</b>	<b>433,22</b>	<b>553,51</b>	<b>661,61</b>	<b>396,26</b>	<b>424,93</b>	<b>476,78</b>	<b>538,39</b>	<b>593,41</b>	<b>747,86</b>	<b>893,28</b>
W	1168	1739	2189	2614	3022	3415	4163	1681	2482	3128	3742	4331	4901	5990
<b>2000</b>	<b>308,90</b>	<b>316,59</b>	<b>372,22</b>	<b>419,07</b>	<b>479,70</b>	<b>612,32</b>	<b>730,05</b>	<b>430,66</b>	<b>462,87</b>	<b>519,35</b>	<b>590,85</b>	<b>650,02</b>	<b>819,60</b>	<b>979,90</b>
W	1298	1932	2432	2904	3358	3794	4626	1868	2758	3476	4158	4812	5446	6656
<b>2300</b>	<b>344,77</b>	<b>360,39</b>	<b>420,05</b>	<b>476,04</b>	<b>549,37</b>	<b>699,55</b>		<b>483,24</b>	<b>519,96</b>	<b>585,60</b>	<b>669,78</b>	<b>769,82</b>	<b>924,64</b>	
W	1493	2222	2797	3340	3862	4363		2148	3172	3997	4782	5534	6263	
<b>2600</b>	<b>382,35</b>	<b>398,33</b>	<b>469,33</b>	<b>533,75</b>	<b>619,64</b>	<b>786,41</b>		<b>535,70</b>	<b>576,45</b>	<b>650,02</b>	<b>735,78</b>	<b>844,48</b>	<b>1.024,19</b>	
W	1687	2512	3162	3775	4365	4932		2428	3585	4519	5405	6256	7080	
<b>3000</b>	<b>432,12</b>	<b>440,54</b>	<b>533,38</b>	<b>610,24</b>	<b>719,43</b>	<b>904,14</b>		<b>604,63</b>	<b>653,07</b>	<b>738,34</b>	<b>825,70</b>	<b>947,82</b>	<b>1.157,90</b>	
W	1947	2898	3648	4356	5037	5691		2802	4137	5214	6237	7218	8169	

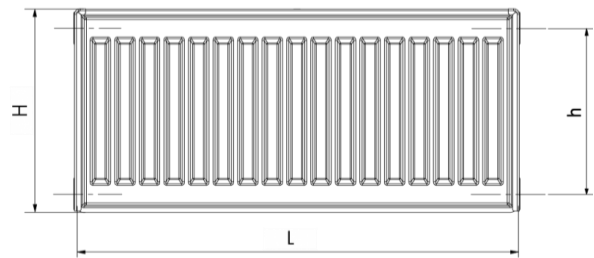

**BARVNA LESTVICA:** Standardna površinska barva radiatorjev je bela RAL 9016. Dopolnilo 30% za drugo barvo s KORADO barvne lestvice (glej www.korado.si). Dopolnilo 40% za drugo barvo z RAL lestvice.

SATIN GLOSS



HIGH GLOSS



MATTE



DEEP MATTE



TIP 10								TIP 11							
Po naročilu						Režim ogrevanja 20°C: t1=75°C, t2=65°C									
dolžina (mm)	višina (mm)							višina (mm)							
	200	300	400	500	600	700	900	200	300	400	500	600	700	900	
<b>400</b>				<b>113,58</b>	<b>113,58</b>	<b>136,76</b>	<b>133,10</b>		<b>131,88</b>	<b>134,93</b>	<b>151,89</b>	<b>154,94</b>	<b>179,58</b>	<b>175,68</b>	
W				206	242	278	350		220	283	343	401	456	558	
<b>500</b>	<b>118,46</b>	<b>121,51</b>	<b>118,46</b>	<b>118,46</b>	<b>144,94</b>	<b>143,59</b>		<b>147,74</b>	<b>145,06</b>	<b>160,67</b>	<b>164,46</b>	<b>193,37</b>	<b>193,13</b>		
W	165	212	257	302	347	438		275	354	429	501	570	697		
<b>600</b>	<b>123,95</b>	<b>125,29</b>	<b>125,29</b>	<b>126,03</b>	<b>154,94</b>	<b>153,35</b>		<b>155,43</b>	<b>156,28</b>	<b>169,21</b>	<b>174,09</b>	<b>207,64</b>	<b>211,06</b>		
W	198	254	308	362	416	525		329	424	515	601	683	836		
<b>700</b>			<b>130,17</b>	<b>133,10</b>	<b>163,11</b>	<b>163,36</b>		<b>163,11</b>	<b>166,77</b>	<b>179,83</b>	<b>186,78</b>	<b>223,75</b>	<b>228,02</b>		
W			360	423	486	613		384	496	601	701	797	976		
<b>800</b>			<b>135,66</b>	<b>140,54</b>	<b>175,19</b>	<b>173,97</b>		<b>170,56</b>	<b>177,75</b>	<b>188,61</b>	<b>196,54</b>	<b>238,14</b>	<b>244,37</b>		
W			411	483	555	700		439	566	686	802	911	1115		
<b>900</b>			<b>142,13</b>	<b>147,74</b>	<b>183,37</b>	<b>187,03</b>		<b>178,36</b>	<b>186,78</b>	<b>204,96</b>	<b>206,42</b>	<b>252,42</b>	<b>261,57</b>		
W			463	544	625	788		494	637	772	902	1025	1255		
<b>1000</b>			<b>147,74</b>	<b>156,28</b>	<b>193,37</b>	<b>194,83</b>		<b>184,95</b>	<b>198,01</b>	<b>207,64</b>	<b>217,89</b>	<b>268,52</b>	<b>278,40</b>		
W			514	604	694	875		549	708	858	1002	1139	1394		
<b>1100</b>			<b>155,79</b>	<b>164,21</b>	<b>203,62</b>	<b>205,33</b>		<b>194,83</b>	<b>210,57</b>	<b>217,28</b>	<b>230,58</b>	<b>282,92</b>	<b>295,97</b>		
W			565	664	763	963		604	779	944	1102	1253	1533		
<b>1200</b>			<b>163,36</b>	<b>171,65</b>	<b>214,11</b>	<b>215,09</b>		<b>204,96</b>	<b>223,38</b>	<b>227,04</b>	<b>242,66</b>	<b>298,66</b>	<b>313,30</b>		
W			617	725	833	1050		659	850	1030	1202	1367	1673		
<b>1400</b>			<b>177,75</b>	<b>187,88</b>	<b>234,00</b>	<b>236,07</b>		<b>223,38</b>	<b>248,64</b>	<b>253,76</b>	<b>265,96</b>	<b>330,99</b>	<b>348,68</b>		
W			720	846	972	1225		769	991	1201	1403	1595	1952		
<b>1600</b>			<b>193,13</b>	<b>204,11</b>	<b>254,61</b>	<b>258,15</b>		<b>242,78</b>	<b>276,21</b>	<b>279,14</b>	<b>289,87</b>	<b>361,85</b>	<b>382,23</b>		
W			822	966	1110	1400		878	1133	1373	1603	1822	2230		
<b>1800</b>			<b>208,62</b>	<b>221,43</b>	<b>276,57</b>			<b>261,57</b>	<b>302,68</b>	<b>307,44</b>	<b>314,15</b>	<b>392,47</b>			
W			925	1087	1249			988	1274	1544	1804	2050			
<b>2000</b>			<b>223,38</b>	<b>238,02</b>	<b>296,95</b>			<b>281,09</b>	<b>326,72</b>	<b>333,18</b>	<b>338,92</b>	<b>424,93</b>			
W			1028	1208	1388			1098	1416	1716	2004	2278			
<b>2300</b>										<b>345,87</b>	<b>375,76</b>	<b>453,84</b>			
W										1973	2305	2620			
<b>2600</b>										<b>373,44</b>	<b>411,63</b>	<b>518,13</b>			
W										2231	2605	2961			
<b>3000</b>										<b>411,26</b>	<b>460,06</b>	<b>578,89</b>			
W										2574	3006	3417			

TIP 20								TIP 21							
						Režim ogrevanja 20°C: t1=75°C, t2=65°C									
dolžina (mm)	višina (mm)							višina (mm)							
	200	300	400	500	600	700	900	200	300	400	500	600	700	900	
<b>400</b>				<b>153,72</b>	<b>167,26</b>	<b>191,17</b>			<b>150,06</b>	<b>163,36</b>	<b>166,29</b>	<b>183,37</b>	<b>214,11</b>	<b>221,67</b>	
W				335	391	447			298	375	447	515	580	702	
<b>500</b>				<b>167,26</b>	<b>182,76</b>	<b>209,72</b>			<b>163,36</b>	<b>180,44</b>	<b>180,56</b>	<b>199,23</b>	<b>234,00</b>	<b>244,98</b>	
W				419	489	559			373	469	559	644	725	877	
<b>600</b>				<b>180,80</b>	<b>196,54</b>	<b>225,58</b>			<b>182,51</b>	<b>192,27</b>	<b>195,20</b>	<b>214,96</b>	<b>254,61</b>	<b>268,89</b>	
W				503	587	670			447	562	670	773	870	1052	
<b>700</b>				<b>192,64</b>	<b>212,04</b>	<b>244,24</b>			<b>188,37</b>	<b>205,57</b>	<b>210,45</b>	<b>230,95</b>	<b>274,50</b>	<b>293,29</b>	
W				587	685	782			522	656	782	902	1015	1228	
<b>800</b>				<b>206,18</b>	<b>225,46</b>	<b>260,35</b>			<b>206,42</b>	<b>210,57</b>	<b>224,72</b>	<b>247,78</b>	<b>294,75</b>	<b>316,10</b>	
W				670	782	894			596	750	894	1030	1160	1403	
<b>900</b>				<b>219,84</b>	<b>238,75</b>	<b>278,89</b>			<b>217,40</b>	<b>223,14</b>	<b>239,49</b>	<b>263,89</b>	<b>315,37</b>	<b>340,14</b>	
W				754	880	1005			671	843	1005	1159	1305	1579	
<b>1000</b>				<b>233,63</b>	<b>252,54</b>	<b>296,95</b>			<b>226,55</b>	<b>233,87</b>	<b>254,86</b>	<b>279,62</b>	<b>337,45</b>	<b>363,19</b>	
W				838	978	1117			745	937	1117	1288	1450	1754	
<b>1100</b>				<b>246,81</b>	<b>270,23</b>	<b>315,37</b>			<b>239,61</b>	<b>250,22</b>	<b>272,67</b>	<b>299,51</b>	<b>357,95</b>	<b>389,79</b>	
W				922	1076	1229			820	1031	1229	1417	1595	1929	
<b>1200</b>				<b>258,64</b>	<b>283,53</b>	<b>333,30</b>			<b>253,27</b>	<b>266,33</b>	<b>290,48</b>	<b>319,40</b>	<b>379,91</b>	<b>416,75</b>	
W				1006	1174	1340			894	1124	1340	1546	1740	2105	
<b>1400</b>				<b>287,55</b>	<b>314,64</b>	<b>370,03</b>			<b>284,02</b>	<b>306,83</b>	<b>318,18</b>	<b>348,31</b>	<b>422,61</b>	<b>478,36</b>	
W				1173	1369	1564			1043	1312	1564	1803	2030	2456	
<b>1600</b>				<b>314,64</b>	<b>345,87</b>	<b>406,38</b>			<b>327,57</b>	<b>354,53</b>	<b>348,31</b>	<b>383,81</b>	<b>465,19</b>	<b>527,77</b>	
W				1341	1565	1787			1192	1499	1787	2061	2320	2806	
<b>1800</b>				<b>341,72</b>	<b>374,78</b>	<b>440,54</b>			<b>370,88</b>	<b>399,06</b>	<b>381,37</b>	<b>418,34</b>	<b>508,13</b>	<b>577,06</b>	
W				1508	1760	2011			1341	1687	2011	2318	2610	3157	
<b>2000</b>				<b>369,05</b>	<b>405,77</b>	<b>477,39</b>			<b>408,82</b>	<b>446,15</b>	<b>412,12</b>	<b>454,69</b>	<b>552,42</b>	<b>628,06</b>	
W				1676	1956	2234			1490	1874	2234	2576	2900	3508	
<b>2300</b>				<b>396,26</b>	<b>436,76</b>	<b>522,16</b>					<b>461,40</b>	<b>505,08</b>	<b>610,98</b>		
W				1927	2249	2569					2569	2962	3335		
<b>2600</b>				<b>423,34</b>	<b>467,99</b>	<b>568,52</b>					<b>507,28</b>	<b>554,73</b>	<b>674,05</b>		
W				2179	2543	2904					2904	3349	3770		
<b>3000</b>				<b>450,30</b>	<b>498,86</b>	<b>623,54</b>					<b>570,11</b>	<b>623,66</b>	<b>759,21</b>		
W				2514	2934	3351					3351	3864	4350		

TIP 22								TIP 33													
Po naročilu								Režim ogrevanja 20°C: t1=75°C, t2=65°C													
dolžina (mm)	višina (mm)							višina (mm)													
	200	300	400	500	600	700	900	200	300	400	500	600	700	900							
<b>400</b>	<b>165,43</b>	<b>190,93</b>	<b>181,41</b>	<b>195,81</b>	<b>228,02</b>	<b>236,19</b>		<b>229,12</b>	<b>235,34</b>	<b>260,59</b>	<b>281,45</b>	<b>319,40</b>	<b>336,60</b>								
W	386	486	581	672	759	925		552	695	832	962	1089	1331								
<b>500</b>	<b>175,19</b>	<b>203,98</b>	<b>198,74</b>	<b>214,84</b>	<b>254,61</b>	<b>270,72</b>		<b>247,29</b>	<b>257,18</b>	<b>285,85</b>	<b>305,37</b>	<b>351,60</b>	<b>377,96</b>								
W	483	608	726	840	949	1157		690	869	1040	1203	1362	1664								
<b>600</b>	<b>197,15</b>	<b>215,45</b>	<b>215,45</b>	<b>231,31</b>	<b>278,89</b>	<b>304,51</b>		<b>265,11</b>	<b>279,38</b>	<b>306,83</b>	<b>329,03</b>	<b>384,18</b>	<b>418,58</b>								
W	580	730	871	1007	1138	1388		827	1043	1247	1444	1634	1997								
<b>700</b>	<b>209,72</b>	<b>231,19</b>	<b>232,78</b>	<b>248,51</b>	<b>305,12</b>	<b>335,99</b>		<b>283,16</b>	<b>299,39</b>	<b>327,94</b>	<b>352,34</b>	<b>416,75</b>	<b>460,43</b>								
W	676	851	1016	1175	1328	1619		965	1217	1455	1684	1906	2330								
<b>800</b>	<b>218,62</b>	<b>224,72</b>	<b>246,20</b>	<b>250,22</b>	<b>266,45</b>	<b>333,30</b>	<b>370,03</b>	<b>288,04</b>	<b>290,24</b>	<b>308,90</b>	<b>348,31</b>	<b>387,72</b>	<b>449,20</b>	<b>501,18</b>							
W	519	773	973	1162	1343	1518	1850	747	1103	1390	1663	1925	2178	2662							
<b>900</b>	<b>231,19</b>	<b>238,14</b>	<b>257,79</b>	<b>269,25</b>	<b>283,77</b>	<b>357,95</b>	<b>403,70</b>	<b>306,59</b>	<b>306,83</b>	<b>329,64</b>	<b>370,51</b>	<b>398,33</b>	<b>481,53</b>	<b>542,29</b>							
W	584	869	1094	1307	1511	1707	2082	841	1241	1564	1871	2165	2451	2995							
<b>1000</b>	<b>245,22</b>	<b>246,32</b>	<b>272,79</b>	<b>284,50</b>	<b>300,85</b>	<b>384,18</b>	<b>437,37</b>	<b>322,93</b>	<b>323,79</b>	<b>348,31</b>	<b>391,25</b>	<b>422,73</b>	<b>513,86</b>	<b>583,89</b>							
W	649	966	1216	1452	1679	1897	2313	934	1379	1738	2079	2406	2723	3328							
<b>1100</b>	<b>257,79</b>	<b>259,98</b>	<b>288,04</b>	<b>303,17</b>	<b>322,93</b>	<b>410,41</b>	<b>464,58</b>	<b>341,23</b>	<b>341,84</b>	<b>370,03</b>	<b>416,87</b>	<b>450,67</b>	<b>548,39</b>	<b>623,18</b>							
W	714	1063	1338	1597	1847	2087	2544	1027	1517	1912	2287	2647	2995	3661							
<b>1200</b>	<b>271,94</b>	<b>274,01</b>	<b>303,17</b>	<b>322,32</b>	<b>345,14</b>	<b>436,76</b>	<b>492,03</b>	<b>357,70</b>	<b>360,39</b>	<b>391,25</b>	<b>442,25</b>	<b>478,24</b>	<b>580,72</b>	<b>661,61</b>							
W	779	1159	1459	1742	2015	2276	2776	1121	1655	2086	2495	2887	3268	3994							
<b>1400</b>	<b>298,53</b>	<b>301,71</b>	<b>333,91</b>	<b>360,51</b>	<b>389,06</b>	<b>489,71</b>	<b>548,39</b>	<b>392,47</b>	<b>411,02</b>	<b>431,64</b>	<b>505,93</b>	<b>561,32</b>	<b>650,02</b>	<b>738,71</b>							
W	909	1352	1702	2033	2351	2656	3238	1308	1931	2433	2911	3368	3812	4659							
<b>1600</b>	<b>324,76</b>	<b>326,23</b>	<b>366,00</b>	<b>396,50</b>	<b>434,44</b>	<b>544,73</b>	<b>604,63</b>	<b>428,83</b>	<b>447,13</b>	<b>471,41</b>	<b>557,54</b>	<b>621,22</b>	<b>722,85</b>	<b>867,79</b>							
W	1038	1546	1946	2323	2686	3035	3701	1494	2206	2781	3326	3850	4357	5325							
<b>1800</b>	<b>351,48</b>	<b>350,38</b>	<b>398,45</b>	<b>432,98</b>	<b>478,97</b>	<b>605,24</b>	<b>737,61</b>	<b>463,72</b>	<b>484,95</b>	<b>514,11</b>	<b>610,24</b>	<b>679,91</b>	<b>793,49</b>	<b>952,33</b>							
W	1168	1739	2189	2614	3022	3415	4163	1681	2482	3128	3742	4331	4901	5990							
<b>2000</b>	<b>377,96</b>	<b>374,05</b>	<b>429,07</b>	<b>470,92</b>	<b>522,77</b>	<b>661,61</b>	<b>804,96</b>	<b>498,13</b>	<b>521,55</b>	<b>566,08</b>	<b>662,34</b>	<b>739,20</b>	<b>863,03</b>	<b>1.037,24</b>							
W	1298	1932	2432	2904	3358	3794	4626	1868	2758	3476	4158	4812	5446	6656							
<b>2300</b>	<b>418,70</b>	<b>409,92</b>	<b>476,78</b>	<b>526,06</b>	<b>589,38</b>	<b>744,93</b>		<b>551,56</b>	<b>577,06</b>	<b>617,69</b>	<b>723,83</b>	<b>806,66</b>	<b>954,04</b>								
W	1493	2222	2797	3340	3862	4363		2148	3172	3997	4782	5534	6263								
<b>2600</b>	<b>457,50</b>	<b>446,89</b>	<b>524,36</b>	<b>581,21</b>	<b>655,63</b>	<b>830,09</b>		<b>602,44</b>	<b>633,30</b>	<b>676,49</b>	<b>796,78</b>	<b>887,55</b>	<b>1.053,47</b>								
W	1687	2512	3162	3775	4365	4932		2428	3585	4519	5405	6256	7080								
<b>3000</b>	<b>510,69</b>	<b>495,44</b>	<b>584,75</b>	<b>655,63</b>	<b>745,54</b>	<b>941,72</b>		<b>673,81</b>	<b>706,62</b>	<b>759,21</b>	<b>893,77</b>	<b>996,86</b>	<b>1.187,30</b>								
W	1947	2898	3648	4356	5037	5691		2802	4137	5214	6237	7218	8169								

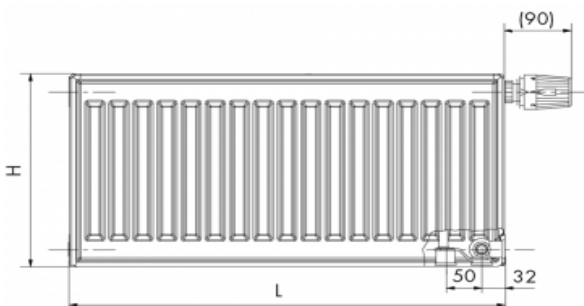

VK radiatorji imajo zadaj obešala za klasične stenske konzole (tip H).

VKU radiatorji so brez obešal, obe strani sta enaki, konzole za te radiatorje so prilagojene (tip C).

**BARVNA LESTVICA:** Standardna površinska barva radiatorjev je bela RAL 9016. Doplačilo 30% za drugo barvo s KORADO barvne lestvice (glej www.korado.si). Doplačilo 40% za drugo barvo z RAL lestvice.

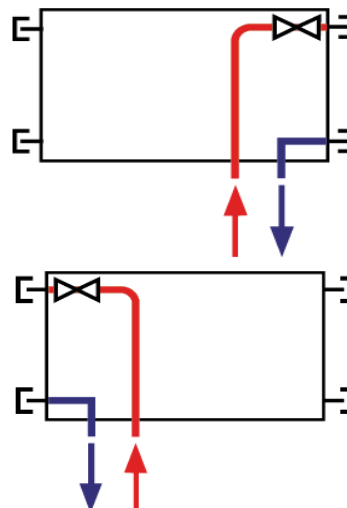

SATIN GLOSS



HIGH GLOSS



MATTE



DEEP MATTE



## TIP 10 VKM

## TIP 11 VKM

Po naročilu



Režim ogrevanja 20°C:  
t1=75°C, t2=65°C



dolžina (mm)	višina (mm)							višina (mm)									
	200	300	400	500	600	700	900	200	300	400	500	600	700	900			
<b>400</b>				<b>147,25</b>	<b>147,25</b>	<b>155,06</b>	<b>166,29</b>				<b>160,67</b>	<b>165,55</b>	<b>183,37</b>	<b>184,71</b>	<b>206,18</b>	<b>205,20</b>	
W				229	266	301	369				213	273	332	392	452	573	
<b>500</b>		<b>147,25</b>	<b>150,43</b>	<b>152,01</b>	<b>152,01</b>	<b>161,41</b>	<b>173,85</b>				<b>180,19</b>	<b>177,02</b>	<b>190,69</b>	<b>192,39</b>	<b>217,65</b>	<b>220,94</b>	
W		188	238	286	333	377	461				267	342	416	490	565	716	
<b>600</b>			<b>152,01</b>	<b>153,72</b>	<b>158,48</b>	<b>160,06</b>	<b>169,21</b>	<b>184,95</b>				<b>186,05</b>	<b>187,76</b>	<b>198,25</b>	<b>201,67</b>	<b>231,31</b>	<b>236,19</b>
W			225	286	343	399	452	553				320	410	499	587	677	859
<b>700</b>				<b>163,11</b>	<b>166,29</b>	<b>177,27</b>	<b>193,00</b>				<b>192,39</b>	<b>197,15</b>	<b>208,01</b>	<b>213,01</b>	<b>244,98</b>	<b>253,03</b>	
W				400	466	527	645				373	478	582	685	790	1002	
<b>800</b>				<b>167,51</b>	<b>172,63</b>	<b>184,95</b>	<b>203,62</b>				<b>200,08</b>	<b>206,42</b>	<b>217,65</b>	<b>222,41</b>	<b>256,81</b>	<b>266,45</b>	
W				458	532	602	738				426	546	665	783	903	1146	
<b>900</b>				<b>173,85</b>	<b>180,32</b>	<b>193,00</b>	<b>213,01</b>				<b>206,42</b>	<b>216,31</b>	<b>224,11</b>	<b>230,46</b>	<b>270,72</b>	<b>283,77</b>	
W				515	599	678	830				480	615	748	881	1016	1289	
<b>1000</b>				<b>180,32</b>	<b>186,54</b>	<b>200,69</b>	<b>222,41</b>				<b>214,84</b>	<b>224,97</b>	<b>233,63</b>	<b>241,68</b>	<b>282,19</b>	<b>298,41</b>	
W				572	665	753	922				533	683	831	979	1129	1432	
<b>1100</b>				<b>186,54</b>	<b>194,35</b>	<b>209,84</b>				<b>222,53</b>	<b>237,66</b>	<b>243,39</b>	<b>252,54</b>	<b>296,83</b>	<b>314,03</b>		
W				629	732	828				586	751	914	1077	1242	1575		
<b>1200</b>				<b>193,00</b>	<b>200,69</b>	<b>217,65</b>				<b>230,46</b>	<b>249,37</b>	<b>253,03</b>	<b>263,64</b>	<b>311,10</b>	<b>329,64</b>		
W				686	798	904				640	820	997	1175	1355	1718		
<b>1400</b>				<b>206,91</b>	<b>216,31</b>	<b>233,63</b>				<b>254,00</b>	<b>276,57</b>	<b>273,28</b>	<b>290,97</b>	<b>339,89</b>	<b>370,51</b>		
W				801	931	1054				746	956	1163	1371	1581	2005		
<b>1600</b>				<b>220,94</b>	<b>230,21</b>	<b>250,71</b>				<b>269,99</b>	<b>302,19</b>	<b>292,68</b>	<b>312,32</b>	<b>365,15</b>	<b>400,04</b>		
W				915	1064	1205				853	1093	1330	1566	1806	2291		
<b>1800</b>				<b>234,85</b>	<b>247,42</b>	<b>267,67</b>				<b>289,51</b>	<b>327,94</b>	<b>310,73</b>	<b>334,40</b>	<b>392,47</b>			
W				1030	1197	1355				959	1229	1496	1762	2032			
<b>2000</b>				<b>249,00</b>	<b>261,57</b>	<b>285,11</b>				<b>305,98</b>	<b>348,92</b>	<b>330,01</b>	<b>358,68</b>	<b>420,90</b>			
W				1144	1330	1506				1066	1366	1662	1958	2258			
<b>2300</b>											<b>356,24</b>	<b>385,52</b>	<b>458,60</b>				
W											1911	2252	2597				
<b>2600</b>																	
W																	
<b>3000</b>																	
W																	

## TIP 20 VKM

## TIP 21 VKM

Po naročilu



Režim ogrevanja 20°C:  
t1=75°C, t2=65°C

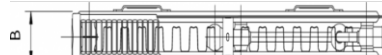

dolžina (mm)	višina (mm)							višina (mm)								
	200	300	400	500	600	700	900	200	300	400	500	600	700	900		
<b>400</b>											<b>190,20</b>	<b>193,37</b>	<b>193,74</b>	<b>210,21</b>	<b>234,85</b>	<b>245,22</b>
W											299	375	447	518	586	721
<b>500</b>				<b>221,76</b>	<b>236,66</b>	<b>253,44</b>				<b>201,54</b>	<b>203,25</b>	<b>206,42</b>	<b>224,60</b>	<b>253,27</b>	<b>266,33</b>	
W				467	540	611				374	469	559	647	733	901	
<b>600</b>				<b>234,81</b>	<b>251,56</b>	<b>270,19</b>				<b>211,43</b>	<b>216,31</b>	<b>221,43</b>	<b>237,29</b>	<b>270,72</b>	<b>289,14</b>	
W				560	648	733				449	562	671	776	880	1081	
<b>700</b>				<b>245,97</b>	<b>266,49</b>	<b>286,97</b>				<b>221,06</b>	<b>225,82</b>	<b>234,12</b>	<b>253,27</b>	<b>290,48</b>	<b>317,81</b>	
W				654	756	855				524	656	783	906	1026	1261	
<b>800</b>				<b>260,87</b>	<b>279,53</b>	<b>303,75</b>				<b>230,95</b>	<b>241,32</b>	<b>254,74</b>	<b>267,67</b>	<b>307,44</b>	<b>338,55</b>	
W				747	864	978				598	750	894	1035	1173	1442	
<b>900</b>				<b>273,92</b>	<b>294,43</b>	<b>320,53</b>				<b>240,58</b>	<b>250,95</b>	<b>267,67</b>	<b>280,72</b>	<b>326,35</b>	<b>361,97</b>	
W				841	972	1100				673	843	1006	1165	1319	1622	
<b>1000</b>				<b>288,85</b>	<b>307,48</b>	<b>337,28</b>				<b>248,64</b>	<b>262,79</b>	<b>280,72</b>	<b>296,83</b>	<b>343,31</b>	<b>381,74</b>	
W				934	1080	1222				748	937	1118	1294	1466	1802	
<b>1100</b>				<b>301,87</b>	<b>324,23</b>	<b>355,91</b>				<b>258,15</b>	<b>279,99</b>	<b>295,97</b>	<b>316,83</b>	<b>363,07</b>	<b>404,19</b>	
W				1027	1188	1344				823	1031	1230	1423	1613	1982	
<b>1200</b>				<b>313,07</b>	<b>339,16</b>	<b>372,69</b>				<b>268,03</b>	<b>297,19</b>	<b>310,73</b>	<b>337,33</b>	<b>382,23</b>	<b>426,39</b>	
W				1121	1296	1466				898	1124	1342	1553	1759	2162	
<b>1400</b>				<b>342,87</b>	<b>370,84</b>	<b>408,10</b>				<b>303,90</b>	<b>345,50</b>	<b>347,21</b>	<b>377,71</b>	<b>419,80</b>	<b>480,56</b>	
W				1308	1512	1711				1047	1312	1565	1812	2052	2523	
<b>1600</b>				<b>370,84</b>	<b>400,64</b>	<b>443,52</b>				<b>340,99</b>	<b>387,72</b>	<b>377,71</b>	<b>409,80</b>	<b>456,65</b>	<b>525,33</b>	
W				1494	1728	1955				1197	1499	1789	2070	2346	2883	
<b>1800</b>				<b>396,91</b>	<b>430,47</b>	<b>477,05</b>				<b>378,20</b>	<b>429,68</b>	<b>406,26</b>	<b>441,40</b>	<b>494,34</b>		
W				1681	1944	2200				1346	1687	2012	2329	2639		
<b>2000</b>				<b>424,86</b>	<b>462,15</b>	<b>512,46</b>				<b>413,70</b>	<b>471,41</b>	<b>435,30</b>	<b>475,19</b>	<b>533,26</b>		
W				1868	2160	2444				1496	1874	2236	2588	2932		
<b>2300</b>				<b>464,00</b>	<b>505,00</b>	<b>564,62</b>						<b>476,04</b>	<b>518,38</b>	<b>585,84</b>		
W				2148	2484	2811						2571	2976	3372		
<b>2600</b>																
W																
<b>3000</b>																
W																

TIP 22 VKM

TIP 33 VKM

Po naročilu

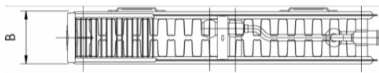

Režim ogrevanja 20°C:  
t1=75°C, t2=65°C



dolžina (mm)	višina (mm)							višina (mm)						
	200	300	400	500	600	700	900	200	300	400	500	600	700	900
<b>400</b>	<b>204,96</b>	<b>216,31</b>	<b>206,42</b>	<b>223,14</b>	<b>248,51</b>	<b>256,69</b>					<b>296,83</b>	<b>321,59</b>	<b>341,23</b>	<b>371,37</b>
W	380	482	579	672	762	934					830	964	1090	1314
<b>500</b>	<b>214,48</b>	<b>227,90</b>	<b>223,14</b>	<b>238,63</b>	<b>272,06</b>	<b>287,07</b>					<b>319,15</b>	<b>343,67</b>	<b>371,98</b>	<b>422,73</b>
W	475	602	724	840	953	1168					1038	1206	1362	1643
<b>600</b>	<b>225,82</b>	<b>237,29</b>	<b>237,29</b>	<b>249,12</b>	<b>293,90</b>	<b>314,15</b>					<b>338,31</b>	<b>366,73</b>	<b>418,70</b>	<b>462,26</b>
W	570	722	868	1008	1143	1401					1245	1447	1634	1972
<b>700</b>	<b>242,90</b>	<b>251,69</b>	<b>253,27</b>	<b>269,25</b>	<b>315,86</b>	<b>346,36</b>					<b>359,29</b>	<b>389,42</b>	<b>450,06</b>	<b>503,37</b>
W	665	843	1013	1176	1334	1635					1453	1688	1907	2300
<b>800</b>	<b>254,74</b>	<b>272,67</b>	<b>276,09</b>	<b>295,97</b>	<b>339,89</b>	<b>388,33</b>		<b>343,31</b>	<b>363,56</b>	<b>378,93</b>	<b>412,60</b>	<b>481,41</b>	<b>571,81</b>	
W	760	963	1158	1344	1524	1868		1065	1373	1660	1929	2179	2629	
<b>900</b>	<b>267,67</b>	<b>282,92</b>	<b>294,02</b>	<b>310,73</b>	<b>361,97</b>	<b>419,44</b>		<b>359,78</b>	<b>383,81</b>	<b>400,04</b>	<b>435,66</b>	<b>512,64</b>	<b>615,49</b>	
W	855	1084	1302	1512	1715	2102		1198	1544	1868	2170	2452	2957	
<b>1000</b>	<b>277,79</b>	<b>297,19</b>	<b>307,32</b>	<b>328,42</b>	<b>387,35</b>	<b>450,91</b>		<b>378,08</b>	<b>404,06</b>	<b>453,60</b>	<b>493,49</b>	<b>541,92</b>	<b>662,95</b>	
W	950	1204	1447	1680	1905	2335		1331	1716	2075	2411	2724	3286	
<b>1100</b>	<b>289,14</b>	<b>310,86</b>	<b>324,76</b>	<b>346,85</b>	<b>409,43</b>	<b>476,90</b>		<b>415,04</b>	<b>424,19</b>	<b>480,31</b>	<b>523,14</b>	<b>575,35</b>	<b>704,18</b>	
W	1045	1324	1592	1848	2096	2569		1464	1888	2283	2652	2996	3615	
<b>1200</b>	<b>300,73</b>	<b>323,79</b>	<b>342,09</b>	<b>367,95</b>	<b>431,64</b>	<b>502,64</b>		<b>431,76</b>	<b>446,64</b>	<b>507,03</b>	<b>552,78</b>	<b>606,58</b>	<b>745,42</b>	
W	1140	1445	1736	2016	2286	2802		1597	2059	2490	2893	3269	3943	
<b>1400</b>	<b>329,03</b>	<b>359,05</b>	<b>384,42</b>	<b>416,26</b>	<b>478,48</b>	<b>564,49</b>		<b>450,06</b>	<b>487,27</b>	<b>556,08</b>	<b>611,46</b>	<b>672,95</b>	<b>825,21</b>	
W	1330	1686	2026	2352	2667	3269		1863	2402	2905	3375	3814	4600	
<b>1600</b>	<b>352,21</b>	<b>389,30</b>	<b>416,26</b>	<b>460,79</b>	<b>526,43</b>	<b>618,54</b>		<b>484,95</b>	<b>527,53</b>	<b>607,68</b>	<b>672,95</b>	<b>741,27</b>	<b>914,88</b>	
W	1520	1926	2315	2688	3048	3736		2130	2746	3320	3858	4358	5258	
<b>1800</b>	<b>376,25</b>	<b>419,44</b>	<b>451,64</b>	<b>502,52</b>	<b>578,89</b>			<b>522,04</b>	<b>569,74</b>	<b>661,36</b>	<b>729,80</b>	<b>807,27</b>		
W	1710	2167	2605	3024	3429			2396	3089	3735	4340	4903		
<b>2000</b>	<b>396,26</b>	<b>448,11</b>	<b>487,27</b>	<b>545,95</b>	<b>629,76</b>			<b>558,88</b>	<b>610,49</b>	<b>713,09</b>	<b>791,41</b>	<b>875,59</b>		
W	1900	2408	2894	3360	3810			2662	3432	4150	4822	5448		
<b>2300</b>	<b>425,66</b>	<b>473,73</b>	<b>525,33</b>	<b>577,91</b>	<b>691,13</b>			<b>626,84</b>	<b>672,95</b>					
W	2185	2769	3328	3864	4382			3061	3947					
<b>2600</b>	<b>460,79</b>	<b>513,13</b>	<b>573,03</b>	<b>634,89</b>	<b>762,24</b>			<b>681,98</b>	<b>733,83</b>					
W	2470	3130	3762	4368	4953			3461	4462					
<b>3000</b>	<b>505,08</b>	<b>566,57</b>	<b>639,52</b>	<b>707,60</b>	<b>855,81</b>			<b>759,45</b>	<b>816,42</b>					
W	2850	3612	4341	5040	5715			3993	5148					

Režim ogrevanja 20°C:  
t1=75°C, t2=65°C

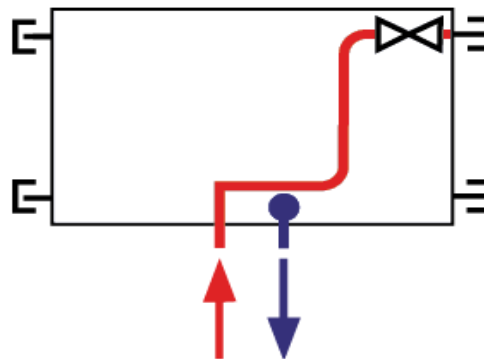
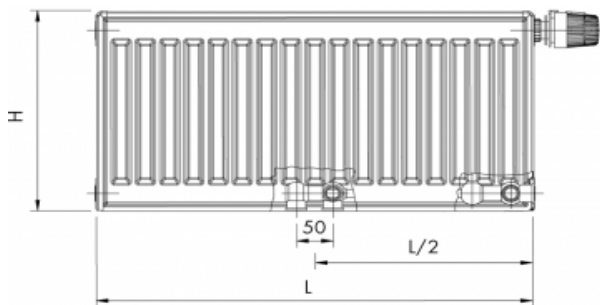

**BARVNA LESTVICA:** Standardna površinska barva radiatorjev je bela RAL 9016. Doplacilo 30% za drugo barvo s KORADO barvne lestvice (glej www.korado.si). Doplacilo 40% za drugo barvo z RAL lestvice.

SATIN GLOSS



HIGH GLOSS



MATTE



DEEP MATTE



## RADIK LINE VERTIKAL - M

Koda	EAN	Naziv	Dimenzije V/Š (mm)	W (Moč)	Cena
10160040-VOL0010	8590822831682	RADIK LINE VERTIKAL-M 10-1600/0400	602	507,441	507,441
10160060-VOL0010	8590822831767	RADIK LINE VERTIKAL-M 10-1600/0600	829	593,359	593,359
10160090-VOL0010	8590822831842	RADIK LINE VERTIKAL-M 10-1600/0900	1141	687,238	687,238
10180040-VOL0010	8590822831705	RADIK LINE VERTIKAL-M 10-1800/0400	661	535,412	535,412
10180060-VOL0010	8590822831781	RADIK LINE VERTIKAL-M 10-1800/0600	909	627,315	627,315
10180090-VOL0010	8590822831866	RADIK LINE VERTIKAL-M 10-1800/0900	1252	733,190	733,190
10200040-VOL0010	8590822831729	RADIK LINE VERTIKAL-M 10-2000/0400	717	565,388	565,388
10200060-VOL0010	8590822831804	RADIK LINE VERTIKAL-M 10-2000/0600	986	661,271	661,271
10200090-VOL0010	8590822831880	RADIK LINE VERTIKAL-M 10-2000/0900	1358	777,137	777,137
20160040-VOL0010	8590822831903	RADIK LINE VERTIKAL-M 20-1600/0400	677	565,388	565,388
20160060-VOL0010	8590822831989	RADIK LINE VERTIKAL-M 20-1600/0600	1185	651,279	651,279
20160090-VOL0010	8590822832061	RADIK LINE VERTIKAL-M 20-1600/0900	1659	787,129	787,129
20180040-VOL0010	8590822831927	RADIK LINE VERTIKAL-M 20-1800/0400	927	605,327	605,327
20180060-VOL0010	8590822832009	RADIK LINE VERTIKAL-M 20-1800/0600	1297	693,250	693,250
20180090-VOL0010	8590822832085	RADIK LINE VERTIKAL-M 20-1800/0900	1815	861,052	861,052
20200040-VOL0010	8590822831941	RADIK LINE VERTIKAL-M 20-2000/0400	1004	645,295	645,295
20200060-VOL0010	8590822832023	RADIK LINE VERTIKAL-M 20-2000/0600	1404	737,197	737,197
20200090-VOL0010	8590822832108	RADIK LINE VERTIKAL-M 20-2000/0900	1965	936,978	936,978

Režim ogrevanja 20°C: t1=75°C, t2=65°C

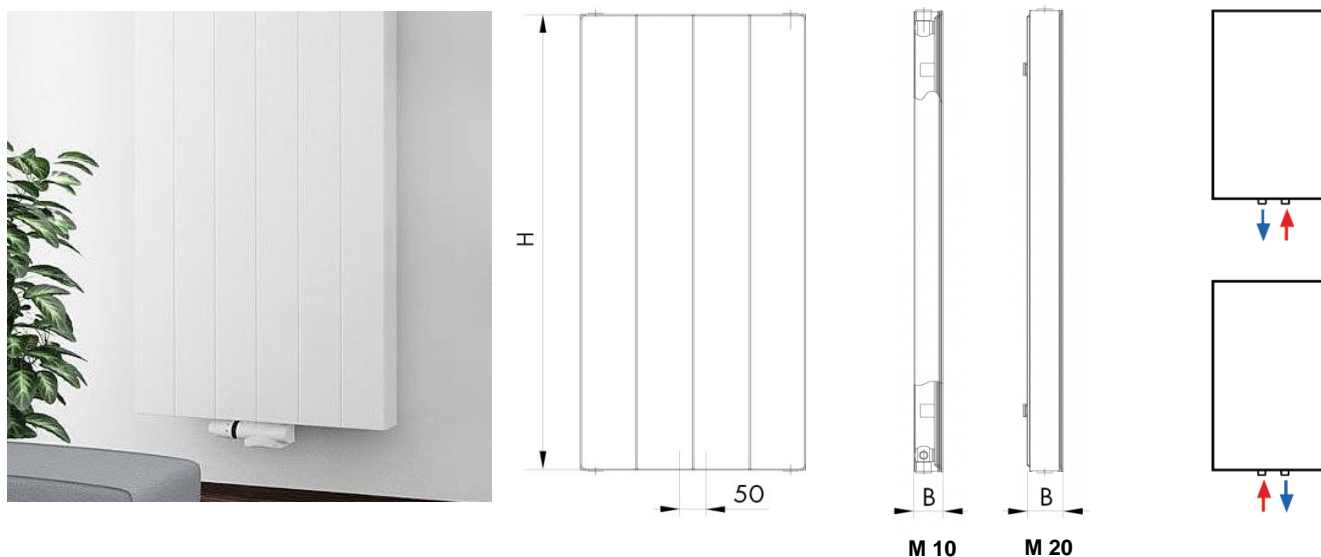

**BARVNA LESTVICA:** Standardna površinska barva radiatorjev je bela RAL 9016.

Doplačilo 30% za drugo barvo s KORADO barvne lestvice (glej [www.korado.si](http://www.korado.si)). Doplačilo 40% za drugo barvo z RAL lestvice.

### SATIN GLOSS



### HIGH GLOSS



### MATTE



### DEEP MATTE



## RADIK PLAN VERTIKAL - M

Koda	EAN	Naziv	Dimenzije V/Š (mm)	W (Moč)	Cena
10160040-V0P0010	8590822732224	RADIK PLAN VERTIKAL-M 10-1600/0400	602	507,44	
10160060-V0P0010	8590822732309	RADIK PLAN VERTIKAL-M 10-1600/0600	829	593,36	
10160090-V0P0010	8590822732385	RADIK PLAN VERTIKAL-M 10-1600/0900	1141	687,24	
10180040-V0P0010	8590822732248	RADIK PLAN VERTIKAL-M 10-1800/0400	661	535,41	
10180060-V0P0010	8590822732323	RADIK PLAN VERTIKAL-M 10-1800/0600	909	627,31	
10180090-V0P0010	8590822732408	RADIK PLAN VERTIKAL-M 10-1800/0900	1252	733,19	
10200040-V0P0010	8590822732262	RADIK PLAN VERTIKAL-M 10-2000/0400	717	565,39	
10200060-V0P0010	8590822732347	RADIK PLAN VERTIKAL-M 10-2000/0600	986	661,27	
10200090-V0P0010	8590822732422	RADIK PLAN VERTIKAL-M 10-2000/0900	1358	777,14	
20160040-V0P0010	8590822732446	RADIK PLAN VERTIKAL-M 20-1600/0400	677	565,39	
20160060-V0P0010	8590822732521	RADIK PLAN VERTIKAL-M 20-1600/0600	1185	651,28	
20160090-V0P0010	8590822732606	RADIK PLAN VERTIKAL-M 20-1600/0900	1659	787,13	
20180040-V0P0010	8590822732460	RADIK PLAN VERTIKAL-M 20-1800/0400	927	605,33	
20180060-V0P0010	8590822732545	RADIK PLAN VERTIKAL-M 20-1800/0600	1297	693,25	
20180090-V0P0010	8590822732620	RADIK PLAN VERTIKAL-M 20-1800/0900	1815	861,05	
20200040-V0P0010	8590822732484	RADIK PLAN VERTIKAL-M 20-2000/0400	1004	645,29	
20200060-V0P0010	8590822732569	RADIK PLAN VERTIKAL-M 20-2000/0600	1404	737,20	
20200090-V0P0010	8590822732644	RADIK PLAN VERTIKAL-M 20-2000/0900	1965	936,98	

Režim ogrevanja 20°C: t1=90°C, t2=70°C

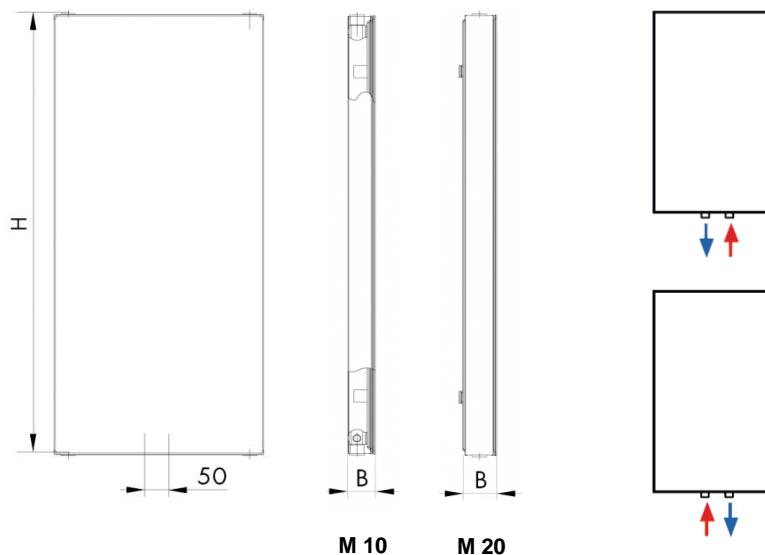

**BARVNA LESTVICA:** Standardna površinska barva radiatorjev je bela RAL 9016.

Doplačilo 30% za drugo barvo s KORADO barvne lestvice (glej [www.korado.si](http://www.korado.si)). Doplačilo 40% za drugo barvo z RAL lestvice.

### SATIN GLOSS



### HIGH GLOSS

### MATTE



### DEEP MATTE





Po naročilu										KORATHERM HORIZONTAL - TIP 10								KORATHERM HORIZONTAL - TIP 11							
dolžina (mm)	višina (mm)									višina (mm)															
	144	218	366	514	588	662	884	958	144	218	366	514	588	662	884	958									
<b>500</b>	113,74	135,71	177,58	220,49	241,46	263,40	327,27	348,20	142,68	167,63	217,50	266,41	291,34	316,29	391,11	416,06									
W	100	133	198	264	298	333	449	491	145	206	319	424	475	524	666	712									
<b>600</b>	119,72	142,68	189,56	235,48	258,42	281,37	351,23	374,15	149,68	176,60	230,48	284,36	311,31	338,25	419,05	445,98									
W	119	160	237	316	357	400	539	589	173	247	383	509	569	629	799	854									
<b>700</b>	125,72	150,67	200,54	250,45	275,37	299,33	374,15	399,10	157,65	186,57	244,45	302,32	331,24	361,18	447,98	476,91									
W	139	186	277	369	417	466	629	687	202	288	447	594	664	734	932	996									
<b>800</b>	131,70	158,64	211,52	264,42	291,34	318,27	398,11	424,05	164,64	195,57	258,42	320,26	352,21	383,14	476,91	507,87									
W	159	213	316	422	476	533	718	786	231	329	510	678	759	838	1066	1138									
<b>900</b>	137,70	165,64	222,52	279,38	308,32	336,26	421,07	450,00	171,62	205,52	272,39	338,25	372,16	405,08	504,85	538,79									
W	179	239	356	474	536	599	808	884	260	370	574	763	854	943	1199	1281									
<b>1000</b>	143,68	173,61	233,46	294,35	324,28	354,20	445,00	474,92	179,61	214,51	285,36	356,20	392,13	427,04	533,79	568,73									
W	199	266	395	527	595	666	898	982	289	411	638	848	949	1048	1332	1423									
<b>1100</b>	149,68	181,60	245,44	309,32	341,23	373,16	467,96	499,87	186,57	224,50	299,33	374,15	412,08	450,00	561,72	599,65									
W	219	293	435	580	655	733	988	1080	318	452	702	933	1044	1153	1465	1565									
<b>1200</b>	155,65	188,56	256,42	323,29	357,19	391,11	491,90	525,82	194,58	233,46	313,30	392,13	432,01	471,93	590,66	630,57									
W	239	319	474	632	714	799	1078	1178	347	493	766	1018	1139	1258	1598	1708									
<b>1400</b>	167,63	204,53	278,39	353,21	390,11	427,04	538,79	575,69	208,55	252,44	340,23	428,04	471,93	515,83	647,53	691,46									
W	279	372	553	738	833	932	1257	1375	405	575	893	1187	1329	1467	1865	1992									
<b>1600</b>	178,61	219,49	301,32	382,14	423,06	463,97	585,69	626,59	223,50	272,39	368,17	463,97	512,85	560,72	704,40	753,31									
W	318	426	632	843	952	1066	1437	1571	462	658	1021	1357	1518	1677	2131	2277									
<b>1800</b>	190,56	235,48	323,29	412,08	455,98	499,87	632,57	677,49	238,47	291,34	395,12	499,87	552,76	604,63	762,27	814,17									
W	358	479	711	949	1071	1199	1616	1768	520	740	1148	1526	1708	1886	2398	2561									
<b>2000</b>	202,54	250,45	346,21	441,01	488,89	536,80	680,48	727,36	253,43	310,31	423,06	535,81	592,68	649,55	819,14	875,02									
W	398	532	790	1054	1190	1332	1796	1964	578	822	1276	1696	1898	2096	2664	2846									
<b>2300</b>	220,49	273,38	379,16	485,90	538,79	591,69	750,32	803,19	275,37	338,25	463,97	589,66	652,54	715,38	904,95	967,83									
W	458	612	909	1212	1369	1532	2065	2259	665	945	1467	1950	2183	2410	3064	3273									
<b>2600</b>	238,47	296,34	413,07	529,81	587,67	646,54	821,17	880,02	297,34	367,18	505,85	643,55	713,40	782,24	989,76	1.059,61									
W	517	692	1027	1370	1547	1732	2335	2553	751	1069	1659	2205	2467	2725	3463	3700									
<b>3000</b>	261,40	327,27	457,96	588,66	653,53	719,37	914,94	980,79	327,27	405,08	560,72	715,38	793,22	871,04	1.104,50										
W	597	798	1185	1581	1785	1998	2694	2946	867	1233	1914	2544	2847	3144	3996										

Po naročilu										KORATHERM HORIZONTAL - TIP 20								KORATHERM HORIZONTAL - TIP 21							
dolžina (mm)	višina (mm)									višina (mm)															
	144	218	366	514	588	662	884	958	144	218	366	514	588	662	884	958									
<b>500</b>	240,46	283,37	370,17	457,96	500,87	544,77	675,47	718,37	260,41	308,32	403,09	497,88	545,77	593,68	736,36	783,24									
W	159	220	334	446	503	560	738	800	209	291	436	564	624	680	837	886									
<b>600</b>	252,44	299,33	394,12	487,89	534,81	582,70	723,37	770,27	275,37	327,27	431,03	534,81	586,67	638,57	794,22	846,08									
W	191	263	400	535	604	672	886	959	250	349	523	677	748	816	1004	1063									
<b>700</b>	265,41	316,29	417,06	518,82	569,72	619,59	772,26	822,16	290,34	346,21	458,96	570,72	627,59	683,47	852,08	907,96									
W	223	307	467	624	704	784	1033	1119	292	407	610	790	873	952	1172	1240									
<b>800</b>	277,37	332,24	441,01	548,78	603,63	657,52	820,17	875,02	304,30	365,19	485,90	607,65	667,50	728,36	909,96	970,82									
W	254	351	534	714	805	896	1181	1279	334	465	697	902	998	1088	1339	1417									
<b>900</b>	290,34	348,20	463,97	579,71	637,57	695,44	869,04	926,92	319,27	384,14	513,84	643,55	708,42	773,25	967,83	1.032,67									
W	286	395	600	803	905	1008	1328	1439	375	523	784	1015	1122	1224	1507	1594									
<b>1000</b>	302,32	364,19	486,90	609,63	671,49	733,34	916,93	978,81	334,23	403,09	541,78	679,48	749,32	818,14	1.025,69	1.094,55									
W	318	439	667	892	1006	1120	1476	1599	417	581	871	1128	1247	1360	1674	1771									
<b>1100</b>	315,28	380,15	510,85	640,56	705,40	770,27	965,84	1.030,67	349,23	422,06	569,72	716,38	790,21	863,08	1.083,57	1.157,39									
W	350	483	734	981	1107	1232	1624	1759	459	639	958	1241	1372	1496	1841	1948									
<b>1200</b>	328,27	396,11	533,79	671,49	739,34	808,19	1.014,71	1.082,57	364,19	442,01	596,67	752,31	830,12	907,96	1.141,43	1.219,27									
W	382	527	800	1070	1207	1344	1771	1919	500	697	1045	1354	1496	1632	2009	2125									
<b>1400</b>	353,21	429,04	580,70	732,34	808,19	884,01	1.111,51	1.187,32	393,13	479,94	652,54	825,15	911,95	997,75	1.257,16	1.343,96									
W	445	615	934	1249	1408	1568	2066	2239	584	813	1219	1579	1746	1904	2344	2479									
<b>1600</b>	378,16	460,95	626,59	793,22	876,02	958,83	1.208,29	1.291,10	423,06	517,83	708,42	897,98	992,78	1.087,54	1.372,90	1.467,70									
W	509	702	1067	1427	1610	1792	2362	2558	667	930	1394	1805	1995	2176	2678	2834									
<b>1800</b>	403,09	492,90	673,48	854,09	943,87	1.034,68	1.305,08	1.394,86	451,99	555,75	763,29	970,82	1.074,58	1.178,36	1.488,64										
W	572	790	1201	1606	1811	2016	2657	2878	751	1046	1568	2030	2245	2448	3013										
<b>2000</b>	428,04	525,82	720,40	914,94	1.012,72	1.109,50	1.401,84		481,92	594,66	819,14	1.043,65	1.155,40	1.268,15											
W	636	878	1334	1784	2012	2240	2952		834	1162	1742	2256	2494	2720											
<b>2300</b>	465,95	573,71	790,21	1.006,74	1.114,48	1.223,26			525,82	651,54	901,96	1.152,41	1.277,13	1.402,83											
W	731	1010	1534	2052	2314	2576			959	1336	2003	2594	2868	3128											
<b>2600</b>	502,86	621,61	860,05	1.097,54	1.217,26	1.336,00			570,72	708,42	984,78	1.261,15	1.399,84												
W	827	1141	1734	2319	2616	2912			1084	1511	2265	2933	3242												
<b>3000</b>	552,76	686,45	952,86	1.220,27	1.352,96				629,58	785,23	1.095,54	1.406,84													
W	954	1317	2001	2676	3018				1251	1743	2613	3384													

KORATHERM HORIZONTAL - TIP 22									
dolžina (mm)	višina (mm)								
	144	218	366	514	588	662	884	958	
<b>500</b>	<b>294,35</b>	<b>344,22</b>	<b>445,00</b>	<b>546,76</b>	<b>596,67</b>	<b>647,53</b>	<b>798,21</b>	<b>849,11</b>	
W	267	375	604	777	854	927	1119	1176	
<b>600</b>	<b>311,31</b>	<b>366,18</b>	<b>475,92</b>	<b>585,69</b>	<b>640,56</b>	<b>695,44</b>	<b>861,05</b>	<b>915,93</b>	
W	320	449	724	932	1025	1112	1343	1411	
<b>700</b>	<b>327,27</b>	<b>387,13</b>	<b>505,85</b>	<b>625,59</b>	<b>685,46</b>	<b>744,32</b>	<b>922,93</b>	<b>982,80</b>	
W	374	524	845	1088	1196	1297	1567	1646	
<b>800</b>	<b>344,22</b>	<b>408,09</b>	<b>536,80</b>	<b>664,52</b>	<b>729,35</b>	<b>793,22</b>	<b>985,77</b>	<b>1.049,65</b>	
W	427	599	966	1243	1366	1482	1790	1881	
<b>900</b>	<b>361,18</b>	<b>430,03</b>	<b>566,73</b>	<b>704,40</b>	<b>773,25</b>	<b>842,11</b>	<b>1.047,66</b>	<b>1.116,48</b>	
W	481	674	1086	1399	1537	1668	2014	2116	
<b>1000</b>	<b>377,14</b>	<b>451,00</b>	<b>597,65</b>	<b>744,32</b>	<b>817,16</b>	<b>891,01</b>	<b>1.110,51</b>	<b>1.183,34</b>	
W	534	749	1207	1554	1708	1853	2238	2351	
<b>1100</b>	<b>394,12</b>	<b>471,93</b>	<b>627,59</b>	<b>783,24</b>	<b>861,05</b>	<b>938,89</b>	<b>1.173,35</b>	<b>1.250,20</b>	
W	587	824	1328	1709	1879	2038	2462	2586	
<b>1200</b>	<b>411,08</b>	<b>493,90</b>	<b>658,51</b>	<b>823,16</b>	<b>905,97</b>	<b>987,77</b>	<b>1.235,23</b>	<b>1.318,03</b>	
W	641	899	1448	1865	2050	2224	2686	2821	
<b>1400</b>	<b>443,99</b>	<b>535,81</b>	<b>719,37</b>	<b>901,96</b>	<b>993,78</b>	<b>1.085,56</b>	<b>1.359,93</b>	<b>1.451,74</b>	
W	748	1049	1690	2176	2391	2594	3133	3291	
<b>1600</b>	<b>477,94</b>	<b>578,71</b>	<b>780,25</b>	<b>981,80</b>	<b>1.081,57</b>	<b>1.182,34</b>			
W	854	1198	1931	2486	2733	2965			
<b>1800</b>	<b>510,85</b>	<b>620,61</b>	<b>841,10</b>	<b>1.060,61</b>	<b>1.170,36</b>	<b>1.280,12</b>			
W	961	1348	2173	2797	3074	3335			
<b>2000</b>	<b>544,77</b>	<b>663,52</b>	<b>901,96</b>	<b>1.139,44</b>	<b>1.258,16</b>	<b>1.377,90</b>			
W	1068	1498	2414	3108	3416	3706			
<b>2300</b>	<b>594,66</b>	<b>727,36</b>	<b>992,78</b>	<b>1.258,16</b>	<b>1.390,89</b>				
W	1228	1723	2776	3574	3928				
<b>2600</b>	<b>644,54</b>	<b>791,23</b>	<b>1.083,57</b>	<b>1.376,92</b>					
W	1388	1947	3138	4040					
<b>3000</b>	<b>711,41</b>	<b>876,02</b>	<b>1.205,30</b>						
W	1602	2247	3621						

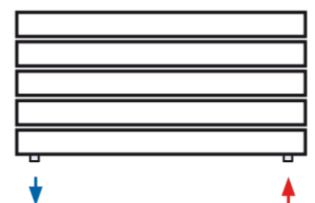
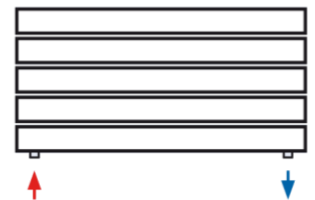
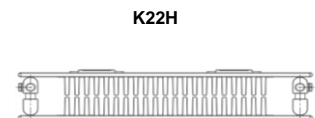

Režim ogrevanja 20°C: t1=75°C, t2=65°C

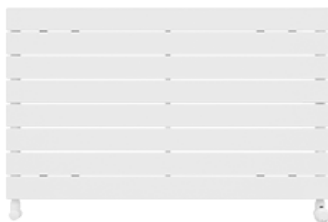

**BARVNA LESTVICA:** Standardna površinska barva radiatorjev je bela RAL 9016. Doplacilo 30% za drugo barvo s KORADO barvne lestvice (glej www.korado.si). Doplacilo 40% za drugo barvo z RAL lestvice.

### SATIN GLOSS



### HIGH GLOSS



### MATTE



### DEEP MATTE



Po naročilu

Režim ogrevanja 20°C: t1=75°C, t2=65°C

## KORATHERM HORIZONTAL VKM - TIP 11

## KORATHERM HORIZONTAL VKM - TIP 20

dolžina (mm)	višina (mm)						višina (mm)					
	218	366	514	588	662	884	218	366	514	588	662	884
<b>500</b>							<b>474,92</b>	<b>562,73</b>	<b>605,62</b>	<b>649,55</b>	<b>780,25</b>	
W							371	495	556	618	805	
<b>600</b>	<b>335,26</b>	<b>389,12</b>	<b>416,06</b>	<b>443,01</b>	<b>523,83</b>		<b>498,88</b>	<b>592,68</b>	<b>639,56</b>	<b>687,45</b>	<b>828,14</b>	
W	383	509	569	629	799		445	593	667	741	966	
<b>700</b>	<b>349,23</b>	<b>407,10</b>	<b>436,03</b>	<b>465,95</b>	<b>552,76</b>		<b>521,84</b>	<b>623,60</b>	<b>674,48</b>	<b>724,38</b>	<b>877,05</b>	
W	447	594	664	734	932		519	692	778	865	1127	
<b>800</b>	<b>363,17</b>	<b>425,05</b>	<b>456,98</b>	<b>487,89</b>	<b>581,70</b>		<b>545,77</b>	<b>653,53</b>	<b>708,42</b>	<b>762,27</b>	<b>924,92</b>	
W	510	678	759	838	1066		594	791	890	988	1288	
<b>900</b>	<b>377,14</b>	<b>443,01</b>	<b>476,91</b>	<b>509,86</b>	<b>609,63</b>		<b>568,73</b>	<b>684,46</b>	<b>742,33</b>	<b>800,20</b>	<b>973,80</b>	
W	574	763	854	943	1199		668	890	1001	1112	1449	
<b>1000</b>	<b>390,11</b>	<b>460,95</b>	<b>496,88</b>	<b>531,80</b>	<b>638,57</b>		<b>591,69</b>	<b>714,40</b>	<b>776,24</b>	<b>838,12</b>	<b>1.021,71</b>	
W	638	848	949	1048	1332		742	989	1112	1235	1610	
<b>1100</b>	<b>404,08</b>	<b>478,94</b>	<b>516,83</b>	<b>554,76</b>	<b>666,51</b>		<b>615,61</b>	<b>745,31</b>	<b>810,18</b>	<b>875,02</b>	<b>1.070,59</b>	
W	702	933	1044	1153	1465		816	1088	1223	1359	1771	
<b>1200</b>	<b>418,05</b>	<b>496,88</b>	<b>536,80</b>	<b>576,69</b>	<b>695,44</b>		<b>638,57</b>	<b>776,24</b>	<b>844,09</b>	<b>912,95</b>	<b>1.119,50</b>	
W	766	1018	1139	1258	1598		890	1187	1334	1482	1932	
<b>1400</b>	<b>445,00</b>	<b>532,79</b>	<b>576,69</b>	<b>620,61</b>	<b>752,31</b>		<b>685,46</b>	<b>837,13</b>	<b>912,95</b>	<b>988,76</b>	<b>1.216,25</b>	
W	893	1187	1329	1467	1865		1039	1385	1557	1729	2254	
<b>1600</b>	<b>472,93</b>	<b>568,73</b>	<b>617,60</b>	<b>665,51</b>	<b>809,19</b>		<b>731,34</b>	<b>897,98</b>	<b>980,79</b>	<b>1.063,62</b>	<b>1.313,04</b>	
W	1021	1357	1518	1677	2131		1187	1582	1779	1976	2576	
<b>1800</b>	<b>499,87</b>	<b>604,63</b>	<b>657,52</b>	<b>709,41</b>	<b>867,05</b>		<b>778,26</b>	<b>958,83</b>	<b>1.048,65</b>	<b>1.139,44</b>	<b>1.409,83</b>	
W	1148	1526	1708	1886	2398		1336	1780	2002	2223	2898	
<b>2000</b>	<b>527,81</b>	<b>640,56</b>	<b>697,44</b>	<b>754,30</b>	<b>923,93</b>		<b>825,15</b>	<b>1.019,72</b>	<b>1.117,47</b>	<b>1.214,27</b>	<b>1.506,61</b>	
W	1276	1696	1898	2096	2664		1484	1978	2224	2470	3220	

## KORATHERM HORIZONTAL VKM - TIP 21

## KORATHERM HORIZONTAL VKM - TIP 22

dolžina (mm)	višina (mm)						višina (mm)					
	218	366	514	588	662	884	218	366	514	588	662	884
<b>500</b>	<b>413,07</b>	<b>507,87</b>	<b>602,63</b>	<b>650,55</b>	<b>698,43</b>	<b>841,10</b>	<b>449,01</b>	<b>549,78</b>	<b>651,54</b>	<b>701,41</b>	<b>752,31</b>	<b>902,96</b>
W	291	436	564	624	680	837	375	604	777	854	927	1119
<b>600</b>	<b>432,01</b>	<b>535,81</b>	<b>639,56</b>	<b>691,46</b>	<b>743,32</b>	<b>898,98</b>	<b>470,94</b>	<b>580,70</b>	<b>690,43</b>	<b>745,31</b>	<b>800,20</b>	<b>965,84</b>
W	349	523	677	748	816	1004	449	724	932	1025	1112	1343
<b>700</b>	<b>451,00</b>	<b>563,75</b>	<b>675,47</b>	<b>732,34</b>	<b>788,22</b>	<b>956,85</b>	<b>491,90</b>	<b>610,63</b>	<b>730,35</b>	<b>790,21</b>	<b>849,11</b>	<b>1.027,69</b>
W	407	610	790	873	952	1172	524	845	1088	1196	1297	1567
<b>800</b>	<b>469,94</b>	<b>590,66</b>	<b>712,39</b>	<b>772,26</b>	<b>833,11</b>	<b>1.014,71</b>	<b>512,85</b>	<b>641,56</b>	<b>769,27</b>	<b>834,14</b>	<b>897,98</b>	<b>1.090,56</b>
W	465	697	902	998	1088	1339	599	966	1243	1366	1482	1790
<b>900</b>	<b>488,89</b>	<b>618,60</b>	<b>748,34</b>	<b>813,17</b>	<b>878,03</b>	<b>1.072,58</b>	<b>534,81</b>	<b>671,49</b>	<b>809,19</b>	<b>878,03</b>	<b>946,85</b>	<b>1.152,41</b>
W	523	784	1015	1122	1224	1507	674	1086	1399	1537	1668	2014
<b>1000</b>	<b>507,87</b>	<b>646,54</b>	<b>784,24</b>	<b>854,09</b>	<b>922,93</b>	<b>1.130,45</b>	<b>555,75</b>	<b>702,42</b>	<b>849,11</b>	<b>921,93</b>	<b>995,76</b>	<b>1.215,25</b>
W	581	871	1128	1247	1360	1674	749	1207	1554	1708	1853	2238
<b>1100</b>	<b>526,82</b>	<b>674,48</b>	<b>821,17</b>	<b>894,99</b>	<b>967,83</b>	<b>1.188,32</b>	<b>576,69</b>	<b>732,34</b>	<b>887,99</b>	<b>965,84</b>	<b>1.043,65</b>	<b>1.278,13</b>
W	639	958	1241	1372	1496	1841	824	1328	1709	1879	2038	2462
<b>1200</b>	<b>546,76</b>	<b>701,41</b>	<b>857,07</b>	<b>934,91</b>	<b>1.012,72</b>	<b>1.246,18</b>	<b>598,65</b>	<b>763,29</b>	<b>927,91</b>	<b>1.010,73</b>	<b>1.092,55</b>	<b>1.339,99</b>
W	697	1045	1354	1496	1632	2009	899	1448	1865	2050	2224	2686
<b>1400</b>	<b>584,69</b>	<b>757,29</b>	<b>929,90</b>	<b>1.016,70</b>	<b>1.102,51</b>	<b>1.361,95</b>	<b>640,56</b>	<b>824,15</b>	<b>1.006,74</b>	<b>1.098,52</b>	<b>1.190,34</b>	<b>1.464,71</b>
W	813	1219	1579	1746	1904	2344	1049	1690	2176	2391	2594	3133
<b>1600</b>	<b>622,60</b>	<b>813,17</b>	<b>1.002,73</b>	<b>1.097,54</b>	<b>1.192,33</b>	<b>1.477,69</b>	<b>683,47</b>	<b>885,01</b>	<b>1.086,54</b>	<b>1.186,33</b>	<b>1.287,10</b>	
W	930	1394	1805	1995	2176	2678	1198	1931	2486	2733	2965	
<b>1800</b>	<b>660,51</b>	<b>868,05</b>	<b>1.075,56</b>	<b>1.179,35</b>	<b>1.283,11</b>	<b>1.593,42</b>	<b>725,38</b>	<b>945,87</b>	<b>1.165,38</b>	<b>1.275,12</b>	<b>1.384,88</b>	
W	1046	1568	2030	2245	2448	3013	1348	2173	2797	3074	3335	
<b>2000</b>	<b>699,43</b>	<b>923,93</b>	<b>1.148,43</b>	<b>1.260,15</b>	<b>1.372,90</b>		<b>768,27</b>	<b>1.006,74</b>	<b>1.244,19</b>	<b>1.362,95</b>	<b>1.482,67</b>	
W	1162	1742	2256	2494	2720		1498	2414	3108	3416	3706	

KORATHERM VERTIKAL - TIP 10										KORATHERM VERTIKAL - TIP 11							
višina (mm)	širina (mm)									širina (mm)							
	144	218	366	514	588	662	884	958		144	218	366	514	588	662	884	958
<b>500</b>	<b>141,68</b>	<b>162,63</b>	<b>205,52</b>	<b>248,43</b>	<b>270,39</b>	<b>291,34</b>	<b>356,20</b>	<b>377,14</b>		<b>170,62</b>	<b>195,57</b>	<b>245,44</b>	<b>295,34</b>	<b>320,26</b>	<b>345,21</b>	<b>421,07</b>	<b>445,98</b>
W	90	136	229	322	368	414	553	600		118	179	301	423	483	544	727	787
<b>600</b>	<b>147,66</b>	<b>170,62</b>	<b>217,50</b>	<b>263,40</b>	<b>287,35</b>	<b>310,31</b>	<b>380,15</b>	<b>403,09</b>		<b>177,58</b>	<b>205,52</b>	<b>259,41</b>	<b>313,30</b>	<b>341,23</b>	<b>368,17</b>	<b>449,01</b>	<b>476,91</b>
W	107	162	272	382	437	492	657	712		139	210	353	495	567	638	852	924
<b>700</b>	<b>153,66</b>	<b>178,61</b>	<b>228,48</b>	<b>278,39</b>	<b>303,30</b>	<b>328,27</b>	<b>403,09</b>	<b>429,04</b>		<b>185,59</b>	<b>214,51</b>	<b>273,38</b>	<b>332,24</b>	<b>361,18</b>	<b>390,11</b>	<b>477,94</b>	<b>507,87</b>
W	124	187	315	442	506	569	760	824		159	240	403	566	648	730	974	1056
<b>800</b>	<b>159,64</b>	<b>186,57</b>	<b>239,46</b>	<b>293,35</b>	<b>320,26</b>	<b>347,21</b>	<b>427,04</b>	<b>453,99</b>		<b>192,58</b>	<b>224,50</b>	<b>287,35</b>	<b>350,23</b>	<b>381,15</b>	<b>413,07</b>	<b>506,87</b>	<b>538,79</b>
W	141	213	358	502	574	647	864	936		178	270	453	636	727	819	1094	1185
<b>900</b>	<b>165,64</b>	<b>193,58</b>	<b>251,44</b>	<b>308,32</b>	<b>336,26</b>	<b>365,19</b>	<b>451,00</b>	<b>479,94</b>		<b>200,54</b>	<b>233,46</b>	<b>301,32</b>	<b>368,17</b>	<b>401,10</b>	<b>435,04</b>	<b>535,81</b>	<b>569,72</b>
W	157	238	400	562	643	724	966	1047		197	298	501	704	805	906	1210	1312
<b>1000</b>	<b>171,62</b>	<b>201,54</b>	<b>262,40</b>	<b>323,29</b>	<b>353,21</b>	<b>384,14</b>	<b>474,92</b>	<b>504,85</b>		<b>207,55</b>	<b>243,45</b>	<b>315,28</b>	<b>386,13</b>	<b>422,06</b>	<b>456,98</b>	<b>564,74</b>	
W	174	263	442	621	710	800	1068	1157		216	327	548	770	881	992	1324	
<b>1100</b>	<b>177,58</b>	<b>209,54</b>	<b>273,38</b>	<b>338,25</b>	<b>370,17</b>	<b>402,09</b>	<b>498,88</b>	<b>530,80</b>		<b>215,51</b>	<b>253,43</b>	<b>328,27</b>	<b>404,08</b>	<b>442,01</b>	<b>479,94</b>	<b>593,68</b>	
W	191	289	485	681	779	876	1170	1268		234	354	595	836	956	1076	1437	
<b>1200</b>	<b>183,59</b>	<b>217,50</b>	<b>285,36</b>	<b>352,21</b>	<b>386,13</b>	<b>420,05</b>	<b>521,84</b>	<b>555,75</b>		<b>222,52</b>	<b>262,40</b>	<b>342,23</b>	<b>422,06</b>	<b>461,95</b>	<b>501,86</b>	<b>621,61</b>	
W	207	314	527	740	846	953	1272	1379		252	382	641	900	1030	1159	1548	
<b>1400</b>	<b>195,57</b>	<b>232,47</b>	<b>307,32</b>	<b>382,14</b>	<b>420,05</b>	<b>456,98</b>	<b>569,72</b>	<b>606,65</b>		<b>237,47</b>	<b>281,37</b>	<b>370,17</b>	<b>458,96</b>	<b>502,86</b>	<b>546,76</b>	<b>679,48</b>	
W	240	364	611	858	982	1106	1476	1600		287	435	731	1026	1174	1321	1764	
<b>1600</b>	<b>207,55</b>	<b>248,43</b>	<b>330,25</b>	<b>412,08</b>	<b>452,99</b>	<b>493,90</b>	<b>616,60</b>	<b>658,51</b>		<b>252,44</b>	<b>301,32</b>	<b>398,11</b>	<b>494,89</b>	<b>542,78</b>	<b>591,69</b>	<b>737,34</b>	
W	274	414	695	977	1117	1258	1680	1820		322	487	818	1148	1314	1479	1975	
<b>1800</b>	<b>218,50</b>	<b>263,40</b>	<b>352,21</b>	<b>442,01</b>	<b>485,90</b>	<b>530,80</b>	<b>664,52</b>	<b>709,41</b>		<b>267,40</b>	<b>320,26</b>	<b>426,05</b>	<b>530,80</b>	<b>583,68</b>	<b>636,58</b>	<b>794,22</b>	
W	307	465	780	1095	1253	1411	1884	2041		355	538	903	1268	1450	1632	2180	
<b>2000</b>	<b>230,48</b>	<b>279,38</b>	<b>375,15</b>	<b>470,94</b>	<b>519,82</b>	<b>567,73</b>	<b>712,39</b>	<b>760,28</b>		<b>282,37</b>	<b>339,25</b>	<b>452,99</b>	<b>567,73</b>	<b>624,60</b>	<b>681,47</b>	<b>852,08</b>	
W	340	515	865	1215	1389	1564	2089	2264		388	587	985	1384	1583	1782	2380	

KORATHERM VERTIKAL - TIP 20									
višina (mm)	širina (mm)								
	144	218	366	514	588	662	884	958	
<b>500</b>	<b>270,39</b>	<b>314,30</b>	<b>402,09</b>	<b>488,89</b>	<b>532,79</b>	<b>576,69</b>	<b>708,42</b>	<b>752,31</b>	
W	137	207	348	489	559	630	841	911	
<b>600</b>	<b>282,37</b>	<b>330,25</b>	<b>425,05</b>	<b>519,82</b>	<b>567,73</b>	<b>614,61</b>	<b>757,29</b>	<b>805,18</b>	
W	161	244	410	576	659	742	991	1074	
<b>700</b>	<b>295,34</b>	<b>346,21</b>	<b>449,01</b>	<b>550,77</b>	<b>601,64</b>	<b>652,54</b>	<b>806,20</b>	<b>857,07</b>	
W	185	281	471	662	757	853	1139	1234	
<b>800</b>	<b>308,32</b>	<b>363,17</b>	<b>471,93</b>	<b>581,70</b>	<b>636,58</b>	<b>691,46</b>	<b>855,07</b>	<b>909,96</b>	
W	209	317	532	747	854	962	1284	1392	
<b>900</b>	<b>320,26</b>	<b>379,16</b>	<b>495,89</b>	<b>612,62</b>	<b>670,49</b>	<b>729,35</b>	<b>903,96</b>	<b>961,82</b>	
W	233	352	591	831	950	1070	1429	1548	
<b>1000</b>	<b>333,24</b>	<b>395,12</b>	<b>518,82</b>	<b>643,55</b>	<b>705,40</b>	<b>767,28</b>	<b>952,86</b>	<b>1.014,71</b>	
W	256	387	650	913	1045	1176	1571	1702	
<b>1100</b>	<b>346,21</b>	<b>412,08</b>	<b>542,78</b>	<b>673,48</b>	<b>739,34</b>	<b>805,18</b>	<b>1.001,74</b>	<b>1.067,60</b>	
W	279	422	709	996	1139	1282	1712	1856	
<b>1200</b>	<b>359,19</b>	<b>428,04</b>	<b>566,73</b>	<b>704,40</b>	<b>774,25</b>	<b>843,09</b>	<b>1.050,64</b>	<b>1.119,50</b>	
W	302	457	767	1077	1232	1387	1852	2007	
<b>1400</b>	<b>384,14</b>	<b>459,95</b>	<b>613,62</b>	<b>766,28</b>	<b>842,11</b>	<b>918,92</b>	<b>1.148,43</b>	<b>1.224,25</b>	
W	347	525	881	1237	1415	1593	2128	2306	
<b>1600</b>	<b>409,09</b>	<b>492,90</b>	<b>660,51</b>	<b>827,14</b>	<b>910,95</b>	<b>994,76</b>	<b>1.246,18</b>	<b>1.330,00</b>	
W	391	592	994	1396	1596	1797	2400	2601	
<b>1800</b>	<b>435,04</b>	<b>525,82</b>	<b>707,42</b>	<b>888,99</b>	<b>979,81</b>	<b>1.070,59</b>	<b>1.343,96</b>	<b>1.434,78</b>	
W	435	658	1105	1552	1775	1999	2669	2892	
<b>2000</b>	<b>459,95</b>	<b>557,75</b>	<b>754,30</b>	<b>950,87</b>	<b>1.048,65</b>	<b>1.146,41</b>	<b>1.441,75</b>		
W	478	724	1215	1706	1952	2198	2935		

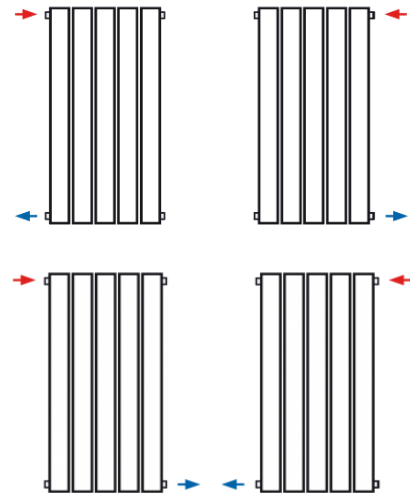
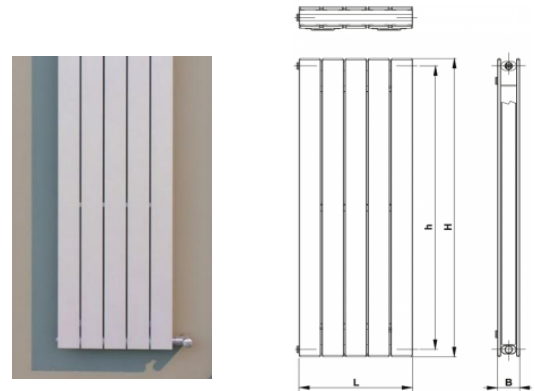

SATIN GLOSS



MATTE



DEEP MATTE



**BARVNA LESTVICA:** Standardna površinska barva radiatorjev je bela RAL 9016.

Doplačilo 30% za drugo barvo s KORADO barvne lestvice (glej [www.korado.si](http://www.korado.si)).

Doplačilo 40% za drugo barvo z RAL lestvice.

Po naročilu

Režim ogrevanja 20°C: t1=75°C, t2=65°C

višina (mm)	KORATHERM VERTIKAL M - TIP 10									KORATHERM VERTIKAL M - TIP 11								
	dolžina (mm)									dolžina (mm)								
	144	218	366	514	588	662	884	958		144	218	366	514	588	662	884	958	
<b>500</b>	<b>168,63</b>	<b>189,56</b>	<b>232,47</b>	<b>275,37</b>	<b>297,34</b>	<b>318,27</b>	<b>383,14</b>	<b>404,08</b>		<b>197,55</b>	<b>222,52</b>	<b>272,39</b>	<b>322,29</b>	<b>347,21</b>	<b>372,16</b>	<b>447,98</b>	<b>472,93</b>	
W	90	136	229	322	368	414	553	600		118	179	301	423	483	544	727	787	
<b>600</b>	<b>174,59</b>	<b>197,55</b>	<b>244,45</b>	<b>290,34</b>	<b>314,30</b>	<b>337,26</b>	<b>407,10</b>	<b>430,03</b>		<b>204,53</b>	<b>232,47</b>	<b>286,36</b>	<b>340,23</b>	<b>368,17</b>	<b>395,12</b>	<b>475,92</b>	<b>503,86</b>	
W	107	162	272	382	437	492	657	712		139	210	353	495	567	638	852	924	
<b>700</b>	<b>180,61</b>	<b>205,52</b>	<b>255,43</b>	<b>305,31</b>	<b>330,25</b>	<b>355,20</b>	<b>430,03</b>	<b>455,98</b>		<b>212,52</b>	<b>241,46</b>	<b>300,33</b>	<b>359,19</b>	<b>388,12</b>	<b>417,06</b>	<b>504,85</b>	<b>534,81</b>	
W	124	187	315	442	506	569	760	824		159	240	403	566	648	730	974	1056	
<b>800</b>	<b>186,57</b>	<b>213,52</b>	<b>266,41</b>	<b>320,26</b>	<b>347,21</b>	<b>374,15</b>	<b>453,99</b>	<b>480,92</b>		<b>219,49</b>	<b>251,44</b>	<b>314,30</b>	<b>377,14</b>	<b>408,09</b>	<b>440,02</b>	<b>533,79</b>	<b>565,74</b>	
W	141	213	358	502	574	647	864	936		178	270	453	636	727	819	1094	1185	
<b>900</b>	<b>192,58</b>	<b>220,49</b>	<b>278,39</b>	<b>335,26</b>	<b>363,17</b>	<b>392,13</b>	<b>477,94</b>	<b>506,87</b>		<b>227,49</b>	<b>260,41</b>	<b>328,27</b>	<b>395,12</b>	<b>428,04</b>	<b>461,95</b>	<b>562,73</b>	<b>596,67</b>	
W	157	238	400	562	643	724	966	1047		197	298	501	704	805	906	1210	1312	
<b>1000</b>	<b>198,56</b>	<b>228,48</b>	<b>289,34</b>	<b>350,23</b>	<b>380,15</b>	<b>411,08</b>	<b>501,86</b>	<b>531,80</b>		<b>234,46</b>	<b>270,39</b>	<b>342,23</b>	<b>413,07</b>	<b>449,01</b>	<b>483,91</b>	<b>591,69</b>		
W	174	263	442	621	710	800	1068	1157		216	327	548	770	881	992	1324		
<b>1100</b>	<b>204,53</b>	<b>236,48</b>	<b>300,33</b>	<b>365,19</b>	<b>397,11</b>	<b>429,04</b>	<b>525,82</b>	<b>557,75</b>		<b>242,45</b>	<b>280,38</b>	<b>355,20</b>	<b>431,03</b>	<b>468,94</b>	<b>506,87</b>	<b>620,61</b>		
W	191	289	485	681	779	876	1170	1268		234	354	595	836	956	1076	1437		
<b>1200</b>	<b>210,54</b>	<b>244,45</b>	<b>312,30</b>	<b>379,16</b>	<b>413,07</b>	<b>446,98</b>	<b>548,78</b>	<b>582,70</b>		<b>249,45</b>	<b>289,34</b>	<b>369,17</b>	<b>449,01</b>	<b>488,89</b>	<b>528,81</b>	<b>648,55</b>		
W	207	314	527	740	846	953	1272	1379		252	382	641	900	1030	1159	1548		
<b>1400</b>	<b>222,52</b>	<b>259,41</b>	<b>334,23</b>	<b>409,09</b>	<b>446,98</b>	<b>483,91</b>	<b>596,67</b>	<b>633,56</b>		<b>264,42</b>	<b>308,32</b>	<b>397,11</b>	<b>485,90</b>	<b>529,81</b>	<b>573,71</b>	<b>706,43</b>		
W	240	364	611	858	982	1106	1476	1600		287	435	731	1026	1174	1321	1764		
<b>1600</b>	<b>234,46</b>	<b>275,37</b>	<b>357,19</b>	<b>439,02</b>	<b>479,94</b>	<b>520,84</b>	<b>643,55</b>	<b>685,46</b>		<b>279,38</b>	<b>328,27</b>	<b>425,05</b>	<b>521,84</b>	<b>569,72</b>	<b>618,60</b>	<b>764,29</b>		
W	274	414	695	977	1117	1258	1680	1820		322	487	818	1148	1314	1479	1975		
<b>1800</b>	<b>245,44</b>	<b>290,34</b>	<b>379,16</b>	<b>468,94</b>	<b>512,85</b>	<b>557,75</b>	<b>691,46</b>	<b>736,36</b>		<b>294,35</b>	<b>347,21</b>	<b>452,99</b>	<b>557,75</b>	<b>610,63</b>	<b>663,52</b>	<b>821,17</b>		
W	307	465	780	1095	1253	1411	1884	2041		355	538	903	1268	1450	1632	2180		
<b>2000</b>	<b>257,42</b>	<b>306,29</b>	<b>402,09</b>	<b>497,88</b>	<b>546,76</b>	<b>594,66</b>	<b>739,34</b>	<b>787,22</b>		<b>309,32</b>	<b>366,18</b>	<b>479,94</b>	<b>594,66</b>	<b>651,54</b>	<b>708,42</b>	<b>879,03</b>		
W	340	515	865	1215	1389	1564	2089	2264		388	587	985	1384	1583	1782	2380		

višina (mm)	KORATHERM VERTIKAL M - TIP 20								
	dolžina (mm)								
	144	218	366	514	588	662	884	958	
<b>500</b>	<b>280,50</b>	<b>321,92</b>	<b>404,75</b>	<b>486,63</b>	<b>528,05</b>	<b>569,46</b>	<b>693,73</b>	<b>735,15</b>	
W	137	207	348	489	559	630	841	911	
<b>600</b>	<b>291,80</b>	<b>336,98</b>	<b>426,40</b>	<b>515,82</b>	<b>561,00</b>	<b>605,24</b>	<b>739,84</b>	<b>785,02</b>	
W	161	244	410	576	659	742	991	1074	
<b>700</b>	<b>304,05</b>	<b>352,03</b>	<b>448,98</b>	<b>545,01</b>	<b>593,01</b>	<b>641,02</b>	<b>785,96</b>	<b>833,97</b>	
W	185	281	471	662	757	853	1139	1234	
<b>800</b>	<b>316,29</b>	<b>368,03</b>	<b>470,64</b>	<b>574,19</b>	<b>625,96</b>	<b>677,71</b>	<b>832,09</b>	<b>883,87</b>	
W	209	317	532	747	854	962	1284	1392	
<b>900</b>	<b>327,56</b>	<b>383,09</b>	<b>493,23</b>	<b>603,36</b>	<b>657,96</b>	<b>713,49</b>	<b>878,20</b>	<b>932,80</b>	
W	233	352	591	831	950	1070	1429	1548	
<b>1000</b>	<b>339,79</b>	<b>398,17</b>	<b>514,88</b>	<b>632,53</b>	<b>690,89</b>	<b>749,26</b>	<b>924,35</b>	<b>982,70</b>	
W	256	387	650	913	1045	1176	1571	1702	
<b>1100</b>	<b>352,03</b>	<b>414,17</b>	<b>537,47</b>	<b>660,78</b>	<b>722,91</b>	<b>785,02</b>	<b>970,45</b>	<b>1.032,58</b>	
W	279	422	709	996	1139	1282	1712	1856	
<b>1200</b>	<b>364,27</b>	<b>429,22</b>	<b>560,07</b>	<b>689,95</b>	<b>755,84</b>	<b>820,79</b>	<b>1.016,59</b>	<b>1.081,52</b>	
W	302	457	767	1077	1232	1387	1852	2007	
<b>1400</b>	<b>387,81</b>	<b>459,34</b>	<b>604,30</b>	<b>748,32</b>	<b>819,85</b>	<b>892,32</b>	<b>1.108,81</b>	<b>1.180,37</b>	
W	347	525	881	1237	1415	1593	2128	2306	
<b>1600</b>	<b>411,35</b>	<b>490,39</b>	<b>648,54</b>	<b>805,74</b>	<b>884,81</b>	<b>963,87</b>	<b>1.201,07</b>	<b>1.280,13</b>	
W	391	592	994	1396	1596	1797	2400	2601	
<b>1800</b>	<b>435,80</b>	<b>521,48</b>	<b>692,79</b>	<b>864,09</b>	<b>949,76</b>	<b>1.035,40</b>	<b>1.293,31</b>	<b>1.378,99</b>	
W	435	658	1105	1552	1775	1999	2669	2892	
<b>2000</b>	<b>459,34</b>	<b>551,59</b>	<b>737,03</b>	<b>922,47</b>	<b>1.014,69</b>	<b>1.106,93</b>	<b>1.385,57</b>		
W	478	724	1215	1706	1952	2198	2935		

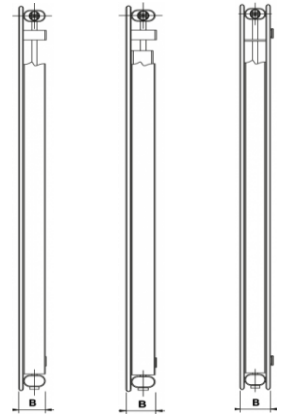
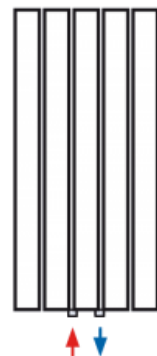
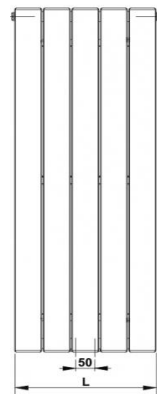

K10VM K11VM K20VM

SATIN GLOSS



HIGH GLOSS



MATTE



DEEP MATTE



BARVNA LESTVICA: Standardna površinska barva radiatorjev je bela RAL 9016.

Doplačilo 30% za drugo barvo s KORADO barvne lestvice (glej www.korado.si).

Doplačilo 40% za drugo barvo z RAL lestvice.

Po naročilu

## RADIATOR KORATHERM REFLEX Z OGLEDALOM



TIP 10



TIP 20



TIP 10



TIP 20

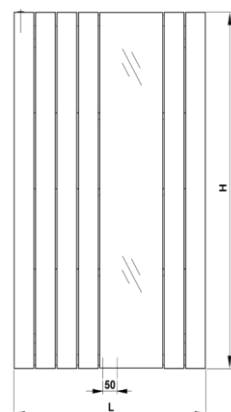

### VRSTE PRIKLOPA

#### REFLEX

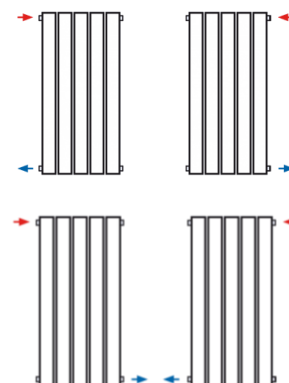

#### REFLEX-M

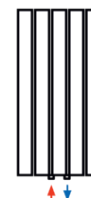

Režim ogrevanja 20°C:  
t1=70°C, t2=65°C

višina (mm)	TIP 10				TIP 20			
	dolžina (mm)				dolžina (mm)			
	514	662	810	958	514	662	884	958
1800	317,55	410,43	488,25	558,14	586,45	749,20	904,86	1.041,10
W	791	1086	1381	1676	1415	1877	2339	2811

**BARVNA LESTVICA:** Standardna površinska barva radiatorjev je bela RAL 9016. Doplačilo 30% za drugo barvo s KORADO barvne lestvice (glej [www.korado.si](http://www.korado.si)). Doplačilo 40% za drugo barvo z RAL lestvice.

#### SATIN GLOSS



#### HIGH GLOSS



#### MATTE



#### DEEP MATTE



## KORALUX NEO WHITE

Koda	EAN	Naziv	V(mm)	Š(mm)	d(mm)	W (Moč)	Cena
<b>KLN-110050-00-10</b>	8592651664301	KORALUX NEO 1100/0500	1095	496	50	520	<b>501,57</b>
<b>KLN-110060-00-10</b>	8592651664318	KORALUX NEO 1100/0600	1095	596	50	593	<b>559,24</b>
<b>KLN-142050-00-10</b>	8592651664325	KORALUX NEO 1420/0500	1415	496	50	670	<b>618,36</b>
<b>KLN-142060-00-10</b>	8592651664332	KORALUX NEO 1420/0600	1415	596	50	763	<b>676,02</b>
<b>KLN-170050-00-10</b>	8592651664349	KORALUX NEO 1700/0500	1695	496	50	803	<b>709,67</b>
<b>KLN-170060-00-10</b>	8592651664356	KORALUX NEO 1700/0600	1695	596	50	914	<b>769,15</b>

Režim ogrevanja 20°C: t1=75°C, t2=65°C

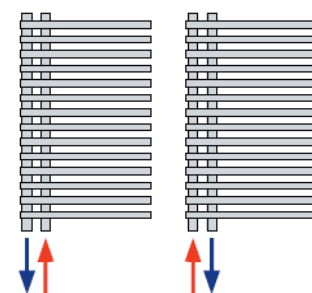
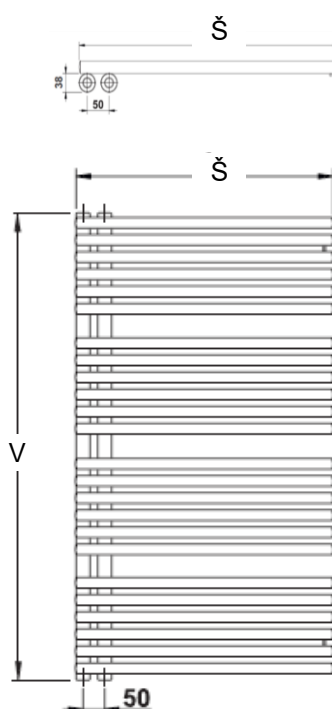

**PRIKLJUČKI: 4 x 1/2"**

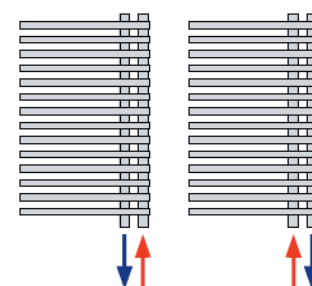

**BARVNA LESTVICA:** Standardna površinska barva radiatorjev je bela RAL 9016. Doplačilo 20% za drugo barvo s KORADO barvne lestvice (glej [www.korado.si](http://www.korado.si)). Doplačilo 30% za drugo barvo z RAL lestvice.

### SATIN GLOSS



### HIGH GLOSS



### MATTE



### DEEP MATTE



Režim ogrevanja 20°C: t1=75°C, t2=65°C

## KORALUX LINEAR COMFORT

Koda	Višina (h)	Širina (mm)	Moč (W)	Cena
KLT07000450-10	700	450	312	<b>109,56</b>
KLT07000500-10	700	500	342	<b>111,63</b>
KLT07000600-10	700	600	400	<b>115,17</b>
KLT07000750-10	700	750	485	<b>120,90</b>
KLT09000450-10	900	450	402	<b>124,81</b>
KLT09000500-10	900	500	440	<b>127,73</b>
KLT09000600-10	900	600	515	<b>132,86</b>
KLT09000750-10	900	750	624	<b>141,52</b>
KLT12200450-10	1220	450	549	<b>149,33</b>
KLT12200500-10	1220	500	601	<b>153,48</b>
KLT12200600-10	1220	600	703	<b>161,65</b>
KLT12200750-10	1220	750	852	<b>174,22</b>
KLT15000450-10	1500	450	682	<b>171,17</b>
KLT15000500-10	1500	500	747	<b>176,05</b>
KLT15000600-10	1500	600	874	<b>186,78</b>
KLT15000750-10	1500	750	1060	<b>202,89</b>
KLT18200450-10	1820	450	841	<b>195,44</b>
KLT18200500-10	1820	500	921	<b>202,28</b>
KLT18200600-10	1820	600	1078	<b>215,33</b>
KLT18200750-10	1820	750	1307	<b>235,46</b>

## KORALUX LINEAR COMFORT- M

Koda	Višina (h)	Širina (mm)	Moč (W)	Cena
KLT07000450M10	700	450	287	<b>146,03</b>
KLT07000500M10	700	500	315	<b>147,74</b>
KLT07000600M10	700	600	370	<b>151,28</b>
KLT07000750M10	700	750	450	<b>157,01</b>
KLT09000450M10	900	450	369	<b>161,04</b>
KLT09000500M10	900	500	405	<b>163,97</b>
KLT09000600M10	900	600	475	<b>169,09</b>
KLT09000750M10	900	750	579	<b>177,51</b>
KLT12200450M10	1220	450	504	<b>185,81</b>
KLT12200500M10	1220	500	553	<b>189,83</b>
KLT12200600M10	1220	600	650	<b>197,76</b>
KLT12200750M10	1220	750	791	<b>210,08</b>
KLT15000450M10	1500	450	626	<b>206,91</b>
KLT15000500M10	1500	500	687	<b>212,28</b>
KLT15000600M10	1500	600	808	<b>222,89</b>
KLT15000750M10	1500	750	984	<b>238,75</b>
KLT18200450M10	1820	450	772	<b>231,43</b>
KLT18200500M10	1820	500	848	<b>238,39</b>
KLT18200600M10	1820	600	996	<b>251,32</b>
KLT18200750M10	1820	750	1213	<b>271,57</b>

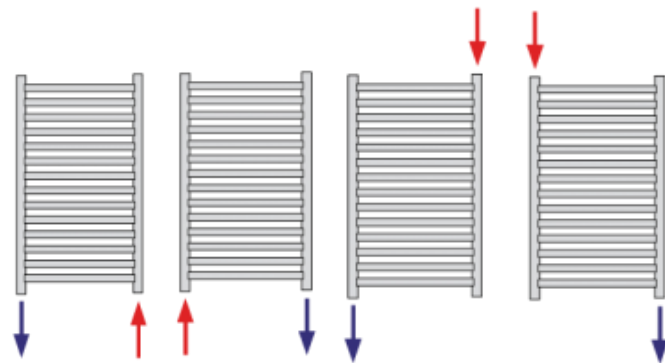

**BARVNA LESTVICA:** Standardna površinska barva radiatorjev je bela RAL 9016. Doplacilo 20% za drugo barvo s KORADO barvne lestvice (glej www.korado.si). Doplacilo 40% za drugo barvo z RAL lestvice.

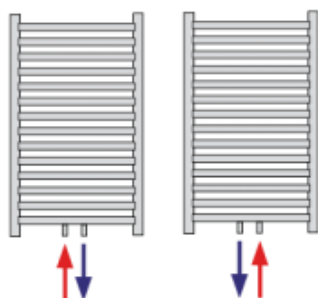



Režim ogrevanja 20°C: t1=75°C, t2=65°C

## KORALUX RONDO COMFORT

Koda	Višina (h)	Širina (mm)	Moč (W)	Cena
KRT07000450-10	700	450	312	<b>112,85</b>
KRT07000500-10	700	500	342	<b>114,68</b>
KRT07000600-10	700	600	400	<b>118,46</b>
KRT07000750-10	700	750	485	<b>124,32</b>
KRT09000450-10	900	450	402	<b>128,71</b>
KRT09000500-10	900	500	440	<b>131,39</b>
KRT09000600-10	900	600	515	<b>136,88</b>
KRT09000750-10	900	750	624	<b>145,55</b>
KRT12200450-10	1220	450	549	<b>153,96</b>
KRT12200500-10	1220	500	601	<b>157,99</b>
KRT12200600-10	1220	600	703	<b>166,53</b>
KRT12200750-10	1220	750	852	<b>179,34</b>
KRT15000450-10	1500	450	682	<b>175,92</b>
KRT15000500-10	1500	500	747	<b>181,54</b>
KRT15000600-10	1500	600	874	<b>192,15</b>
KRT15000750-10	1500	750	1060	<b>208,74</b>
KRT18200450-10	1820	450	841	<b>201,30</b>
KRT18200500-10	1820	500	921	<b>208,01</b>
KRT18200600-10	1820	600	1078	<b>221,55</b>
KRT18200750-10	1820	750	1307	<b>242,41</b>

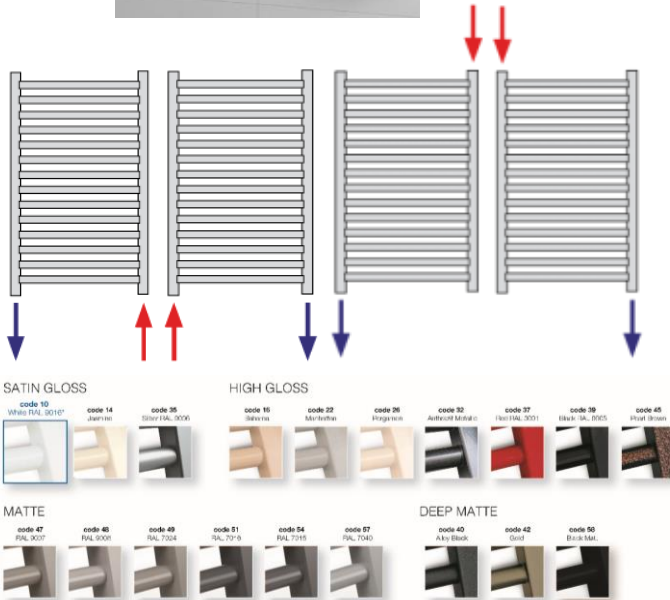

**BARVNA LESTVICA:** Standardna površinska barva radiatorjev je bela RAL 9016. Doplacilo 20% za drugo barvo s KORADO barvne lestvice (glej www.korado.si). Doplacilo 40% za drugo barvo z RAL lestvice.

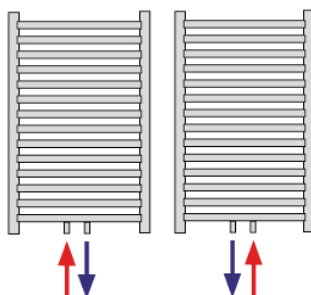

## KORALUX RONDO COMFORT- M

Koda	Višina (h)	Širina (mm)	Moč (W)	Cena
KRT07000450M10	700	450	287	<b>149,08</b>
KRT07000500M10	700	500	315	<b>150,79</b>
KRT07000600M10	700	600	370	<b>154,57</b>
KRT07000750M10	700	750	450	<b>160,43</b>
KRT09000450M10	900	450	369	<b>164,94</b>
KRT09000500M10	900	500	405	<b>167,51</b>
KRT09000600M10	900	600	475	<b>173,00</b>
KRT09000750M10	900	750	579	<b>181,66</b>
KRT12200450M10	1220	450	504	<b>190,08</b>
KRT12200500M10	1220	500	553	<b>194,47</b>
KRT12200600M10	1220	600	650	<b>202,89</b>
KRT12200750M10	1220	750	791	<b>215,45</b>
KRT15000450M10	1500	450	626	<b>212,28</b>
KRT15000500M10	1500	500	687	<b>217,53</b>
KRT15000600M10	1500	600	808	<b>228,26</b>
KRT15000750M10	1500	750	984	<b>244,98</b>
KRT18200450M10	1820	450	772	<b>237,29</b>
KRT18200500M10	1820	500	848	<b>244,12</b>
KRT18200600M10	1820	600	996	<b>257,79</b>
KRT18200750M10	1820	750	1213	<b>278,53</b>

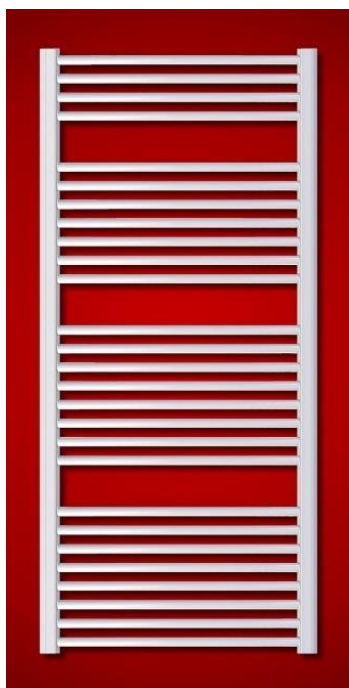

## KOPALNIŠKI RADIATORJI LINEAR P.THERMAL

Koda	Višina (mm)	Širina (mm)	Moč (W)	Cena
<b>9242</b>	940	500	733	<b>100,41</b>
<b>9244</b>	940	600	948	<b>107,12</b>
<b>9246</b>	940	750	1157	<b>118,46</b>
<b>9254</b>	1220	500	1086	<b>120,54</b>
<b>9256</b>	1220	600	1409	<b>129,20</b>
<b>9258</b>	1220	750	1729	<b>139,93</b>
<b>9266</b>	1500	500	1086	<b>141,64</b>
<b>9268</b>	1500	600	1409	<b>145,67</b>
<b>9270</b>	1500	750	1729	<b>160,80</b>
<b>9278</b>	1820	500	1086	<b>157,62</b>
<b>9280</b>	1820	600	1409	<b>170,92</b>
<b>9282</b>	1820	750	1728	<b>192,88</b>



## KOPALNIŠKI RADIATORJI RONDO P.THERMAL

Koda	Višina (mm)	Širina (mm)	Moč (W)	Cena
<b>9243</b>	940	500	538	<b>101,87</b>
<b>9245</b>	940	600	704	<b>110,41</b>
<b>9247</b>	940	750	896	<b>121,76</b>
<b>9255</b>	1220	500	699	<b>125,42</b>
<b>9257</b>	1220	600	824	<b>134,44</b>
<b>9259</b>	1220	750	1011	<b>145,55</b>
<b>9267</b>	1500	500	869	<b>147,38</b>
<b>9269</b>	1500	600	1025	<b>151,40</b>
<b>9271</b>	1500	750	1256	<b>167,26</b>
<b>9279</b>	1820	500	1078	<b>164,09</b>
<b>9281</b>	1820	600	1274	<b>178,61</b>
<b>9283</b>	1820	750	1567	<b>198,74</b>

## TERMOSTATSKI VENTIL M (sredinski priklp) RAVNI

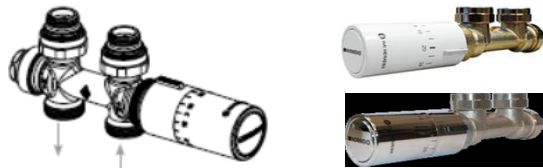

Koda	EAN	Naziv	Cena
<b>Z-D040</b>	8592651664530	beli	<b>175,77</b>
<b>Z-D041</b>		krom	<b>211,87</b>

## TERMOSTATSKI VENTIL M (sredinski priklp) KOTNI

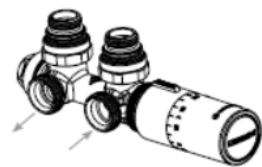

Koda	EAN	Naziv	Cena
<b>Z-D042</b>	8592651664578	beli	<b>175,77</b>
<b>Z-D043</b>		krom	<b>211,87</b>

## POKROV ZA TERMOSTATSKI VENTIL M



Koda	EAN	Naziv	Cena
<b>Z-D027</b>	8590822372222	Pokrov bel	<b>8,91</b>
<b>Z-D028</b>	8590822372239	Pokrov krom	<b>25,46</b>

## T-KOS za glavo radiatorja



Koda	EAN	Naziv	Cena
<b>Z-SKV-0001</b>	8590822992147	T-kos	<b>9,71</b>

## REGULATOR TEMPERATURE RE10A



Koda	EAN	Cena
<b>Z-SKV-0004</b>	8590822831484	<b>66,50</b>

## VTIČ ZA EL. GRELEC z ročnim stikalom



Koda	EAN	Cena
<b>Z-SKV-0002</b>	8590822992154	<b>8,92</b>

## ELEKTRIČNI GRELEC ZA RADIATORJE oglati bel



Koda	Naziv	Cena
<b>GL01.300WH</b>	Električni grelec 300W - 1/2"- bel	<b>73,20</b>
<b>GL01.600WH</b>	Električni grelec 600W - 1/2"- bel	<b>75,64</b>
<b>GL01.900WH</b>	Električni grelec 900W - 1/2"- bel	<b>78,08</b>

## ELEKTRIČNI GRELEC ZA RADIATORJE oglati črn



Koda	Naziv	Cena
<b>GL01.300BK</b>	Električni grelec 300W - 1/2"- črn	<b>76,86</b>
<b>GL01.600BK</b>	Električni grelec 600W - 1/2"- črn	<b>79,30</b>
<b>GL01.900BK</b>	Električni grelec 900W - 1/2"- črn	<b>81,74</b>

## ELEKTRIČNI GRELEC ZA RADIATORJE oglati krom



Koda	Naziv	Cena
<b>GL01.300CH</b>	Električni grelec 300W - 1/2"- krom	<b>76,86</b>
<b>GL01.600CH</b>	Električni grelec 600W - 1/2"- krom	<b>76,86</b>
<b>GL01.900CH</b>	Električni grelec 900W - 1/2"- krom	<b>78,08</b>

## ELEKTRIČNI GRELEC ZA RADIATORJE okrogli bel



Koda	Naziv	Cena
<b>GL02.300WH</b>	Električni grelec 300W - 1/2"- bel	<b>73,20</b>
<b>GL02.600WH</b>	Električni grelec 600W - 1/2"- bel	<b>75,64</b>
<b>GL02.900WH</b>	Električni grelec 900W - 1/2"- bel	<b>78,08</b>

## RADIATORSKE KONZOLE C stenska montaža

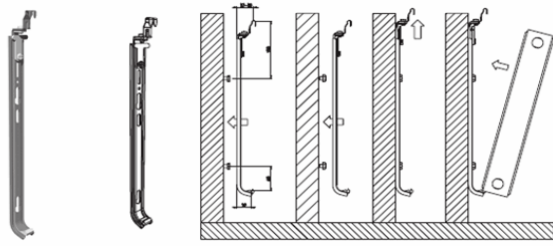

Koda	Koda P.	EAN	Dimenzije (mm)	Pakiranje	Cena
<b>C-300</b>	<b>1501</b>	3830016901513	300	2 kosa	<b>7,93</b>
<b>C-400</b>	<b>1502</b>		400	2 kosa	<b>8,05</b>
<b>C-500</b>	<b>1503</b>		500	2 kosa	<b>8,30</b>
<b>C-600</b>	<b>1500</b>	3830016901506	600	2 kosa	<b>8,60</b>
<b>C-700</b>	<b>1505</b>		700	2 kosa	<b>9,15</b>
<b>C-900</b>	<b>1504</b>	3830016901544	900	2 kosa	<b>9,33</b>

Konzola za vse tipe radiatorjev brez ušesc, konzola drži zgornji in spodnji rob radiatorja preko rešetke. V kompletu 2x konzola, 2x sidni vložek Ø10, 2x vijak M8 x 70.

## RADIATORSKE KONZOLE H stenska montaža

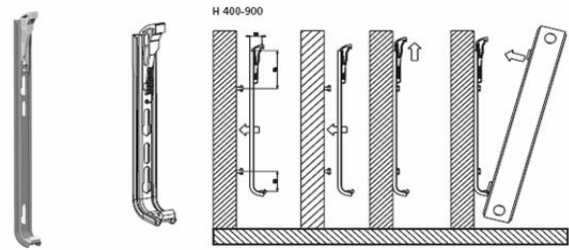

Koda	Koda P.	EAN	Dimenzije (mm)	Pakiranje	Cena
<b>H-300ko</b>	<b>1010</b>		300	2 kosa	<b>7,50</b>
<b>H-400ko</b>	<b>1011</b>		400	2 kosa	<b>7,63</b>
<b>H-500ko</b>	<b>1012</b>	3830016900264	500	2 kosa	<b>7,75</b>
<b>H-600ko</b>	<b>1013</b>		600	2 kosa	<b>7,99</b>
<b>H-900ko</b>	<b>1014</b>	3830016900288	900	2 kosa	<b>8,72</b>

Konzola za vse tipe radiatorjev z ušesci, plastično držalo se ob pritisku radiatorja samodejno zaskoči, v kompletu 2x konzola, 2x sidni vložek Ø10 in 2x vijak M8 x 70.

## RADIATORSKE KONZOLE TH talna montaža

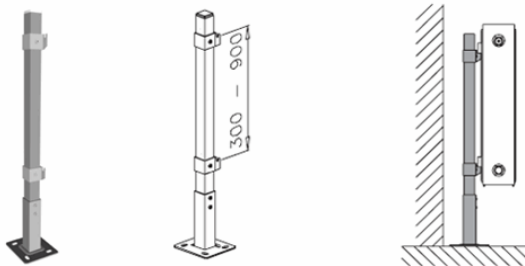

Koda	Koda P.	EAN	Pakiranje	Cena / kos
<b>TH-300</b>	<b>1123</b>		1	<b>16,29</b>
<b>TH-500</b>	<b>1124</b>		1	<b>17,14</b>
<b>TH-600</b>	<b>1125</b>		1	<b>18,18</b>
<b>TH-900</b>	<b>1126</b>		1	<b>20,62</b>

Konzola za talno montažo za vse tipe in znamke radiatorjev, ki imajo na zadnji strani privarjena ušesa. V kompletu: 1x konzola, 2x sidni vložek, 2x vijak M8x60.

## RADIATORSKE KONZOLE T talna montaža

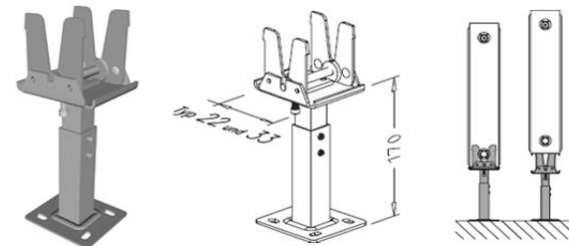

Koda	Koda P.	EAN	Pakiranje	Cena / kos
<b>T-2</b>	<b>1121</b>	3830016911215	1 kos	<b>23,85</b>

Konzola za talno montažo za tip 22 in 33. V kompletu 4x sidni vložek, 4x vijak M8x60

## OBEŠALA ZA BRISAČE

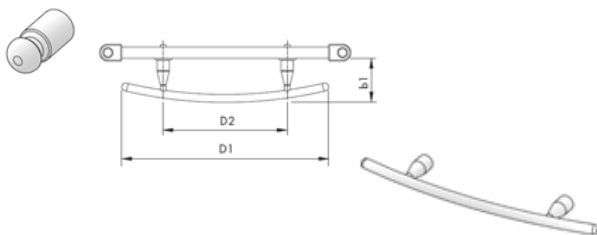

Koda	EAN		Cena
<b>Z-D035</b>	8590822837363	Koratherm - 370mm	<b>106,15</b>
<b>Z-D036</b>	8590822837370	Koratherm - 518mm	<b>113,35</b>
<b>Z-D038</b>	8590822837394	Koratherm - kljukica	<b>26,74</b>

Za vse modele KORALUX razen STANDARD.

## ROZETA PVC ENOJNA



Koda	EAN	Ø(mm)		Cena
<b>384006015</b>	8595609115283	D15	bela	<b>0,415</b>
<b>384006018</b>	8595609115306	D18	bela	<b>0,415</b>
<b>384006022</b>	8595609115320	D22	bela	<b>0,336</b>
<b>384006215</b>	8595609115368	D15	krom	<b>1,086</b>
<b>384006218</b>	8595609115382	D18	krom	<b>1,122</b>
<b>384006222</b>	8595609115405	D22	krom	<b>1,501</b>
<b>384006228</b>	8595609115429	D23	krom	<b>1,501</b>



## RADIATORSKI HOLANDEC RAVNI

Koda	EAN	Cena
<b>92160400160</b>	4260175473139	<b>6,94</b>

Radiatorski holandec ravni črni 1/2"

<b>92160410160</b>	4260175474808	<b>6,94</b>
--------------------	---------------	-------------

Radiatorski holandec ravni črni 3/8"



## RADIATORSKI HOLANDEC KOTNI

Koda	EAN	Cena
<b>92160400159</b>	4260175473122	<b>6,94</b>

Radiatorski holandec kotni črni 1/2"

<b>92160410159</b>	4260175473146	<b>6,94</b>
--------------------	---------------	-------------

Radiatorski holandec kotni črni 3/8"



## RADIATORSKI HOLANDEC RAVNI Cu

Koda	EAN	Cena
<b>92160408160</b>	4260477953186	<b>7,16</b>

CU radiatorski holandec ravni 1/2"



## RADIATORSKI HOLANDEC KOTNI Cu

Koda	EAN	Cena
<b>92160408159</b>	4260477953179	<b>7,16</b>

CU radiatorski holandec kotni 1/2"



## TERMOSTATSKI VENTIL RAVNI

Koda	EAN	Cena
<b>90481500521</b>	4260175470473	<b>11,22</b>

Termostatski radiatorski ventil ravni črni 1/2"

<b>90481000521</b>	4260175470466	<b>10,65</b>
--------------------	---------------	--------------

Termostatski radiatorski ventil ravni črni 3/8"



## TERMOSTATSKI VENTIL KOTNI

Koda	EAN	Cena
<b>90481570521</b>	4260175470442	<b>11,22</b>

Termostatski radiatorski ventil kotni črni 1/2"

<b>90481070521</b>	4260175470435	<b>10,65</b>
--------------------	---------------	--------------

Termostatski radiatorski ventil kotni črni 3/8"



## TERMOSTATSKI VENTIL RAVNI Cu

Koda	EAN	Cena
<b>90481500522</b>	4260175473764	<b>10,27</b>

CU radiatorski termostatski ventil ravni 1/2"



## TERMOSTATSKI VENTIL KOTNI Cu

Koda	EAN	Cena
<b>90481570522</b>	4260175473757	<b>10,27</b>

CU radiatorski termostatski ventil kotni 1/2"



## RADIATORSKI ADAPTER

Koda	EAN	Cena
<b>82811500002</b>	4260175470794	<b>1,06</b>

Radiatorski adapter



## ODZRAČEVALNIK

Koda	EAN	Cena
<b>91170400164</b>	4260477955678	<b>7,43</b>

Ročni odzračevalnik za razdelilce



## ODZRAČEVALNI LONČEK

Koda	EAN	Cena
<b>40101500002</b>	4260477955241	<b>10,81</b>

Avtomatski odzračevalni lonček



## EUROKONUS

Koda	EAN	Cena
<b>82501602208</b>	4260175470824	<b>1,92</b>

Eurokonus 16 x 2 ALUM/PEX



## TERMOSTATSKA GLAVA

Koda	EAN	Cena
<b>93911100000</b>	4260477955609	<b>11,16</b>

Termostatska glava



Krogelni ventil se dobavi posebej.

## RAZDELILCI za talno ogrevanje

Koda	EAN	Naziv	Cena
70200200201	4260175479711	Razdelilec 2 veji	100,92
70200300201	4260477955586	Razdelilec 3 veje	124,14
70200400201	4260477955593	Razdelilec 4 veje	157,48
70200500201	4260477955609	Razdelilec 5 vej	181,29
70200600201	4260477955616	Razdelilec 6 vej	205,40
70200700201	4260477955623	Razdelilec 7 vej	227,42
70200800201	4260477955630	Razdelilec 8 vej	248,86
70200900201	4260477955647	Razdelilec 9 vej	270,29
702001000201	4260477955654	Razdelilec 10 vej	291,73
702001100201	4260477955661	Razdelilec 11 vej	312,56
702001200201	4260175478219	Razdelilec 12 vej	342,93



## RAZDELILCI PLASTIČNI za talno ogrevanje

Koda	EAN	Naziv	Cena
MLK00002010		Razdelilec MULTIKAL plastični 2 veji	148,22
MLK00003010		Razdelilec MULTIKAL plastični 3 veje	177,75
MLK00004010		Razdelilec MULTIKAL plastični 4 veje	203,41
MLK00005010		Razdelilec MULTIKAL plastični 5 vej	235,09
MLK00006010		Razdelilec MULTIKAL plastični 6 vej	261,76
MLK00007010		Razdelilec MULTIKAL plastični 7 vej	298,17
MLK00008010		Razdelilec MULTIKAL plastični 8 vej	324,83
MLK00009010		Razdelilec MULTIKAL plastični 9 vej	347,19
MLK00010010		Razdelilec MULTIKAL plastični 10 vej	369,84
MLK00011010		Razdelilec MULTIKAL plastični 11 vej	401,95
MLK00012010		Razdelilec MULTIKAL plastični 12 vej	435,78



### MANOMETER

Koda	EAN	Cena
ACC00000352		22,57

Manometer za tlačni test razdelilca



### MAGNETNI FILTER

Koda	EAN	Cena
DEF00000003		103,58

Magnetni filter 1" z ventilom



### TERMOSTATSKI VENTIL

Koda	EAN	Cena
90612525005	4260477953643	31,35

Ventil za razdelilec s termometrom ravni rdeč 1"



### TERMOSTATSKI VENTIL

Koda	EAN	Cena
90612525002	4260175472552	31,35

Ventil za razdelilec s termometrom ravni moder 1"



### VENTIL ZA RAZDELILEC

Koda	EAN	Cena
90612525008	4260175478417	20,13

Ventil za razdelilec ravni rdeč 1"



### VENTIL ZA RAZDELILEC

Koda	EAN	Cena
90612525009	4260175478400	20,13

Ventil za razdelilec ravni moder 1"



### VENTIL ZA RAZDELILEC

Koda	EAN	Cena
90612525001	4260175478431	22,81

Ventil za razdelilec kotni rdeč 1"



### VENTIL ZA RAZDELILEC

Koda	EAN	Cena
90612525003	4260175478424	22,81

Ventil za razdelilec kotni moder 1"



### EUROKONUS

Koda	EAN	Cena
82501602208	4260175470824	1,92

Eurokonus 16 x 2 ALUM/PEX

## RAZDELILNE OMARICE PODOMETNE z zapahom za talno ogrevanje



NOVO

Koda	Naziv	Cena
<b>ECO-MW0335Z</b>	Omarica razdelilna podometna ECO-0 / 2 veji, nastavljiva	<b>50,51</b>
<b>ECO-MW0435Z</b>	Omarica razdelilna podometna ECO-1 / 2-4 veje, nastavljiva	<b>62,50</b>
<b>ECO-MW0565Z</b>	Omarica razdelilna podometna ECO-2 / 5-8 vej, nastavljiva	<b>67,88</b>
<b>ECO-MW0715Z</b>	Omarica razdelilna podometna ECO-3 / 8-10 vej, nastavljiva	<b>75,16</b>
<b>ECO-MW0795Z</b>	Omarica razdelilna podometna ECO-4 / 10-12 vej, nastavljiva	<b>82,01</b>
<b>ECO-MW0965Z</b>	Omarica razdelilna podometna ECO-5 / 12-14 vej, nastavljiva	<b>100,08</b>
<b>ECO-MW1140Z</b>	Omarica razdelilna podometna ECO-6 / 14-16 vej, nastavljiva	<b>114,18</b>

<b>ECO-ADAPT0400Z</b>	Omarica razdelilna podometna ADAPT-1 / 2-4 veje, premična stranica	<b>73,63</b>
<b>ECO-ADAPT0600Z</b>	Omarica razdelilna podometna ADAPT-2 / 5-8 vej, premična stranica	<b>86,99</b>
<b>ECO-ADAPT0800Z</b>	Omarica razdelilna podometna ADAPT-3 / 8-10 vej, premična stranica	<b>102,97</b>
<b>ECO-ADAPT1000Z</b>	Omarica razdelilna podometna ADAPT-4 / 10-12 vej, premična stranica	<b>129,63</b>
<b>ECO-ADAPT1200Z</b>	Omarica razdelilna podometna ADAPT-5 / 12-14 vej, premična stranica	<b>152,56</b>

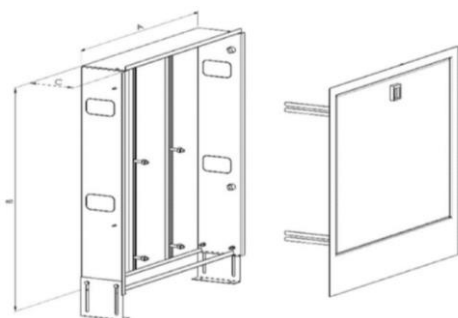

A	B	C	Dimenzije z embalažo (mm)	Neto teža (kg)
335	575 - 665	110 - 170	390 / 605 / 115	5,120
435	575 - 665	110 - 170	490 / 605 / 115	5,600
565	575 - 665	110 - 170	620 / 605 / 115	6,325
715	575 - 665	110 - 170	770 / 605 / 115	7,800
795	575 - 665	110 - 170	850 / 605 / 115	8,540
965	575 - 665	110 - 170	1020 / 605 / 115	10,000



## CEVI za talno ogrevanje

Koda	Naziv	V kolotu (m)	Cena / m
<b>MULTIC.16-R200</b>	IST cev alumplast 16 x 2	200	<b>1,31</b>
<b>MULTIC.16-R450</b>	IST cev alumplast 16 x 2	450	<b>1,31</b>



## PLOŠČE za talno ogrevanje

Koda	Naziv	Dimenzije (cm)	Cena / m <sup>2</sup>
<b>2592016</b>	Plošča za talno ogrevanje 3,5cm	138 x 69 x 3,5	<b>12,44</b>
<b>2592017</b>	Plošča za talno ogrevanje 4,5cm	138 x 69 x 4,5	<b>16,84</b>
<b>2592018</b>	Plošča za talno ogrevanje 5cm	138 x 69 x 5,5	<b>19,28</b>
<b>2592020</b>	Plošča za talno ogrevanje brez izolacije	138 x 69 x 3,7	<b>10,00</b>

## OBJEMKE ZA FIKSIRANJE DOVODNIH CEVI za talno ogrevanje

Koda	Naziv		Cena
<b>384182595</b>	Objemka za fiksiranje dovodnih cevi N1 x 25 - 8/75	enojna	<b>0,32</b>
<b>384183295</b>	Objemka za fiksiranje dovodnih cevi N1 x 32 - 8/75	enojna	<b>0,37</b>
<b>384283295</b>	Objemka za fiksiranje dovodnih cevi N2 x 32 - 8/75	dvojna	<b>0,60</b>

## SKOBE za talno ogrevanje

Koda	Naziv	Pakirano kosc	kos	Cena
<b>390000305</b>	Skoba za talno ogrevanje tip C ročna	50	1	<b>0,23</b>
<b>390000307</b>	Skoba za talno ogrevanje tip D za tacker	200	1	<b>0,22</b>
<b>390000310</b>	Tacker - pritrdilec za skobe			<b>296,75</b>





## TOPLOVODNI KALORIFER VOLCANO VR MINI

Koda	Naziv		Pretok zraka (m³/h)	Cena
1-4-0101-0455	<b>VOLCANO VR MINI EC</b>	Konzole v ceni. Dimenzije: 530x530mm, globina 300mm (s konzolo 517mm)	2100	<b>390,40</b>
1-4-0101-0445	<b>VOLCANO VR MINI AC</b>	Konzole v ceni. Dimenzije: 530x530mm, globina 310mm (s konzolo 517mm)	2100	<b>362,34</b>
1-4-0101-0624	<b>VOLCANO VR MINI 3 EC</b>	Konzole v ceni. Dimenzije: 530x530mm, globina 300mm (s konzolo 517mm)	2000	<b>488,00</b>
1-4-0101-0498	<b>VOLCANO VR-D MINI EC DESTRATIFIKATOR</b>	Konzole v ceni. Dimenzije: 530x530mm, globina 300mm (s konzolo 517mm)	2330	<b>337,94</b>

## TOPLOVODNI KALORIFER VOLCANO VR1

Koda	Naziv		Pretok zraka (m³/h)	Cena
1-4-0101-0442	<b>VOLCANO VR1 EC</b>	Konzole v ceni. Dimenzije: 700x700mm, globina 350mm (s konzolo 610mm)	5300	<b>567,30</b>
1-4-0101-0446	<b>VOLCANO VR1 AC</b>	Konzole v ceni. Dimenzije: 700x700mm, globina 355mm (s konzolo 610mm)	5300	<b>523,38</b>

## TOPLOVODNI KALORIFER VOLCANO VR2

Koda	Naziv		Pretok zraka (m³/h)	Cena
1-4-0101-0443	<b>VOLCANO VR2 EC</b>	Konzole v ceni. Dimenzije: 700x700mm, globina 350mm (s konzolo 610mm)	4850	<b>624,64</b>
1-4-0101-0444	<b>VOLCANO VR2 AC</b>	Konzole v ceni. Dimenzije: 700x700mm, globina 355mm (s konzolo 610mm)	4850	<b>575,84</b>

## TOPLOVODNI KALORIFER VOLCANO VR3

Koda	Naziv		Pretok zraka (m³/h)	Cena
1-4-0101-0444	<b>VOLCANO VR3 EC</b>	Konzole v ceni. Dimenzije: 700x700mm, globina 350mm (s konzolo 610mm)	5700	<b>705,16</b>
1-4-0101-0445	<b>VOLCANO VR3 AC</b>	Konzole v ceni. Dimenzije: 700x700mm, globina 355mm (s konzolo 610mm)	5700	<b>650,26</b>

## TOPLOVODNI KALORIFER VOLCANO VR4

Koda	Naziv		Pretok zraka (m³/h)	Cena
1-4-0101-0626	<b>VOLCANO VR4 EC</b>	Konzole v ceni. Dimenzije: 700x700mm, globina 350mm (s konzolo 610 mm)	5300	<b>882,06</b>

## TOPLOVODNI KALORIFER VOLCANO VR-D destratifikator

Koda	Naziv		Pretok zraka (m³/h)	Cena
1-4-0101-0440	<b>VOLCANO VR-D EC</b>	Konzole v ceni. Dimenzije: 700x700mm, globina 350mm (s konzolo 610 mm)	6500	<b>502,64</b>
1-4-0101-0449	<b>VOLCANO VR-D AC</b>	Konzole v ceni. Dimenzije: 700x700mm, globina 355mm (s konzolo 610 mm)	6500	<b>469,70</b>

TEHNIČNI PODATKI		VR Mini AC/EC	VR Mini 3 AC/EC	VR-D Mini AC/EC	VR1 AC/EC	VR2 AC/EC	VR3 AC/EC	VR4 AC/EC	VR-D AC/EC
Razpon ogrevalne moči	kW	3-20	2-27	-	5-30	8-50	13-75	10-90	-
Maksimalni pretok zraka	m³/h	2100	2000	2330	5300	4850	5700	5300	6500
Horizontalni doseg (maks.)	m	14	14	16	23	22	25	23	28
Vertikalni doseg (maks.)	m	8	8	10	12	11	12	12	15
El. moč AC motorja	W	115	115	115	280	280	410	320	410
El. moč EC motorja	W	95	95	95	250	250	370	285	370
Poraba el. energije	W	91	91	-	202	226	355	123	-
Raven hrupa AC motorja	dB	52	52	49	56	56	57	56	58
Raven hrupa EC motorja	dB	50	50	50	54	54	55	54	56



## Število priključenih kaloriferjev na model regulacije

Koda	Naziv	VR Mini AC/EC	VR Mini 3 AC/EC	VR-D Mini AC/EC	VR1 AC/EC	VR2 AC/EC	VR3 AC/EC	VR4 AC/EC	VR-D AC/EC
<b>1-4-0101-0438</b>	Regulacija WING / VOLCANO (ACmotor)	4	4	1	2	2	1	1	1
<b>1-4-0101-0434</b>	Regulator hitrosti ARW 3,0/2	4	4	1	1	1	1	1	1
<b>1-4-0101-0038</b>	Regulacija WING / VOLCANO (AC motor)	1	1	1	1	1	1	1	1
<b>1-4-0101-0167</b>	Regulator hitrosti ARW 0,6/1	1	1	0	0	0	0	0	0
<b>1-4-0101-0453</b>	Potenciometer VR EC (0-10V)	8	8	8	8	8	8	8	8
<b>1-4-0101-0473</b>	Potenciometer s termostatom 0-10V	8	8	8	8	8	8	8	8
<b>1-4-0101-0457</b>	Regulator Volcano HMI (0-10V) EC	8	8	8	8	8	8	8	8

## OPREMA ZA TOPLOVODNE KALORIFERJE VOLCANO

Koda	Naziv	Cena
<b>1-4-0101-0158</b>	Regulator Volcano HMI Wi-fi (0 - 10V) za EC motorje	<b>129,32</b>
<b>1-4-0101-0457</b>	Regulator Volcano HMI (0 - 10V) za EC motorje	<b>95,16</b>

Koda	Naziv	Cena
<b>1-4-0101-0438</b>	Regulacija WING / VOLCANO (za AC motorje)	<b>29,28</b>
Dovoljena obremenitev: 1A za 230VAC0, 02A za 0-10V. Temperaturno območje: 10...30°C. Razred zaščite: IP30		

<b>1-4-0101-0434</b>	Regulator hitrosti ARW 3,0/2 (IP54)	<b>95,16</b>
<b>1-4-0101-0167</b>	Regulator hitrosti ARW 0,6/1 (IP54)	<b>51,24</b>
Avtoregulator, ročno upravljanje, prilagajanje hitrosti 5 stopenj.		

Koda	Naziv	Cena
<b>1-4-0101-0038</b>	Termostat VR (IP30)	<b>17,08</b>
Ločeni kontrolni izhodi za ogrevanje (Volcano konvektorji) in funkcijo hlajenja (Volcano VR-D konvektorji)		

Koda	Naziv	Cena
<b>1-4-0101-0453</b>	Potenciometer VR EC (0-10V)	<b>34,16</b>
<b>1-4-0101-0473</b>	Potenciometer VR EC (0-10V) s termostatom	<b>43,92</b>

Koda	Naziv	Cena
<b>1-2-1205-0007</b>	Sobni senzor NTC za HMI 0457 regulacijo	<b>29,28</b>
<b>1-2-1205-0008</b>	Sobni senzor NTC	<b>21,96</b>

Koda	Naziv	Cena
<b>1-2-0393-1978</b>	Nadometna doza za HMI (kovinska)	<b>13,66</b>

Koda	Naziv	Cena
<b>1-2-1204-2019</b>	Ventil z motornim pogonom VA-VEH202TA	<b>75,64</b>

Koda	Naziv	Cena
<b>1-2-2702-0076</b>	Priključne cevi 3/4" - (d=0,6 / 0,9m)	<b>28,06</b>

Koda	Naziv	Cena
<b>1-5-2701-4021</b>	Lovilec kondenza za VR Mini-VR Mini3	<b>28,06</b>
<b>1-5-2701-4019</b>	Lovilec kondenza za VR1 - VR4	<b>49,17</b>



## VODNA ZRAČNA ZAVESA WING II W za ogrevanje



### Z AC motorjem

Koda	Naziv	Dolžina (cm)	Pretok (m³/h)	Cena
1-4-2801-0250	WING II W100 (AC)	100	bela 1850	<b>623,42</b>
1-4-2801-0251	WING II W150 (AC)	150	bela 3100	<b>736,88</b>
1-4-2801-0252	WING II W250 (AC)	200	bela 4400	<b>916,22</b>

### Z EC motorjem

Koda	Naziv	Dolžina (cm)	Pretok (m³/h)	Cena
1-4-2801-0259	WING II W100 (EC)	100	bela 1850	<b>689,30</b>
1-4-2801-0260	WING II W150 (EC)	150	bela 3100	<b>854,00</b>
1-4-2801-0261	WING II W200 (EC)	200	bela 4400	<b>1.054,08</b>
1-4-2801-0308	WING II W100 (EC)	100	siva 1850	<b>689,30</b>
1-4-2801-0309	WING II W150 (EC)	150	siva 3100	<b>854,00</b>
1-4-2801-0310	WING II W200 (EC)	200	siva 4400	<b>1.054,08</b>

## ELEKTRO ZRAČNA ZAVESA WING II E za ogrevanje



### Z AC motorjem

Koda	Naziv	Dolžina (cm)	Pretok (m³/h)	Cena
1-4-2801-0253	WING II E100 (AC)	100	bela 1850	<b>620,98</b>
1-4-2801-0254	WING II E150 (AC)	150	bela 3150	<b>732,00</b>
1-4-2801-0255	WING II E200 (AC)	200	bela 4500	<b>912,56</b>

### Z EC motorjem

Koda	Naziv	Dolžina (cm)	Pretok (m³/h)	Cena
1-4-2801-0262	WING II E100 (EC)	100	bela 1850	<b>685,64</b>
1-4-2801-0263	WING II E150 (EC)	150	bela 3150	<b>850,34</b>
1-4-2801-0264	WING II E200 (EC)	200	bela 4500	<b>1.051,64</b>
1-4-2801-0311	WING II E100 (EC)	100	siva 1850	<b>685,64</b>
1-4-2801-0312	WING II E150 (EC)	150	siva 3150	<b>850,34</b>
1-4-2801-0313	WING II E200 (EC)	200	siva 4500	<b>1.051,64</b>

## HLADILNA ZRAČNA ZAVESA WING II C za hlajenje



### Z AC motorjem

Koda	Naziv	Dolžina (cm)	Pretok (m³/h)	Cena
1-4-2801-0256	WING II C100 (AC)	100	bela 1950	<b>522,16</b>
1-4-2801-0257	WING II C150 (AC)	150	bela 3200	<b>639,28</b>
1-4-2801-0258	WING II C200 (AC)	200	bela 4600	<b>823,50</b>

### Z EC motorjem

Koda	Naziv	Dolžina (cm)	Pretok (m³/h)	Cena
1-4-2801-0265	WING II C100 (EC)	100	bela 1950	<b>570,96</b>
1-4-2801-0266	WING II C150 (EC)	150	bela 3200	<b>744,20</b>
1-4-2801-0267	WING II C200 (EC)	200	bela 4600	<b>906,46</b>
1-4-2801-0314	WING II C100 (EC)	100	siva 1950	<b>570,96</b>
1-4-2801-0315	WING II C150 (EC)	150	siva 3200	<b>744,20</b>
1-4-2801-0316	WING II C200 (EC)	200	siva 4600	<b>906,46</b>

## INDUSTRIJSKA ZRAČNA ZAVESA WING PRO



### HLADILNA ZRAČNA ZAVESA

Koda	Naziv	Pretok (m³/h)	Cena
1-4-2801-0347	WING PRO C150 (EC)	8500	1.122,40
1-4-2801-0353	WING PRO C200 (EC)	12800	1.483,52

### VODNA ZRAČNA ZAVESA Z ENIM TOPLOTNIM IZMENJEVALCEM

Koda	Naziv	Pretok (m³/h)	Cena
1-4-2801-0348	WING PRO W150 R1 (EC) - 1 topl.izm.	7900	1.338,34
1-4-2801-0354	WING PRO W200 R1 (EC) - 1 topl.izm.	11900	1.737,28

### VODNA ZRAČNA ZAVESA Z DVEMA TOPLOTNIMA IZMENJEVALCEMA

Koda	Naziv	Pretok (m³/h)	Cena
1-4-2801-0349	WING PRO W150 R2 (EC) - 2 topl. izm.	7300	1.411,54
1-4-2801-0355	WING PRO W200 R2 (EC) - 2 topl. izm.	10700	1.847,08

## OPREMA ZA ZRAČNE ZAVESE



## KONZOLE ZA ZRAČNE ZAVESE

Koda	Naziv	Cena
1-4-2801-0053	Konzole za WING 100	24,40
1-4-2801-0054	Konzole za WING 150/200	32,94
1-4-2801-0180	Konzole za zračno zaveso WING II 100	24,40
1-4-2801-0181	Konzole za zračno zaveso WING II 150/200	36,60
1-4-2801-0317	Konzole za zračno zaveso WING II 100 (RAL 7016)	24,40
1-4-2801-0318	Konzole za zračno zaveso WING II 150/200 (RAL 7016)	36,60



## REGULACIJA ZA ZRAČNE ZAVESE

Koda	Naziv	Cena
1-4-2801-0156	Regulacija HMI WING EC (0 - 10V) Wi-fi za EC motorje	129,32
1-4-2801-0155	Regulacija HMI WING EC (0-10V (za EC motorje)	111,02
1-4-0101-0438	Regulacija WING / VOLCANO (za AC motorje)	29,28

Dovoljena obremenitev: 1A za 230VAC0, 02A za 0-10V. Temperaturno območje: 5...40°C. Razred zaščite: IP20

Dovoljena obremenitev: 1A za 230VAC0, 02A za 0-10V. Temperaturno območje: 10...30°C. Razred zaščite: IP30



Koda	Naziv	Cena
1-4-0101-0454	Senzor vrat (magnet) REED WING EC	24,40

Switching current: 500mA. Switching voltage: max 200V. Connection: screw.



Koda	Naziv	Cena
1-2-1204-2019	Ventil z motornim pogonom VA-VEH202TA	75,64

Napajalna napetost: ~230V/1ph/50Hz. Čas odpiranja: 3/3min. Kvs:4,5. Razred zaščite: IP54



Koda	Naziv	Cena
1-2-2702-0076	Priključne cevi 3/4" - (d=0,6 / 0,9m)	28,06

Dolžina: 0,6 - 0,9m. Priključek: GW 3/4". Plak max.:1,6 Mpa. Min. delovna temp. voda: 5°C. Min. delovna temp. (glikol): -20°C. Max. delovna temp.130°C. V setu: cev 2 x, tesnilo 4x.

TEHNIČNE LASTNOSTI WING II W		WING II W100 (AC)	WING II W100 (EC)	WING II W150 (AC)	WING II W150 (EC)	WING II W200 (AC)	WING II W200 (EC)
Koda	bela	1-4-2801-0250	1-4-2801-0259	1-4-2801-0251	1-4-2801-0260	1-4-2801-0252	1-4-2801-0261
	siva		1-4-2801-0308		1-4-2801-0309		1-4-2801-0310
Max. širina vrat na 1 zračno zaveso	m	1		1,5		2	
Max. višina vrat (vert.postavitev)	m	3,7					
Max. pretok zraka	m³/h	1850		3100		4400	
Ogrevalna moč	kW	4 - 17		10 - 32		17 - 47	
Max. temp. ogrevne vode	°C	95					
Max. delovni tlak	Mpa	1,6					
Volumen vode	dm³	1,6		2,6		3,6	
Število spiral topl.izmenjevalca	kos	2					
Premer cevnega priključka	"						
Napetost	V/pH/Hz	~230/1/50					
Moč električnega grelca	kW						
Nazivni tok električnega grelca	A						
Moč motorja	kW	0,235	0,2	0,375	0,3	0,58	0,47
Nazivni tok EC motorja	A	1,2	1,1	1,7	1,3	2,6	1,9
Teža	kg	20,8	21,2	27,8	24,5	34,6	30,4
Razred zaščite	IP	20					

TEHNIČNE LASTNOSTI WING II E		WING II E100 (AC)	WING II E100 (EC)	WING II E150 (AC)	WING II E150 (EC)	WING II E200 (AC)	WING II E200 (EC)
Koda	bela	1-4-2801-0253	1-4-2801-0262	1-4-2801-0254	1-4-2801-0263	1-4-2801-0255	1-4-2801-0264
	siva		1-4-2801-0311		1-4-2801-0312		1-4-2801-0313
Max. širina vrat na 1 zračno zaveso	m	1		1,5		2	
Max. višina vrat (vert.postavitev)	m	3,7					
Max. pretok zraka	m³/h	1850		3150		4500	
Ogrevalna moč	kW	2 ali 4/6		8/12		10/15	
Max. temp. ogrevne vode	°C						
Max. delovni tlak	Mpa						
Volumen vode	dm³						
Število spiral topl.izmenjevalca	kos						
Premer cevnega priključka	"						
Napetost	V/pH/Hz	~230/1/50 za 2kW, ~400/3/50 za 4/6kW		~400/3/50		~400/3/50	
Moč električnega grelca	kW	2 in 4		4 in 8		8 in 12	
Nazivni tok električnega grelca	A	6 / max.9		11,5 / max.17,3		14,5 / max.21,4	
Moč motorja	kW	0,235	0,2	0,375	0,3	0,58	0,47
Nazivni tok EC motorja	A	1,2	1,1	1,7	1,3	2,6	1,9
Teža	kg	20	17,3	26,8	23,4	33,3	29,1
Razred zaščite	IP	20					

TEHNIČNE LASTNOSTI WING II C		WING II C100 (AC)	WING II C100 (EC)	WING II C150 (AC)	WING II C150 (EC)	WING II C200 (AC)	WING II C200 (EC)
Koda	bela	1-4-2801-0256	1-4-2801-0265	1-4-2801-0257	1-4-2801-0266	1-4-2801-0258	1-4-2801-0267
	siva		1-4-2801-0314		1-4-2801-0315		1-4-2801-0316
Max. širina vrat na 1 zračno zaveso	m	1		1,5		2	
Max. višina vrat (vert.postavitev)	m	4					
Max. pretok zraka	m³/h	1950		3200		4600	
Ogrevalna moč	kW						
Max. temp. ogrevne vode	°C						
Max. delovni tlak	Mpa						
Volumen vode	dm³						
Število spiral topl.izmenjevalca	kos						
Premer cevnega priključka	"						
Napetost	V/pH/Hz	~230/1/50					
Moč električnega grelca	kW						
Moč motorja	kW	0,235	0,2	0,375	0,3	0,58	0,47
Nazivni tok EC motorja	A	1,2	1,1	1,7	1,3	2,6	1,9
Teža	kg	17,9	15,3	23,8	20,4	29,3	25,1
Razred zaščite	IP	20					

TEHNIČNE LASTNOSTI WING PRO		WING PRO W150 R2 (EC)	WING PRO W200 R2 (EC)	WING PRO W150 R1 (EC)	WING PRO W200 R1 (EC)	WING PRO C150 (EC)	WING PRO C200 (EC)
Koda	bela	1-4-2801-0349	1-4-2801-0355	1-4-2801-0348	1-4-2801-0354	1-4-2801-0347	1-4-2801-0353
	siva						
Max. višina vrat	m	1,5	2	1,5	2	1,5	2
Doseg zračnega toka	m	7		7,5		8	
Max. pretok zraka	m³/h	7300	10700	7900	11900	8500	12800
Ogrevalna moč	kW	17-58	28-88	3-32	15-48		
Max. temp. ogrevne vode	°C	130					
Max. delovni tlak	Mpa	1,6					
Premer cevnega priključka	"	3/4"					
Napetost	V/pH/Hz	~230/1/50					
Moč EC motorja	kW	2 x 0,25	3 x 0,25	2 x 0,25	3 x 0,25	2 x 0,25	3 x 0,25
Nazivni tok EC motorja	A	2 x 1,3	3 x 1,3	2 x 1,3	3 x 1,3	2 x 1,3	3 x 1,3
Teža (brez vode)	kg	53,6	69,6	50,5	66,1	43,4	58,3
Razred zaščite	IP	54					
Dimenzije	mm	1556 x 536 x 530	2072 x 536 x 530	1556 x 536 x 530	2072 x 536 x 530	1556 x 536 x 530	2072 x 536 x 530

## LOKALNA REKUPERACIJA

## LOKALNI REKUPERATOR z daljinskim upravljalnikom

Koda	EAN	Naziv	Pretok	Cena
<b>004388</b>	8058647113852	Quantum NEXT 100	25/21/17/14/10 m³/h	<b>425,78</b>
<b>003015</b>	8058647113494	Quantum NEXT 150	60/50/40/30/20 m³/h	<b>431,88</b>



Dodatne opcije:		Naziv	Cena
<b>000971*</b>	8058647114125	Zunanja rešetka TRM 100 PRO	<b>63,44</b>
<b>000972</b>	8058647114132	Zunanja rešetka TRM 150 PRO	<b>68,32</b>
<b>005095</b>		Zunanja protihrupna rešetka TRM 150 ISO	<b>80,52</b>
<b>004635</b>		Teleskopska cev ø100 dolž.300/570mm	<b>10,49</b>
<b>000456</b>		Teleskopska cev ø150 dolž.300/570mm	<b>13,54</b>



000971



005095



000456

Quantum NEXT je samostojna decentralizirana prezračevalna rekuperacijska naprava, namenjena zagotavljanju zadostnega prezračevanja zaprtih prostorov z minimalno izgubo toplotne energije. Priporočljiva je vgradnja dveh naprav, povezanih v par; ena enota dovaja svež zrak, druga enota odvaja obstoječi zrak iz prostora in obratno. Par enot se lahko namesti v en prostor ali v različne prostore (kot dnevna soba in spalnica). S tem dosežemo večje kroženje zraka oz. prezračenos stanovanja ali poslovnega prostora. Enota je namenjena za vgradnjo na zunanjo steno. Daljinski upravljalnik ima funkcije: način pretoka zraka (izmenični, vpih, izpih), način brez hlajenja, 5 stopenj stalne hitrosti, povečanje hitrosti, OFF-izklop, ponastavitev filtrov.

## LOKALNI REKUPERATOR s 3-stopenjskim stikalom

Koda	EAN	Naziv	Pretok	Cena
<b>000468</b>	8058647113869	Quantum HR 100	25/15/10 m³/h	<b>248,88</b>
<b>000470</b>	8058647113876	Quantum HR 150	60/40/20 m³/h	<b>280,60</b>



V ceni je zajeto:

<b>000596</b>	8058647114781	3-stopenjsko podometno stikalo CTRL-S	v ceni
<b>000597</b>	8058647114774	3-stopenjsko nadometno stikalo CTRL-S	v ceni

Dodatne opcije:

<b>PTM00001</b>	8058647113982	Stikalo s timerjem	<b>82,59</b>
<b>003688</b>	8058647113944	Stikalo s senzorjem za regulacijo vlage SEN-HY	<b>108,34</b>
<b>CCM00001</b>		Stikalo s senzorjem CO2	<b>353,80</b>
<b>003692</b>	8058647113968	Stikalo s senzorjem prisotnosti SRL	<b>141,15</b>
<b>001548</b>	8058647114750	KT100HR zapora za lokalni rekuperator, ø100	<b>5,61</b>
<b>001549</b>	8058647114767	KT150HR zapora za lokalni rekuperator, ø150	<b>5,61</b>
<b>000456</b>		Teleskopska cev ø150 dolž.300/570mm črna	<b>13,54</b>



PTM00001



003688



CCM00001



003692



001548



000456

Quantum HR je samostojna decentralizirana prezračevalna rekuperacijska naprava za zagotavljanje zadostnega prezračevanja zaprtih prostorov z minimalno izgubo toplotne energije. Priporočljiva je vgradnja dveh povezanih naprav; ena enota dovaja svež zrak, druga enota odvaja obstoječi zrak iz prostora in obratno. Par enot se lahko namesti v en prostor ali v različne prostore. Enota je namenjena za vgradnjo na zunanjo steno.

## ENOSMERNNA DECENTRALIZIRANA MEHANSKA PREZRAČEVALNA ENOTA za neprekinjeno delovanje

Koda	*Oprodaja	EAN	Naziv	Cena
<b>004635</b>		8058647114002	Quantum MX 100HT, časovnik, senzor vlage	<b>156,16</b>
<b>004664*</b>		8058647113920	Quantum AX 150HT Timer, 2 hitrosti, senzor vlage	<b>180,56</b>
<b>003686</b>			Zunanja rešetka EG150, za Quantum AX in QR100	<b>7,08</b>



Naprava je idealna za uporabo v kopalnici, stranišču in majhnih do srednje velikih prostorih. Primerno za odsesavanje zraka neposredno na zunanjo stran ali s kratkimi vodi. Enota se lahko namesti na steno, strop ali okno. Enota je opremljena s senzorjem vlage na pokrovu (nastavljiv od 50% do 95% RH) in časovnikom (nastavljiv od ± 0' do 30'). Delovanje: kadar je odstotek relativne vlage višji od predhodno nastavljenih vrednosti, ventilator samodejno poveča hitrost. Ko se relativna vlaga spusti pod nastavljen vrednostjo, ventilator ponovno preklopi v osnovno hitrost, z nastavljenim časovnim zamikom. Največjo hitrost lahko aktivirate ročno preko stikala ali (opcijsko) z vlečno vrvico.

# Podatkovni list : Evropska direktiva – ErP, Uredbe 1253/2014-1254/2014

## LOKALNE REKUPERACIJSKE NAPRAVE

a) Blagovna znamka

AERAULIQA

b) Oznaka modela	QUANTUM NEXT 100	QUANTUM NEXT 150	QUANTUM HR 100	QUANTUM HR 150	QUANTUM AX 150 HT	QUANTUM MX 100
c) Razred SEC	A	A	A	A	C	C
c1) Razred SEC toplo podnebje kWh/m <sup>2</sup>	-17	-18	-15,6	-16,2	-11,3	-10,8
c2) Razred SEC zmerno podnebje kWh/m <sup>2</sup>	-40,6	-41,6	-37,5	-38,2	-25,5	-25,2
c3) Razred SEC hladno podnebje kWh/m <sup>2</sup>	-81,8	-82,8	-75,6	-76,4	-50,6	-50,3
Energijska nalepka	Da	Da	Da	Da	Ne	Ne
d) Tip naprave	Stanovanjska - dvosmerna		Stanovanjska - dvosmerna		Stanovanjska - dvosmerna	
e) Vrsta pogona	Večstopenjski pogon		Večstopenjski pogon		Večstopenjski pogon	
f) Vrsta sistema za rekuperacijo toplote	Rekuperacija		Rekuperacija			
g) Toplotni izkoristek za rekuperacijo toplote %	74	74	74	74	N/A	N/A
h) Največja stopnja pretoka pri 100Pa m <sup>3</sup> /h	25	60	25	60	195	100
i) Vhodna el. moč pogona ventilatorja pri max. pretoku W	3,5	6	6	6	6,5	5
j) Nivo zvokovne moči dBA	39	40	35	38	56	43
k) Referenčna stopnja pretoka m <sup>3</sup> /h	18	41	17	41	195	72
l) Referenčna tlačna razlika Pa	10	10	10	10	10	10
m) Specifična vhodna moč W/m <sup>3</sup> /h	0,139	0,08	0,071	0,054	0,035	0,057
n1) Regulacijski faktor	0,65	0,65	1	1	0,65	0,65
n2) Vrsta regulacije	Lokalni nadzor		Ročno krmiljenje (ni DCV)		Lokalni nadzor	
o1) Deklarirana najvišja stopnja notranjega puščanja %	N/A	N/A	N/A	N/A	N/A	N/A
o2) Deklarirana najvišja stopnja zunanjega puščanja %	1	1	1	1	N/A	2
p1) Stopnja notranjega mešanja %	N/A	N/A	N/A	N/A	N/A	N/A
p2) Stopnja zunanjega mešanja %	N/A	N/A	N/A	N/A	N/A	N/A
q) Položaj in opis vidnega opozorila za filter	Rumena led		N/A	N/A	N/A	N/A
r) Navodila za namestitev regulirne rešetke	N/A	N/A	N/A	N/A	priložena navodila	
s) Internetni naslov z navodili za montažo						
t) Občutljivost pretoka zraka na spremembe tlaka %	N/A	N/A	N/A	N/A	N/A	N/A
u) Notranja / zunanja zračna tesnost m <sup>3</sup> /h	18	50	21	60	132	52
v1) Letna poraba električne energije - toplo podnebje AEC kWh	1	0,6	1	0,7	0,3	0,4
v2) Letna poraba električne energije - povprečno podnebje AEC kWh	1	0,6	1	0,7	0,3	0,4
v3) Letna poraba električne energije - hladno podnebje AEC kWh	1	0,6	1	0,7	0,3	0,4
w1) Prihranjeno letno ogrevanje - toplo podnebje AEC kWh	19,5	19,5	18	18,1	11,9	11,9
w2) Prihranjeno letno ogrevanje - povprečna klima AEC kWh	43,1	43,2	39,9	40	26,2	26,2
w3) Prihranjeno letno ogrevanje - hladno podnebje AEC kWh	84,3	84,3	78	78,2	51,3	51,3
Pretok zraka pri različnih hitrostih m <sup>3</sup> /h	25/21/17/14/10	60/50/40/30/20	25/15/10	60/40/20	max 187; min 29	max 90; min 15
Poraba energije pri različni hitrosti W	3,5 / 3 / 2,5 / 2 / 2	6 / 4,5 / 3,5 / 2,5 / 2	2,6/1,7/1,2	3,8/2,3/1,4	max 6,5; min 1,0	max 5; min 1,5
Glasnost pri 3m (1) pri različni hitrosti dB (A)	27/23/18/14/9	29/24/20/14/10	29/15/10	26/18/10	max 35; min < 9	max 32; min < 9
Toplotni izkoristek za rekuperacijo toplote %	70/72/74/78/82	70/72/74/78/82	70/74,3/82	70/74,3/82		
Temperatura prostora max. °C	-20°C ÷ +50°C	-20°C ÷ +50°C	-20°C ÷ +50°C	-20°C ÷ +50°C	50	40
Stopnja zaščite IP	X4	X4	X4	X4	X4	X4

Označevanje / Oznaka

220-240V ~ 50Hz



Type Approved  
Seguridad  
Regular Production  
Surveillance  
www.tuv.com  
ID: 0217007721

Zmogljivost zraka, izmerjena po ISO 5801 a 230V 50Hz, gostota zraka 1,2 kg/m<sup>3</sup>.

Podatki so izmerjeni v priznanem laboratoriju TÜV Rheinland v Aerauliqua glede na Tehnični list IEC OD 2048 (level CTF1) za IEC 60335-1 in IEC 60335-2-80 Standard.

(1) Zvočna obremenitev pri 3m v prostem polju, prebji, pri 40% hitrosti, samo za primerjalne namene.

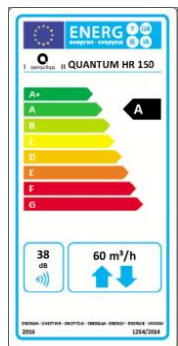
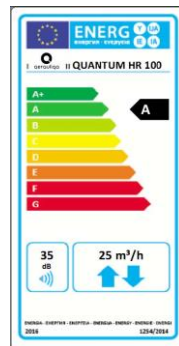
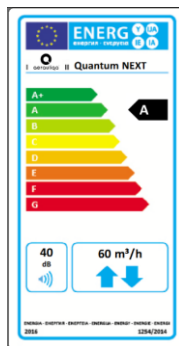

## CENTRALNA REKUPERACIJA

## REKUPERACIJSKE NAPRAVE QR z avtomatskim bypasom

Centralne prezračevalne naprave so namenjene za neprekinjen odvzem toplote (QR550A) vlažnega zraka, odvzetega iz vlažnih prostorov, in dogrevanje svežega zraka, ki je speljan v bivalne prostore. Enostaven sistem za vsak prostor zagotavlja pravilno prezračevanje - hitro črpanje povečane ravni vlage ali onesnaženega zraka. Predhodno ogrevanje / ohlajanje svežega zraka zmanjša potrebo po dodatnem ogrevanju oz. klimatizaciji. EC krtačni motorji bistveno zmanjšajo porabo električne energije. Pravilno vzdrževani filtri preprečujejo vstop cvetnega prahu v prostor.



Koda	EAN	Naziv	Cena
<b>004922</b>	8058647114903	QR120P centralna prezračevalna naprava 102m <sup>3</sup> /h SLIM LINE	<b>1.266,36</b>



Koda	EAN	Naziv	Cena
<b>001266</b>	8058647114422	QR180ABP centralna prezračevalna naprava 177m <sup>3</sup> /h z avtomatskim bypasom	<b>1.893,44</b>



Koda	EAN	Naziv	Cena
<b>003217</b>	8058647114439	QR280ABP centralna prezračevalna naprava 256m <sup>3</sup> /h z avtomatskim bypasom	<b>2.002,02</b>



Koda	EAN	Naziv	Cena
<b>005292</b>		QR340A centralna prezračevalna naprava 300m <sup>3</sup> /h z avtomatskim bypasom	<b>2.083,76</b>



Koda	EAN	Naziv	Cena
<b>003696</b>	8058647114453	QR400ABP centralna prezračevalna naprava 363m <sup>3</sup> /h z avtomatskim bypasom	<b>2.677,90</b>



Koda	EAN	Naziv	Cena
<b>001016</b>	8058647114484	QR550ABP centralna prezračevalna naprava 520m <sup>3</sup> /h z avtomatskim bypasom	<b>2.793,80</b>



Koda	EAN	Naziv	Cena
<b>QREL1K</b>		Elektrorelec 1 kW za predgretje	<b>731,02</b>

# Podatkovni list : Evropska direktiva – ErP, Uredbe 1253/2014-1254/2014

## CENTRALNE REKUPERACIJSKE NAPRAVE

a) Blagovna znamka

b) Oznaka modela

c) Razred SEC

c1) Razred SEC toplo podnebje

c2) Razred SEC zmerno podnebje

c3) Razred SEC hladno podnebje

Energjska nalepka

d) Tip naprave

e) Vrsta pogona

f) Vrsta sistema za rekuperacijo toplote

g) Toplotni izkoristek za rekuperacijo toplote

h) Največja stopnja pretoka pri 100Pa

i) Vhodna el. moč pogona ventilatorja pri max. pretoku

j) Nivo zvokovne moči

k) Referenčna stopnja pretoka

l) Referenčna tlačna razlika

m) Specifična vhodna moč

n1) Regulačijski faktor

n2) Vrsta regulacije

o1) Deklarirana najvišja stopnja notranjega puščanja

o2) Deklarirana najvišja stopnja zunanjega puščanja

p1) Notranja hitrost mešanja

p2) Zunanja hitrost mešanja

q) Položaj in opis vidnega opozorila za filter

r) Navodila za namestitvev regulirne rešetke

s) Internetni naslov z navodili za montažo

t) Občutljivost pretoka zraka na spremembe tlaka

u) Notranja / zunanja zračna tesnost

v1) Letna poraba električne energije - toplo podnebje AEC

v2) Letna poraba električne energije - povprečno podnebje AEC

v3) Letna poraba električne energije - hladno podnebje AEC

w1) Prihranjeno letno ogrevanje - toplo podnebje AEC

w2) Prihranjeno letno ogrevanje - povprečna klima AEC

w3) Prihranjeno letno ogrevanje - hladno podnebje AEC

Glasnost pri 3m (1) pri različni hitrosti

Temperatura prostora max.

Stopnja zaščite IP

Označevanje / Oznaka

220-240V ~ 50Hz

Zmogljivost zraka, izmerjena po ISO 5801 a 230V 50Hz, gostota zraka 1,2 kg/m<sup>3</sup>.

Podatki so izmerjeni v priznanem laboratoriju TÜV Rheinland v Aerauliki glede na Tehnični list IEC OD 2048 (level CTF1) za IEC 60335-1 in IEC 60335-2-80 Standard.

(1) Zvočna obremenitev pri 3m v prostem polju, preboj, pri 40% hitrosti, samo za primerjalne namene

### AERAULIKA

		QR120P			QR180A			QR280A		
		A	A	B	A	A	A	A	A	B
c1) Razred SEC toplo podnebje	kWh/m <sup>2</sup>	-14,7	-11,3	-8,5	-15,0	-10,6	-6,7	-15,2	-11,0	-7,2
c2) Razred SEC zmerno podnebje	kWh/m <sup>2</sup>	-39,5	-35,5	-31,8	-39,4	-34,3	-29,9	-39,3	-34,4	-30,1
c3) Razred SEC hladno podnebje	kWh/m <sup>2</sup>	-82,8	-77,7	-67,8	-77,3	-71,1	-65,9	-76,8	-70,7	-65,5
Energjska nalepka		Da			Da			Da		
d) Tip naprave		Stanovanjska - dvosmerna			Stanovanjska - dvosmerna			Stanovanjska - dvosmerna		
e) Vrsta pogona		Večstopenjski pogon			Večstopenjski pogon			Večstopenjski pogon		
f) Vrsta sistema za rekuperacijo toplote		Rekuperacija			Rekuperacija			Rekuperacija		
g) Toplotni izkoristek za rekuperacijo toplote	%	82			82			80		
h) Največja stopnja pretoka pri 100Pa	m <sup>3</sup> /h	102			177			256		
i) Vhodna el. moč pogona ventilatorja pri max. pretoku	W	58			105			105		
j) Nivo zvokovne moči	dBA	50			50			56		
k) Referenčna stopnja pretoka	m <sup>3</sup> /h	71			124			179		
l) Referenčna tlačna razlika	Pa	50			50			50		
m) Specifična vhodna moč	W/m <sup>3</sup> /h	0,352			0,412			0,385		
n1) Regulačijski faktor		0,65	0,85	1,0	0,65	0,85	1,0	0,65	0,85	1,0
n2) Vrsta regulacije		Lokalni nadzor	Centralni nadzor	Ročni nadzor (ni DCV)	Lokalni nadzor	Centralni nadzor	Ročni nadzor (ni DCV)	Lokalni nadzor	Centralni nadzor	Ročni nadzor (ni DCV)
o1) Deklarirana najvišja stopnja notranjega puščanja	%	2			2,5			1,5		
o2) Deklarirana najvišja stopnja zunanjega puščanja	%	1			1			1,5		
p1) Notranja hitrost mešanja	%	N/A			N/A			N/A		
p2) Zunanja hitrost mešanja	%	N/A			N/A			N/A		
q) Položaj in opis vidnega opozorila za filter		vidno opozorilo			vidno opozorilo			vidno opozorilo		
r) Navodila za namestitvev regulirne rešetke		N/A			N/A			N/A		
s) Internetni naslov z navodili za montažo										
t) Občutljivost pretoka zraka na spremembe tlaka		N/A			N/A			N/A		
u) Notranja / zunanja zračna tesnost	m <sup>3</sup> /h	N/A			N/A			N/A		
v1) Letna poraba električne energije - toplo podnebje AEC	kWh	2,3	3,5	4,4	2,2	3,7	5,2	2	3,5	4,8
v2) Letna poraba električne energije - povprečno podnebje AEC	kWh	2,3	3,5	4,9	2,6	4,2	5,6	2,5	3,9	5,3
v3) Letna poraba električne energije - hladno podnebje AEC	kWh	2,3	3,5	10,2	8,0	9,6	11,0	7,9	9,3	10,7
w1) Prihranjeno letno ogrevanje - toplo podnebje AEC	kWh	20,5	20	19,6	20,5	19,9	19,6	20,3	19,7	19,3
w2) Prihranjeno letno ogrevanje - povprečna klima AEC	kWh	45,3	44,1	43,3	45,3	44,1	43,2	44,9	43,6	42,6
w3) Prihranjeno letno ogrevanje - hladno podnebje AEC	kWh	88,6	86,3	84,6	88,5	86,3	84,6	87,8	85,3	83,4
Glasnost pri 3m (1) pri različni hitrosti	dB (A)	18			21			21		
Temperatura prostora max.	°C	+40			+40			+40		
Stopnja zaščite IP		X4			X4			X4		



CE

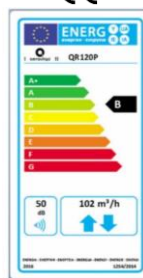

CE

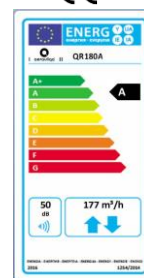

CE

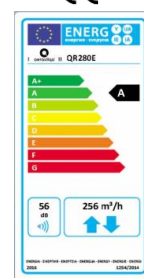

## TEHNIČNI OPIS

### QR120P

Teža 11,5 kg

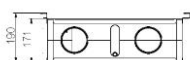
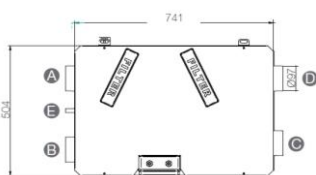

### QR180A

Teža 20kg

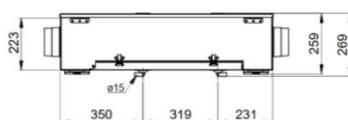
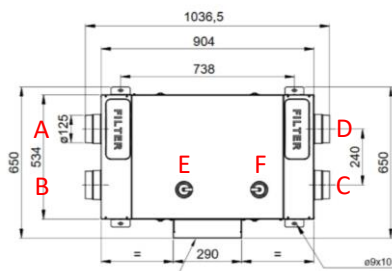

### QR280A

Teža 21kg

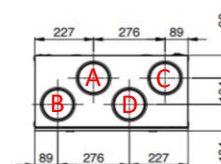
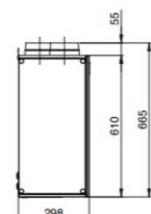
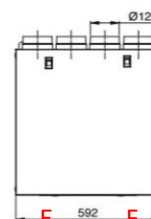

- A Zunanji zajem zraka
- B Izpust zunanji
- C Dovod zraka v prostor
- D Odvzem zraka iz prostora
- E Odvod kondenza - zima
- F Odvod kondenza - poletje



# Podatkovni list : Evropska direktiva – ErP, Uredbe 1253/2014-1254/2014

## CENTRALNE REKUPERACIJSKE NAPRAVE

a) Blagovna znamka

b) Oznaka modela

c) Razred SEC

c1) Razred SEC toplo podnebje

c2) Razred SEC zmerno podnebje

c3) Razred SEC hladno podnebje

Energijska nalepka

d) Tip naprave

e) Vrsta pogona

f) Vrsta sistema za rekuperacijo toplote

g) Toplotni izkoristek za rekuperacijo toplote

h) Največja stopnja pretoka pri 100Pa

i) Vhodna el. moč pogona ventilatorja pri max. pretoku

j) Nivo zvokovne moči

k) Referenčna stopnja pretoka

l) Referenčna tlačna razlika

m) Specifična vhodna moč

n1) Regulacijski faktor

n2) Vrsta regulacije

o1) Deklarirana najvišja stopnja notranjega puščanja

o2) Deklarirana najvišja stopnja zunanega puščanja

p1) Notranja hitrost mešanja

p2) Zunanja hitrost mešanja

q) Položaj in opis vidnega opozorila za filter

r) Navodila za namestitvev regulirne rešetke

s) Internetni naslov z navodili za montažo

t) Občutljivost pretoka zraka na spremembe tlaka

u) Notranja / zunanja zračna tesnost

v1) Letna poraba električne energije - toplo podnebje AEC

v2) Letna poraba električne energije - povprečno podnebje AEC

v3) Letna poraba električne energije - hladno podnebje AEC

w1) Prihranjeno letno ogrevanje - toplo podnebje AEC

w2) Prihranjeno letno ogrevanje - povprečna klima AEC

w3) Prihranjeno letno ogrevanje - hladno podnebje AEC

Glasnost pri 3m (1) pri različni hitrosti

Temperatura prostora max.

Stopnja zaščite IP

Označevanje / Oznaka

220-240V ~ 50Hz

Zmogljivost zraka, izmerjena po ISO 5801 a 230V 50Hz,

gostota zraka 1,2 kg/m<sup>3</sup>.

Podatki so izmerjeni v priznanem laboratoriju TÜV Rheinland v Aerauliq glede na Tehnični list IEC OD 2048 (level CTF1) za IEC 60335-1 in IEC 60335-2-80 Standard.



(1) Zvočna obremenitev pri 3m v prostem polju, preboj, pri 40% hitrosti, samo za primerjalne namene

## AERAILIQA

	QR340A			QR400A			QR550A		
	A	A	B	A	A	B	A	A	B
c1) Razred SEC toplo podnebje	-15,8	-12,0	-8,5	-17,3	-14,4	-11,8	-15,0	-10,7	-6,7
c2) Razred SEC zmerno podnebje	-40,3	-35,8	-31,4	-42,1	-38,7	-35,7	-39,4	-34,4	-30,0
c3) Razred SEC hladno podnebje	-83,2	-77,5	-66,8	-80,8	-76,6	-72,9	-77,4	-71,3	-66,1
Energijska nalepka	Da			Da			Da		
d) Tip naprave	Stanovanjska - dvosmerna			Stanovanjska - dvosmerna			Stanovanjska - dvosmerna		
e) Vrsta pogona	Večstopenski pogon			Večstopenski pogon			Večstopenski pogon		
f) Vrsta sistema za rekuperacijo toplote	Rekuperacija			Rekuperacija			Rekuperacija		
g) Toplotni izkoristek za rekuperacijo toplote	80			86			82		
h) Največja stopnja pretoka pri 100Pa	300			363			520		
i) Vhodna el. moč pogona ventilatorja pri max. pretoku	170			160			333		
j) Nivo zvokovne moči	53			52			58		
k) Referenčna stopnja pretoka	210			254			364		
l) Referenčna tlačna razlika	50			50			50		
m) Specifična vhodna moč	0,343			0,268			0,412		
n1) Regulacijski faktor	0,65	0,85	1,0	0,65	0,85	1,0	0,65	0,85	1,0
n2) Vrsta regulacije	Lokalni nadzor	Centralni nadzor	Ročni nadzor (ni DCV)	Lokalni nadzor	Centralni nadzor	Ročni nadzor (ni DCV)	Lokalni nadzor	Centralni nadzor	Ročni nadzor (ni DCV)
o1) Deklarirana najvišja stopnja notranjega puščanja	2,5			0,6			0,8		
o2) Deklarirana najvišja stopnja zunanega puščanja	1			0,4			0,5		
p1) Notranja hitrost mešanja	N/A			N/A			N/A		
p2) Zunanja hitrost mešanja	N/A			N/A			N/A		
q) Položaj in opis vidnega opozorila za filter	vidno opozorilo			vidno opozorilo			vidno opozorilo		
r) Navodila za namestitvev regulirne rešetke	N/A			N/A			N/A		
s) Internetni naslov z navodili za montažo									
t) Občutljivost pretoka zraka na spremembe tlaka	N/A			N/A			N/A		
u) Notranja / zunanja zračna tesnost	N/A			N/A			N/A		
v1) Letna poraba električne energije - toplo podnebje AEC	1,8	3,1	4,3	1,4	2,4	3,4	2,2	3,7	5,2
v2) Letna poraba električne energije - povprečno podnebje AEC	1,8	3,1	4,7	1,9	2,9	3,8	2,6	4,2	5,6
v3) Letna poraba električne energije - hladno podnebje AEC	1,8	3,1	10,1	7,2	8,3	9,2	8,0	9,6	11,0
w1) Prihranjeno letno ogrevanje - toplo podnebje AEC	20,3	19,7	19,3	20,8	20,4	20,1	20,5	20	19,6
w2) Prihranjeno letno ogrevanje - povprečna klima AEC	44,9	43,6	42,6	46,1	45,2	44,5	45,3	44,2	43,4
w3) Prihranjeno letno ogrevanje - hladno podnebje AEC	87,8	85,3	83,4	90,2	88,5	87,1	88,7	86,5	84,8
Glasnost pri 3m (1) pri različni hitrosti	22			21			34		
Temperatura prostora max.	+40			+40			+40		
Stopnja zaščite IP	X4			X4			X4		



## TEHNIČNI OPIS

### QR340A

Teža 23,5kg

### QR400A

Teža 34,5kg

### QR550A

Teža 44kg

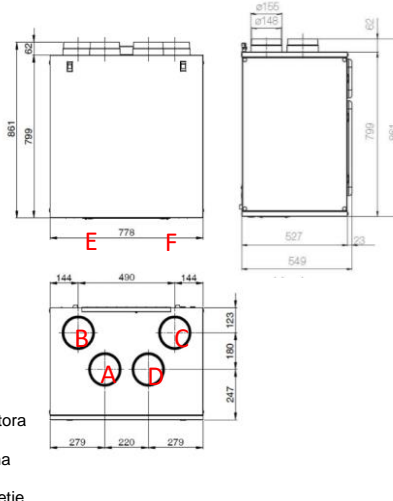
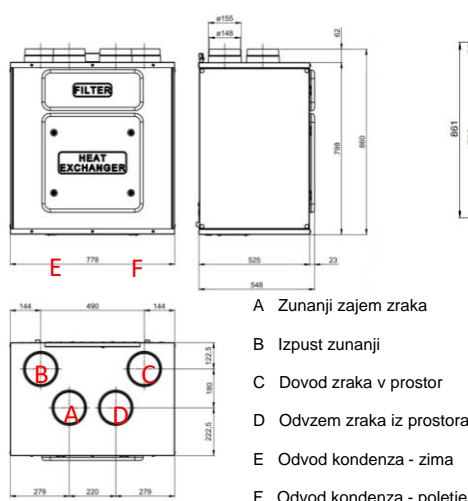
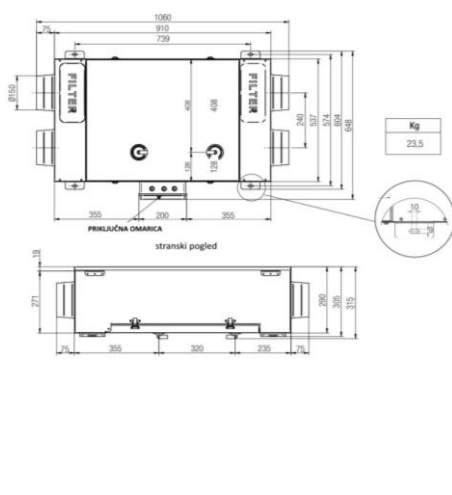

- A Zunanji zajem zraka
- B Izpust zunanji
- C Dovod zraka v prostor
- D Odvzem zraka iz prostora
- E Odvod kondenza - zima
- F Odvod kondenza - poletje

## CENTRALNA REKUPERACIJA

## REKUPERACIJSKE NAPRAVE Z ENTALPIJSKIMI IZMENJEVALCI



Koda	EAN	Naziv	Cena
001411	8058647114477	<b>QR230E</b> centralna prezračevalna naprava 202m <sup>3</sup> /h z avtomatskim bypasom in entalpijskim izmenjevalcem	<b>2.266,76</b>
004341	8058647114446	<b>QR280E</b> centralna prezračevalna naprava 256m <sup>3</sup> /h z avtomatskim bypasom in entalpijskim izmenjevalcem	<b>2.699,86</b>
001413	8058647114491	<b>QR590E</b> centralna prezračevalna naprava 561m <sup>3</sup> /h z avtomatskim bypasom in entalpijskim izmenjevalcem	<b>3.640,48</b>

Centralne prezračevalne naprave z entalpijskim izmenjevalcem so namenjene za neprekinjen odvzem toplote vlažnega zraka, odvzetega iz vlažnih prostorov, in dogrevanje svežega zraka, ki je speljan v bivalne prostore. Enostaven sistem za vsak prostor zagotavlja pravilno prezračevanje - hitro črpanje povečane ravni vlage ali onesnaževal. Predhodno ogrevanje / ohlajanje svežega zraka zmanjša potrebo po dodatnem ogrevanju oz. klimatizaciji. EC krtačni motorji bistveno zmanjšajo porabo električne energije. Pravilno vzdrževani filtri preprečujejo vstop cvetnega prahu v prostor.

Toplotni izmenjevalec omogoča visoko entalpijo toplote (85%) in vlage (65%). Zmanjšuje padce tlaka. Protimikrobna polimerna membrana, odporna na bakterije, zaustavlja razvoj plesni in kontaminacijo zraka, ter blokira vonjave. Čiščenje je enostavno.

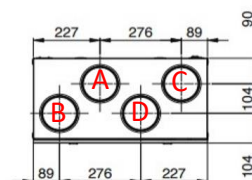
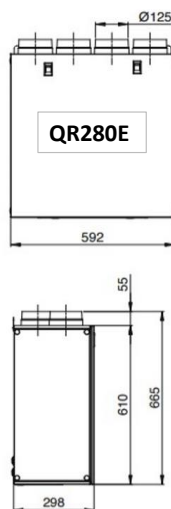
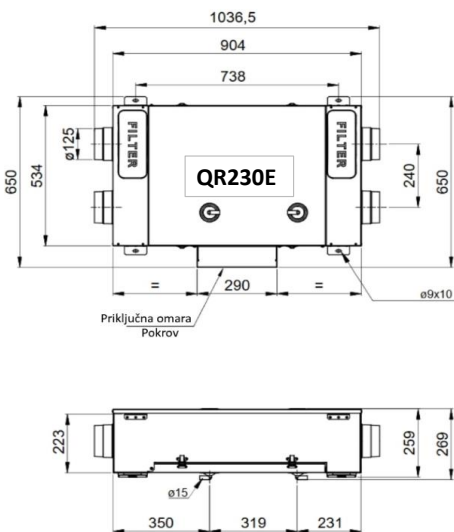

- A Zunanji zajem zraka
- B Izpust zunanji
- C Dovod zraka v prostor
- D Odvzem zraka iz prostora

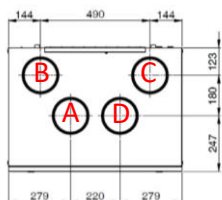
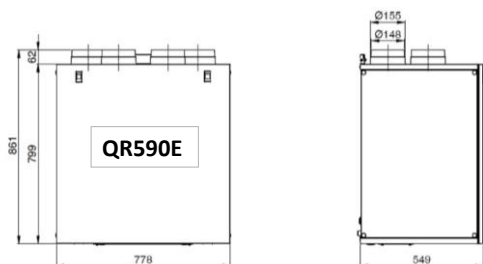

### KONTROLNA PLOŠČA CTRL-DSP

Kontrolna plošča z LCD zaslonom za samodejni nadzor omogoča 3 nastavitve hitrosti, Boost-povečanje hitrosti, počitniški način, nočni način, tedensko nastavitvev, bypass nastavitvev, nastavitvev pretoka zraka, opozorilnik zamenjave filtra in okvare ventilatorja, merilnik časa delovanja, nastavitvev varčevanja in nalaganja, primerno za daljinske senzorje (SEN-HY, SEN-PIR, SEN-CO2), vmesnik Mod-bus, povezavo na daljinsko ogrevanje, možnost prilagajanja vremenskim spremembam.

# Podatkovni list : Evropska direktiva – ErP, Uredbe 1253/2014-1254/2014

## REKUPERACIJSKE NAPRAVE Z ENTALPIJSKIMI IZMENJEVALCI

		AERAULIQA								
		QR230E			QR280E			QR590E		
		A	B	B	A	B	B	A	B	B
a) Blagovna znamka										
b) Oznaka modela										
c) Razred SEC										
c1) Razred SEC toplo podnebje	kWh/m <sup>2</sup>	-14,6	-10,4	-6,6	-14,3	-9,8	-5,8	-14,9	-10,8	-7,2
c2) Razred SEC zmerno podnebje	kWh/m <sup>2</sup>	-37,6	-32,3	-27,8	-37,2	-31,7	-26,9	-38,0	-32,9	-28,6
c3) Razred SEC hladno podnebje	kWh/m <sup>2</sup>	-73,1	-66,0	-60,1	-72,8	-65,4	-59,3	-73,7	-66,9	-61,2
Energijska nalepka		Da			Da			Da		
d) Tip naprave		Stanovanjska - dvosmerna			Stanovanjska - dvosmerna			Stanovanjska - dvosmerna		
e) Vrsta pogona		Večstopenjski pogon			Večstopenjski pogon			Večstopenjski pogon		
f) Vrsta sistema za rekuperacijo toplote		Rekuperacija			Rekuperacija			Rekuperacija		
g) Toplotni izkoristek za rekuperacijo toplote	%	70			70			71		
h) Največja stopnja pretoka pri 100Pa	m <sup>3</sup> /h	202			256			561		
i) Vhodna el. moč pogona ventilatorja pri max. pretoku	W	114			160			343		
j) Nivo zvokovne moči	dBA	50			56			58		
k) Referenčna stopnja pretoka	m <sup>3</sup> /h	142			179			393		
l) Referenčna tlačna razlika	Pa	50			50			50		
m) Specifična vhodna moč	W/m <sup>3</sup> /h	0,359			0,385			0,344		
n1) Regulaijski faktor		0,65	0,85	1,0	0,65	0,85	1,0	0,65	0,85	1,0
n2) Vrsta regulacije		Lokalni nadzor	Centralni nadzor	Ročni nadzor (ni DCV)	Lokalni nadzor	Centralni nadzor	Ročni nadzor (ni DCV)	Lokalni nadzor	Centralni nadzor	Ročni nadzor (ni DCV)
o1) Deklarirana najvišja stopnja notranjega puščanja	%	2,5			1,5			0,8		
o2) Deklarirana najvišja stopnja zunanjega puščanja	%	1			1,5			0,5		
p1) Notranja hitrost mešanja	%	N / A			N / A			N / A		
p2) Zunanja hitrost mešanja	%	N / A			N / A			N / A		
q) Položaj in opis vidnega opozorila za filter										
r) Navodila za namestitev regulirne rešetke		N / A			N / A			N / A		
s) Internetni naslov z navodili za montažo										
t) Občutljivost pretoka zraka na spremembe tlaka	%	N / A			N / A			N / A		
u) Notranja / zunanja zračna tesnost	m <sup>3</sup> /h	N / A			N / A			N / A		
v1) Letna poraba električne energije - toplo podnebje AEC	kWh	1,9	3,3	4,5	2	3,5	4,8	1,8	3,1	4,3
v2) Letna poraba električne energije - povprečno podnebje AEC	kWh	2,4	3,7	4,9	2,5	3,9	5,3	2,3	3,6	4,8
v3) Letna poraba električne energije - hladno podnebje AEC	kWh	7,7	9,1	10,3	7,9	9,3	10,7	7,6	8,9	10,1
w1) Prihranjeno letno ogrevanje - toplo podnebje AEC	kWh	19,4	18,5	17,8	19,4	18,5	17,8	19,4	18,6	18
w2) Prihranjeno letno ogrevanje - povprečna klima AEC	kWh	42,8	40,9	39,4	42,8	40,9	39,4	43	41,2	39,8
w3) Prihranjeno letno ogrevanje - hladno podnebje AEC	kWh	83,7	80	77,2	83,7	80	77,2	84,1	80,5	77,8
Glasnost pri 3m (1) pri različni hitrosti	dB (A)	21			21			21		
Temperatura prostora max.	°C	+40			+40			+40		
Stopnja zaščite IP		X4			X4			X4		



Označevanje / Oznaka  
220-240V ~ 50Hz

Zmogljivost zraka, izmerjena po ISO 5801 a 230V 50Hz, gostota zraka 1,2 kg/m<sup>3</sup>.



Type Approved  
Seguridad  
Regular Production  
Surveillance  
www.tuv.com  
ID 0217007721

Podatki so izmerjeni v priznanem laboratoriju TÜV Rheinland v Aerauliqi glede na Tehnični list IEC OD 2048 (level CTF1) za IEC 60335-1 in IEC 60335-2-80 Standard.

(1) Zvočna obremenitev pri 3m v prostem polju, preboj, pri 40% hitrosti, samo za primerjalne namene

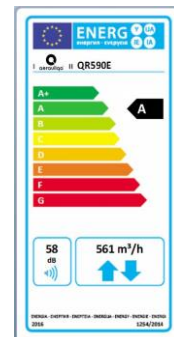
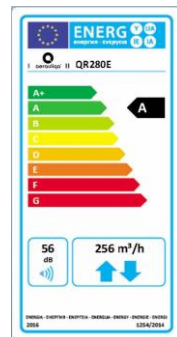
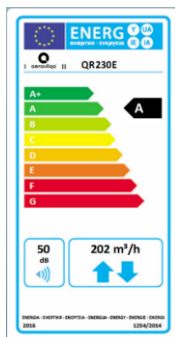

## RAZDELILNE KOMORE



Koda	<b>000575</b>	<b>003750</b>	<b>000002</b>	<b>000003</b>	<b>000004</b>
EAN					
Naziv	Razdelilna komora DN150mm 2 x DN125	Razdelilna komora DN125mm 4 x DN75	Razdelilna komora DN125mm 6 x DN75	Razdelilna komora DN160mm 10 x DN75	Razdelilna komora DN160mm 15 x DN75
Cena	<b>86,99</b>	<b>101,14</b>	<b>165,31</b>	<b>176,66</b>	<b>205,20</b>

## PREZRAČEVALNE KOMORE

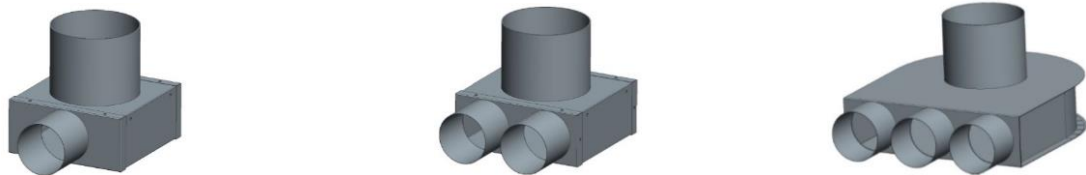

Koda	<b>AERKOM1/75</b>	<b>AERKOM2/75</b>	<b>AERKOM 3/75</b>
EAN			
Naziv	Prezračevalna komora 90° Ø75 mm za PV 125	Prezračevalna komora 90° 2x Ø75 mm za PV 125	Prezračevalna komora 90° 3x Ø75 mm za PV 125
Cena	<b>32,94</b>	<b>35,38</b>	<b>37,58</b>

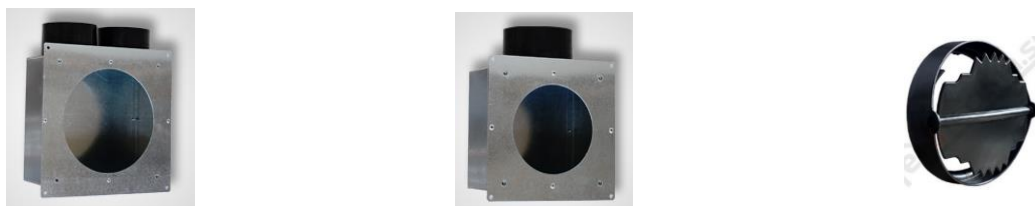

Koda	<b>000767</b>	<b>000748</b>	<b>005168</b>
EAN			
Naziv	Prezračevalna komora PLML stenska, 2x Ø75, komora 200 x 200mm	Prezračevalna komora PLML stenska, 1x Ø75mm, komora 140x140mm	Regulator / dušilec zvoka za stensko komoro PLML in PLMP Ø80 TUNE80 SILENT (3 kosi)
Cena	<b>39,89</b>	<b>32,82</b>	<b>7,08</b>



Koda	<b>000594</b>	<b>001079</b>	<b>2552VFE70</b>
EAN			4010184025528
Naziv	BCRG100 eleganten pokrov, Ø100, za komoro 000748, 000767	BCRG125 eleganten pokrov, Ø125, za komoro 000748, 000767	Zajemna komora VFE 70 s filtrom za kuhinje
Cena	<b>17,08</b>	<b>19,89</b>	<b>97,83</b>

## PREZRAČEVALNE KOMORE

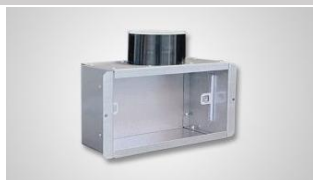

Koda	<b>005226</b>
Naziv	Prezračevalna komora PLMLS stenska, 1 x ø75 na 200 x 100mm, priključek s strani
Cena	<b>36,97</b>



Koda	<b>005227</b>
Naziv	Prezračevalna komora PLMLS stenska, 2 x ø75 na 300 x 100mm, priključka s strani
Cena	<b>45,63</b>



Koda	<b>005258</b>
Naziv	Prezračevalna komora PLMLS stenska, 3 x ø75 na 300 x 100mm, priključki s strani
Cena	<b>55,63</b>

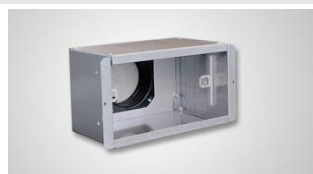

Koda	<b>005228</b>
Naziv	Prezračevalna komora PLMPS stenska, 1 x ø75 na 200 x 100mm, priključek zadaj
Cena	<b>38,43</b>



Koda	<b>005229</b>
Naziv	Prezračevalna komora PLMPS stenska, 2 x ø75 na 300 x 100mm, priključka zadaj
Cena	<b>45,63</b>



Koda	<b>005259</b>
Naziv	Prezračevalna komora PLMPS stenska, 3 x ø75 na 300 x 100mm, priključki zadaj
Cena	<b>49,53</b>



Koda	<b>005260</b>
Naziv	Prezračevalna komora PLMLCS stenska, 1 x ø75 na 200 x 100mm, priključek s strani
Cena	<b>39,89</b>



Koda	<b>003730</b>
Naziv	Rešetka GRLFQ bela 200x100mm za stensko prezračevalno komoro z magneti
Cena	<b>41,36</b>



Koda	<b>003731</b>
Naziv	Rešetka GRLFQ bela 300x100mm za stensko prezračevalno komoro z magneti
Cena	<b>41,36</b>

Koda	<b>000779</b>
Naziv	Rešetka GRLFOR bela 300x100mm za stensko prezračevalno komoro
Cena	<b>15,62</b>

Koda	<b>003729</b>
Naziv	Rešetka GRLFT bela 300x100mm za stensko prezračevalno komoro z magneti
Cena	<b>41,36</b>

## FILTRI ZA REKUPERACIJSKE ENOTE - rezervni deli



Koda	Naziv	Cena
<b>005253</b>	Filter G4-KF120G4 za QR180 / QR230	<b>39,89</b>
<b>003699</b>	Filter G4-KF180G4 za QR180 / QR230	<b>35,62</b>
<b>001676</b>	Filter G4-KF280G4 za QR280 / QR350	<b>35,62</b>
<b>005561</b>	Filter G4-KF340G4 za QR340	<b>35,62</b>
<b>003697</b>	Filter G4-KF400G4 za QR400 / QR550 / QR590	<b>36,59</b>
<b>005255</b>	Filter F7-KF120F7 za QR180 / QR230	<b>55,63</b>
<b>001809</b>	Filter F7-KF280F7 za QR280 / QR350	<b>59,78</b>
<b>005562</b>	Filter F7-KF340F7 za QR340	<b>59,78</b>
<b>003698</b>	Filter F7-KF400F7 za QR400 / QR550 / QR590	<b>51,24</b>

## FILTRI ZA LOKALNE REKUPERATORJE



Koda	Naziv	Cena
<b>004636</b>	KFNext100 4 x filter ø100 za lokalni rekuperator Quantum HR in BCRG	<b>8,54</b>
<b>003918</b>	KFNext100 4 x filter ø150 za lokalni rekuperator Quantum HR in BCRG	<b>8,54</b>
<b>001080</b>	KF100HR 3 x filter ø100 za lokalni rekuperator Quantum HR in BCRG	<b>5,61</b>
<b>001081</b>	KF150HR 3 x filter ø150 za lokalni rekuperator Quantum HR in BCRG	<b>7,08</b>



## CEVI ZA PREZRAČEVALNE SISTEME

Koda	EAN	Naziv	DN	Cena
<b>AECEV75</b>	3840207550307	Prezračevalna cev 1m	75	<b>3,27</b>
		Antistatična, antibakterijska	50m v kolutu	<b>163,48</b>
<b>001538</b>	8011963763675	Koleno 90° za cev DN75		<b>20,37</b>
<b>9395</b>		Cevna objemka IP-S 125	125	<b>9,86</b>
<b>9392</b>		Cevna objemka IP-S 160	160	<b>9,86</b>
<b>AESPOJKA75</b>		Spojka za cev	75	<b>2,31</b>
<b>AETES75</b>		Tesnilo za cev	75	<b>2,31</b>
<b>AECEP75</b>		Čep za cev	75	<b>1,34</b>



## IZOLIRANI ZRAČNI KANALI

Koda	EAN	Naziv	DN	Cena
<b>9406</b>	4010184094067	Izolirana cev IP 125/2000 mm		<b>56,93</b>
<b>9447</b>	4010184094470	Izolirana cev IP 160/2000 mm		<b>69,75</b>
<b>9399</b>	4010184093992	Izolirano koleno IP-B 125/45°		<b>12,81</b>
<b>9449</b>	4010184094494	Izolirano koleno IP-B 160/45°		<b>12,81</b>
<b>9398</b>	4010184093985	Izolirano koleno IP-B 125/90°		<b>24,40</b>
<b>9451</b>	4010184094517	Izolirano koleno IP-B 160/90°		<b>24,16</b>
<b>9394</b>	4010184093947	Spojni kos za izolirano cev IP-MU125		<b>8,63</b>
<b>9453</b>	4010184094531	Spojni kos za izolirano cev IP-IV160		<b>8,63</b>
<b>8311SVE</b>	4010184083115	Dušilec zvoka in regulator pretoka SVE 125		<b>13,55</b>
<b>8312SVE</b>	4010184083122	Dušilec zvoka in regulator pretoka SVE 160		<b>17,25</b>
<b>DUS125</b>		Dušilec zvoka gibljivi	125/180	<b>79,30</b>
<b>DUS160</b>		Dušilec zvoka gibljivi	160/200	<b>91,50</b>
<b>DUS200</b>		Dušilec zvoka gibljivi	200/200	<b>128,10</b>



## ZUNANJE REŠETKE

Koda	EAN	Naziv	DN	Cena
<b>000513</b>		Zunanja rešetka z stensko cevjo KIT DN125		<b>76,86</b>
<b>000538</b>		Zunanja rešetka z stensko cevjo KIT DN150		<b>82,96</b>

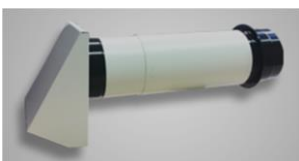

Koda	EAN	Naziv	DN	Cena
<b>000631</b>		Zunanja rešetka inox	125	<b>32,94</b>
<b>000632</b>		Zunanja rešetka inox	150	<b>34,16</b>
<b>ND12FV</b>	4750492011348	Zunanja rešetka PVC 190 x 190mm bela	125	<b>5,89</b>
<b>ND15FV</b>	4750492011386	Zunanja rešetka PVC 190 x 190mm bela	150	<b>5,89</b>



Koda	EAN	Naziv	Cena
<b>DM125</b>	4750492000595	Odvodni kovinski kanalski zračni ventil Ø125mm	<b>7,96</b>
<b>DMP125</b>	4750492000656	Dovodni kovinski kanalski zračni ventil Ø125mm	<b>7,96</b>
<b>VD125</b>	4750492000120	PV kanalski ventil Ø125mm	<b>7,35</b>
<b>VDA125</b>	4750492000182	PV kanalski ventil z vzmetjo Ø125mm	<b>7,55</b>
<b>DMKP125</b>	4750492013281	Kovinski zračni ventil Ø125mm	<b>15,66</b>



## PREZRAČEVALNI DIFUZORJI BREZ OKVIRJA

Koda	Naziv	Cena
<b>ERGO-RONDO125</b>	Zračni ventil RONDO125, univerzalni ø125mm	<b>92,72</b>
<b>ERGO-KVADRO125</b>	Zračni ventil KVADRO125, univerzalni ø125mm	<b>101,26</b>

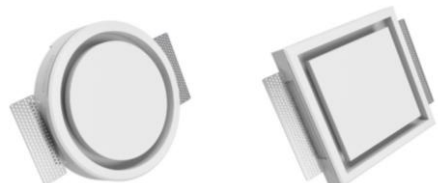

\*Po naročilu

## PVC REKUPERACIJSKI SISTEM OVA - komore, priključki, cevi



**NOVO!**

Koda	Naziv	Cena
<b>OVA-AST2X75_300</b>	OVA Stropna komora z dvema priključkoma $\varnothing 75 / 125 - 300\text{mm}$	<b>25,93</b>

<b>OVA-LSR125</b>	OVA Dušilec zvoka in regulator pretoka $\varnothing 125\text{mm}$	<b>13,42</b>
-------------------	---	--------------

Koda	Naziv	Cena
<b>OVA-MODUL160</b>	OVA Modulair razdelilna komora s priključkom $\varnothing 160\text{mm}$	<b>51,85</b>

Set vsebuje zgornjo in spodnjo stranico in vijake.

Koda	Naziv	Cena
<b>OVA-MODULFULL</b>	OVA Modulair dodatna razdelilna komora - razširitev	<b>51,85</b>

Set vsebuje 2x polno stranico in vijake.



Največje število priključkov na sestavljeni komori je 12.



Možnost združevanja razdelilnih komor v večje module.



Koda	Naziv	Cena
<b>OVA-MODUL-PRIK.</b>	OVA Modulair stranica s priključki 3 x $\varnothing 75\text{mm}$	<b>10,98</b>



Koda	Naziv	Cena
<b>OVA-MODUL-PLATA</b>	OVA Modulair polna stranica komore	<b>4,64</b>



Koda	Naziv	Cena
<b>OVA-ZAT75</b>	OVA Zatič za cev $\varnothing 75\text{mm}$ (rezervni del)	



Koda	Naziv	Premer	Cena/m
<b>OVA-CEV75PREMIUM</b>	OVA Gibljiva cev Silver Premium 75S	$\varnothing 75\text{mm}$ bela	<b>3,27</b>

Antistatična, antibakterijska



Koda	Naziv	Premer	Cena/m
<b>OVA-CEV75S *</b>	OVA Gibljiva cev Silver Standard 30S	$\varnothing 75\text{mm}$ siva	<b>2,32</b>

Antistatična



Koda	Naziv	Cena
<b>OVA-WN75</b>	OVA Tesnilo za cev $\varnothing 75\text{mm}$ (oranžno)	<b>1,37</b>

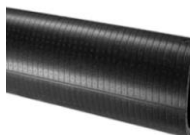

Koda	Naziv	Premer	Cena/m
<b>OVA-PIPE160</b>	OVA Cev izolirana EPP $\varnothing 160-1500\text{mm}$	$\varnothing 160\text{mm}$ črna	<b>53,68</b>

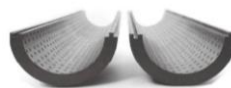

Debelina izolacije 25mm.



Koda	Naziv	Premer	Cena
<b>OVA-LOK160</b>	OVA Koleno izolirano EPP $\varnothing 160 - 90^\circ$	$\varnothing 160\text{mm}$ črna	<b>26,84</b>

Debelina izolacije 25mm.



Koda	Naziv	Cena
<b>OVA-MUFA160</b>	OVA Spojni kos PP $\varnothing 160\text{mm}$	<b>9,76</b>

<b>OVA-OPASKA160</b>	OVA Cevna objemka $\varnothing 160\text{mm}$	<b>1,10</b>
----------------------	--	-------------

## REKUPERACIJA - PREZRAČEVALNE KOMORE

Koda	Naziv	Cena
<b>AWE_VPB125-2</b>	<b>AWENTA PRO VPB125-2, prezračevalna komora 2 x DN75, stropna</b>	<b>20,62</b>

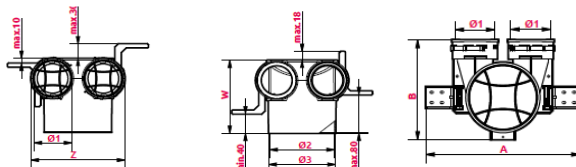

Dimenzije (mm)

ø1	ø2	ø3	A	B	Z	W
75	128	134	277	189	186	152

Koda	Naziv	Cena
<b>AWE_VPB125-3</b>	<b>AWENTA PRO VPB125-3, prezračevalna komora 3 x DN75, stropna</b>	<b>23,55</b>

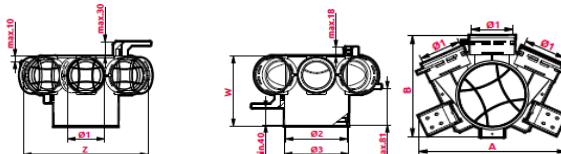

Dimenzije (mm)

ø1	ø2	ø3	A	B	Z	W
75	128	134	268	195	257	152

Koda	Naziv	Cena
<b>AWE_VPE125-2</b>	<b>AWENTA PRO VPE125-2, prezračevalna komora 2 x DN75, stenska</b>	<b>12,69</b>

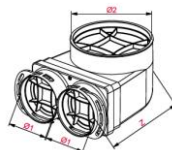

Dimenzije (mm)

ø1	ø2	Z
75	128	202

Koda	Naziv	Cena
<b>AWE_VPC125-2</b>	<b>AWENTA PRO VPC125-2, prezračevalna komora 2 x DN75, stenska</b>	<b>12,20</b>

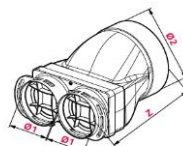

Dimenzije (mm)

ø1	ø2	Z
75	128	194

Koda	Naziv	Cena
<b>AWE_VCB160-6</b>	<b>AWENTA PRO VCB160-6, razdelilna komora 6 x DN75, ø160mm</b>	<b>77,59</b>

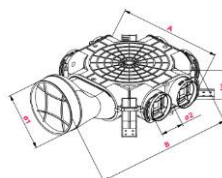

Dimenzije (mm)

ø1	ø2	A	B	W
160	75	347	475	104

Koda	Naziv	Cena
<b>AWE_VCB160-10</b>	<b>AWENTA PRO VCB160-10, razdelilna komora 10 x DN75, ø160mm</b>	<b>146,38</b>

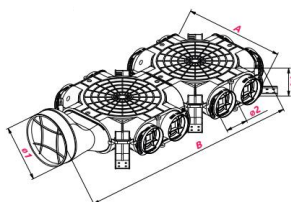

Dimenzije (mm)

ø1	ø2	A	B	W
160	75	347	766	104

Koda	Naziv	Cena
<b>AWE_VCB160-14</b>	<b>AWENTA PRO VCB160-14, razdelilna komora 14 x DN75, ø160mm</b>	<b>199,23</b>

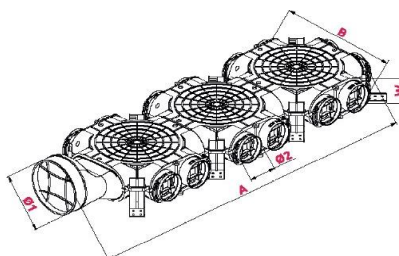

Dimenzije (mm)

ø1	ø2	A	B	W
160	75	347	1057	104



**REKUPERACIJA - PREZRAČEVALNE KOMORE**

Koda	Naziv	Cena
<b>AWE_VMK75-2-L</b>	<b>AWENTA PRO VMK75-2-L dolgi cevni prehod 2 x DN77</b>	<b>73,08</b>

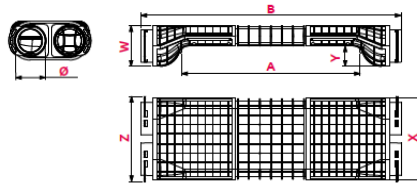

Dimenzije (mm)

Ø	W	A	B	Z	X
75	100	437	637	210	200

**REKUPERACIJA - CEVNI VENTILATOR**

Koda	Naziv	Cena
<b>AWE_VTR100DT</b>	<b>AWENTA VTR100DT cevni ventilator, časovnik</b>	<b>76,23</b>

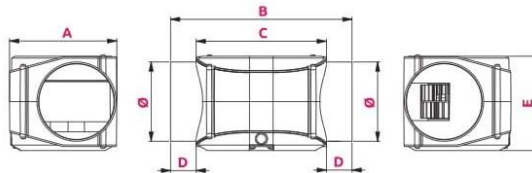

Dimenzije (mm)

Ø	A	B	C	D	E
100	136	230	165	32	119,5

**REKUPERACIJA - VENTILI**

Koda	Naziv	Cena
<b>AWE_VAK125</b>	<b>AWENTA PRO VAK125 prezračevalni ventil dovodni/odvodni Ø125mm</b>	<b>25,13</b>

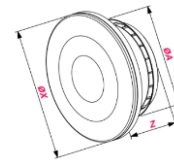

Dimenzije (mm)

ØA	Øx	Z
125	173	54

Koda	Naziv	Cena
<b>AWE_VAPO125</b>	<b>AWENTA PRO VAPO125 prezračevalni ventil dovodni/odvodni Ø125mm</b>	<b>18,91</b>

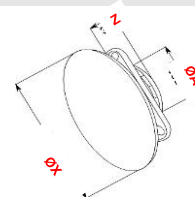

Dimenzije (mm)

ØA	Øx	Z
125	173	54

Koda	Naziv	Cena
<b>AWE_VAN75</b>	<b>AWENTA PRO VAN75 prezračevalni ventil dovodni Ø75mm</b>	<b>8,54</b>

Koda	Naziv	Cena
<b>AWE_VAW75</b>	<b>AWENTA PRO VAW75 prezračevalni ventil odvodni Ø75mm</b>	

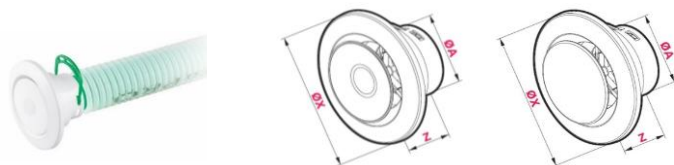

Dimenzije (mm)

ØA	Øx	Z
75	155	65

Koda	Naziv	Cena
<b>AWE_VU75-5</b>	<b>AWENTA PRO VU75-5 tesnilo za cev Ø75mm</b>	<b>0,98</b>



Koda	Naziv	Cena
<b>AWE_VNK75G</b>	<b>AWENTA PRO VNK75G rezilo za rekuperacijske cevi Ø75mm</b>	<b>3,78</b>



\*Po naročilu

\*Odprodaja



## AKSIALNI VENTILATOR iCON 15 Basic

Koda	EAN	Napetost (V)	Moč (W)	Pretok zraka (m³/h)	Glasnost (dB)	Priključna cev (Ø/m)	Teža (kg)	Cena
<b>iCON15</b>	5019009303468	230V	7,5	68	30,3	100/4	0,74	<b>145,18</b>
Funkcijski moduli PCM, TM, HTM, PRTM, PRHTM. IPX4.								
<b>iCON15S12V</b>	5019009303666	12V	7,5	68	30,3	100/4	0,74	<b>591,70</b>

Funkcijski moduli PCS, PCTS, DTS, PRTS, IPX4.  
Z ohišjem. Za vlažne prostore.  
Priložen 12V DC transformator dim.115 x 50 x 33mm.  
ECO-nizka poraba, tiho delovanje, samozapiralna krilca zmanjšujejo izgube toplote, vdor zunanega hladnega zraka in zvoka.



## AKSIALNI / CENTRIFUGALNI VENTILATOR iCON 30 Basic

Koda	EAN	Napetost (V)	Moč (W)	Pretok zraka (m³/h)	Glasnost (dB)	Priključna cev (Ø/m)	Teža (kg)	Cena
<b>iCON30 *</b>	5019009303601	230V	13	118	33,6	100/9	1,11	<b>280,60</b>
Funkcijski moduli PCM, TM, HTM, PRTM, PRHTM. IPX4.								
<b>ICON30S12V*</b>	5019009303673	12V	13	118	33,6	100/9	1,11	<b>716,14</b>

Funkcijski moduli PCS, PCTS, DTS, PRTS, IPX4.  
Z ohišjem. Za vlažne prostore.  
Priložen 12V DC transformator dim.115 x 50 x 33mm.  
ECO-nizka poraba, tiho delovanje, samozapiralna krilca zmanjšujejo izgube toplote, vdor zunanega hladnega zraka in zvoka.



## AKSIALNI / CENTRIFUGALNI VENTILATOR iCON 60 Basic

Koda	EAN	Napetost (V)	Moč (W)	Pretok zraka (m³/h)	Glasnost (dB)	Priključna cev (Ø/m)	Teža (kg)	Cena
<b>iCON60</b>	5019009303482	240V	75	260	42	150/9	1,97	<b>330,62</b>

Funkcijski moduli PCM, TM, HTM, PRTM, PRHTM. IPX4.  
Z ohišjem. Za kuhinje, večje kopalnice in bivalne prostore.

## FUNKCIJSKI MODULI za VENTILATORJE iCON Basic

Koda	EAN	Moduli za iCON 230V	Cena
<b>PCM</b>	5019009303369	Modul - potezna vrvica	<b>46,36</b>
<b>TM</b>	5019009303499	Modul - nastavljen timer 1-30min	<b>46,36</b>
<b>HTM</b>	5019009311708	Modul - senzor vlage 40 - 90%, timer, vrvica	<b>95,16</b>
<b>PRTM*</b>	5019009303390	Modul - senzor gibanja, timer	<b>192,76</b>
<b>PRHTM*</b>	5019009303376	Modul - senzor gibanja, senzor vlage, timer	<b>213,50</b>

Koda	EAN	Moduli za iCON SELV 12V DC	Cena
<b>PCS*</b>	5019009303512	Modul - potezna vrvica	<b>46,36</b>
<b>PCTS*</b>	5019009303444	Modul - nastavljen timer 1-30min	<b>81,74</b>

## DIMENZIJE VENTILATORJEV

(mm)	iCON15	iCON30	iCON60
<b>A</b>	197	225	280
<b>B</b>		141,3	165,4
<b>C</b>		29,4	46,5
<b>D</b>		97,5	147,9
<b>E</b>	52	100,9	115
<b>F</b>	92	144,3	170,3
<b>G</b>	100	147,9	176,8
<b>H</b>	40	43	55

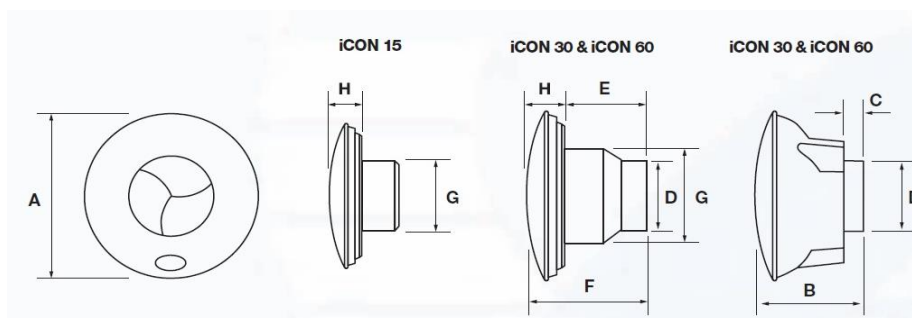

Barve pokrovov ventilatorjev po naročilu: srebrna, antracit, zlata, krom

\*Odprodaja

## CENTRIFUGALNI KOPALNIŠKI VENTILATOR QX z nepovratno loputo

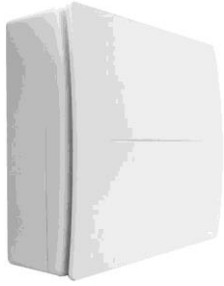

Koda	EAN	Naziv	Cena
<b>PQX00012</b>		Centrifugal QX 80T (priključ. cev Ø80, timer, 2 hitrosti, nepovr. loputa)	<b>92,60</b>
<b>PQX00013</b>	8058647111933	Centrifugal QX 80HT (priključ. cev Ø80, senzor vlage, timer, 2 hitrosti)	<b>106,87</b>
<b>PQX00014</b>	8058647111995	Centrifugal QX 100 (priključna cev Ø100, 2 hitrosti)	<b>76,98</b>
<b>PQX00015</b>	8058647112015	Centrifugal QX 100T (priključna cev Ø100 timer, 2 hitrosti)	<b>92,60</b>
<b>PQX00016</b>	8058647112039	Centrifugal QX 100HT (priključ. cev Ø100, timer, senzor vlage, 2 hitrosti)	<b>106,87</b>

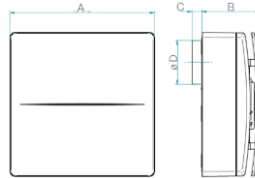

Dimenzije		
	QX80	QX100
A	241,5	241,5
B	96,5	96,5
C	17	17
ØD	73,5	96,0
Teža kg	1,8	1,8

## CENTRIFUGALNI KOPALNIŠKI VENTILATOR QXD z dodatnim cevnim izhodom in nepovratno loputo



Koda	EAN	Naziv	Cena
<b>004633</b>	8058647114262	Centrifugalni ventilator QXD100	<b>91,13</b>
<b>004646</b>	8058647114286	Centrifugalni ventilator QXD100T (timer)	<b>106,87</b>
<b>004647</b>	8058647114309	Centrifugalni ventilator QXD100HT (timer, senzor vlage)	<b>122,49</b>

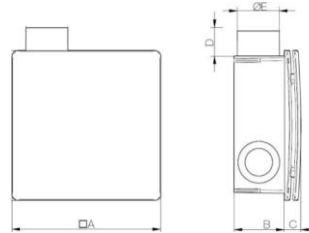

Dimenzije		
	QXD100, 100T, 100HT	
A	265	
B	119	
C	29,0	
ØD	50	
ØE	75	
Teža kg	2,25	

## AKSIALNI VENTILATOR QD100HT s časovnikom in senzorjem vlage



Koda	EAN	Naziv	Cena
<b>1792</b>		Aksialni ventilator QD100HT (timer, senzor vlage)	<b>49,90</b>

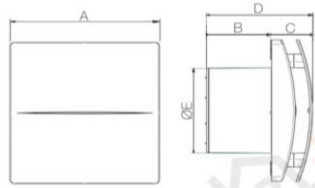

Dimenzije		
	QD100HT	
A	164	
B	70	
C	47	
D	116	
ØE	99	
Teža kg	0,6	

## ENOSMERNI AKSIALNI VENTILATOR MX za neprekinjeno delovanje s časovnikom in senzorjem vlage



Koda	EAN	Naziv	Cena
<b>004635</b>	8058647114002	Quantum MX 100HT (timer, senzor vlage)	<b>156,16</b>
<b>5857</b>		Quantum EX100HT (timer, senzor vlage)	<b>103,70</b>
<b>003686</b>		Zunanja rešetka EG150, za Quantum AX in QR100	<b>7,08</b>

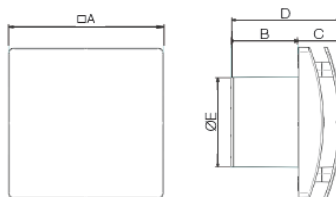

Dimenzije		
	MX100	EX100HT
A	164	164
B	46	46
C	82,0	70
D	ØD= 99	116
ØE	101,0	99
Teža kg	0,6	0,6

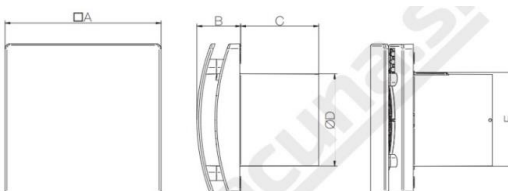

zunanja rešetka

\*Oprodaja



## STIKALA - opcija

Koda	EAN	Naziv	Cena
<b>PTM00001</b>		Stikalo s timerjem	<b>82,59</b>
<b>003688</b>	8058647113944	Stikalo s senzorjem za regulacijo vlage SEN-HY-1	<b>108,34</b>
<b>003692</b>	8058647113968	Stikalo s senzorjem prisotnosti SRL	<b>141,15</b>
<b>CCM00001*</b>		Stikalo s senzorjem CO2	<b>353,80</b>

## Podatkovni list - ErP, v skladu s predpisi Uredbe EU 1253/2014 - 1254/2014

a)		AERAULIQA							
b)		QX80T QX100 QX100T	QX80HT QX100HT	QXD100 QXD100T	QXD100HT	QD100HT	QUANTUM MX100HT	QUANTUM EX100HT	
c) Razred SEC		F	C	F	C	C	C	C	
c1)	Razred SEC toplo podnebje	kWh/m <sup>2</sup>	0,8	-7,7	1,1	-7,5	-9,6	-10,8	-11,2
c2)	Razred SEC zmerno podnebje	kWh/m <sup>2</sup>	-8,6	-23,2	-8,3	-23	-24,0	-25,2	-25,6
c3)	Razred SEC hladno podnebje	kWh/m <sup>2</sup>	-25,0	-50,2	-24,7	-50,1	-49,1	-50,3	-50,7
		Energijska nalepka	Ne	Ne	Ne	Ne	Ne	Ne	
d)	Tip naprave	Stanovanjska - dvosmerna							
e)	Vrsta pogona	Večstopenjski pogon							
f)	Vrsta sistema za rekuperacijo toplote	Ne	Ne	Ne	Ne	Ne	Ne	Ne	
g)	Toplotni izkoristek za rekuperacijo toplote	%	N/A	N/A	N/A	N/A	N/A	N/A	
h)	Največja stopnja pretoka pri 100Pa	m <sup>3</sup> /h	104	104	103	103	83	100	84
i)	Vhodna el. moč pogona ventilatorja pri max. pretoku	W	28	28	29	29	8,3	5	4,5
j)	Nivo zvokovne moči	dBA	59	59	50	50	47	43	45
k)	Referenčna stopnja pretoka	m <sup>3</sup> /h	104	104	103	103	83	72	59
l)	Referenčna tlačna razlika	Pa	10	10	10	10	10	10	20
m)	Specifična vhodna moč	W/m <sup>3</sup> /h	0,274	0,274	0,282	0,282	0,1	0,057	0,034
n1)	Regulacijski faktor		1	0,65	1	0,65	0,65	0,65	0,65
n2)	Vrsta regulacije	Lokalni nadzor							
o1)	Deklarirana najvišja stopnja notranjega puščanja	%	N/A	N/A	N/A	N/A	N/A	N/A	N/A
o2)	Deklarirana najvišja stopnja zunanega puščanja	%	N/A	N/A	N/A	N/A	N/A	2	N/A
p1)	Stopnja notranjega mešanja	%	N/A	N/A	N/A	N/A	N/A	N/A	N/A
p2)	Stopnja zunanega mešanja	%	N/A	N/A	N/A	N/A	N/A	N/A	N/A
q)	Položaj in opis vidnega opozorila za filter		N/A	N/A	N/A	N/A	N/A	N/A	N/A
r)	Navodila za namestitev regulirne rešetke	Priložena navodila							
s)	Internetni naslov z navodili za montažo	www.aerauliqa.com							
t)	Občutljivost pretoka zraka na spremembe tlaka	%	6	6	6	6	N/A	N/A	N/A
u)	Notranja / zunanja zračna tesnost	m <sup>3</sup> /h	27	27	20	20	52	52	52
v1)	Letna poraba električne energije - toplo podnebje AEC	kWh	3,4	2	3,5	2,1	0,9	0,4	0,2
v2)	Letna poraba električne energije - povprečno podnebje AEC	kWh	3,4	2	3,5	2,1	0,9	0,4	0,2
v3)	Letna poraba električne energije - hladno podnebje AEC	kWh	3,4	2	3,5	2,1	0,9	0,4	0,2
w1)	Prihranjeno letno ogrevanje - toplo podnebje AEC	kWh	7,8	12,8	7,8	12,8	11,9	11,9	11,9
w2)	Prihranjeno letno ogrevanje - povprečna klima AEC	kWh	17,2	28,3	17,2	28,3	26,2	26,2	26,2
w3)	Prihranjeno letno ogrevanje - hladno podnebje AEC	kWh	33,6	55,4	33,6	55,4	51,3	51,3	51,3
<b>Tehnične lastnosti</b>									
Pretok zraka		m <sup>3</sup> /h	62 (min.104)		103 (min.64)		103 (min.64)	90 (min.15)	102 (min.17)
Statični pritisk		Pa max.	142/251		260/164		260/164		
Poraba energije		W	17/28		29/19		29/19	5 (min.1,5)	4,5 (min.0,9)
Glasnost		dB(A)-3m	27/38		30/22		30/22	32 (min.9)	37 (min.9)
Max temp. zraka		°C	do 50°C		do 50 °C		do 50 °C	do 40°C	do 40°C
Stopnja zaščite		IP	X4 stenska vgradnja / X2 stropna vgradnja						

Označevanje / Oznaka

Zmogljivost zraka, izmerjena po ISO 5801 a 230V 50Hz, gostota zraka 1,2 kg/m<sup>3</sup>.

Podatki so izmerjeni v priznanem laboratoriju TÜV Rheinland v Aerauliqa glede na Tehnični list IEC OD 2048 (level CTF1) za IEC 60335-1 in IEC 60335-2-80 Standard.



(1) Zvočna obremenitev pri 3m v prostem polju, preboj, pri 40% hitrosti, samo za primerjalne namene.

\*Po naročilu

## AKSIALNI VENTILATORJI

## EA OKROGLI rešetka



Koda	EAN	Naziv	Moč (W)	Pretok m³/h	Cena
<b>EA100</b>	4750492006894	Aksialni ventilator EA Ø100mm	15	100	<b>20,50</b>
<b>EA125</b>	4750492006900	Aksialni ventilator EA Ø125mm	16	150	<b>22,72</b>
<b>EA150</b>	4750492007532	Aksialni ventilator EA Ø150mm	20	200	<b>28,43</b>



Koda	EAN	Naziv	Moč (W)	Pretok m³/h	Cena
<b>EA100A</b>	4750492012505	Aksialni ventilator EA Ø100mm antracit	15	100	<b>29,40</b>
<b>EA125A</b>	4750492012512	Aksialni ventilator EA Ø125mm antracit	16	150	<b>32,09</b>
<b>EA150A</b>	4750492018439	Aksialni ventilator EA Ø150mm antracit	20	200	<b>39,00</b>

## EA OKROGLI S TIMERJEM rešetka



Koda	EAN	Naziv	Moč (W)	Pretok m³/h	Cena
<b>EA100T</b>	4750492007556	Aksialni ventilator Ø100mm s timerjem	15	100	<b>36,25</b>
<b>EA125T</b>	4750492007570	Aksialni ventilator Ø125mm s timerjem	16	150	<b>39,00</b>
<b>EA150T</b>	4750492007594	Aksialni ventilator Ø150mm s timerjem	20	200	<b>45,85</b>

## EA S TIMERJEM IN SENZORJEM VLAGE rešetka



Koda	EAN	Naziv	Moč (W)	Pretok m³/h	Cena
<b>EA100HT</b>	4750492007563	Aksialni ventilator EEHT Ø100mm s timerjem in senzorjem vlage	15	100	<b>43,16</b>
<b>EA125HT</b>	4750492007587	Aksialni ventilator EEHT Ø125mm s timerjem in senzorjem vlage	16	150	<b>45,85</b>
<b>EA150HT*</b>	4750492007600	Aksialni ventilator EEHT Ø150mm s timerjem in senzorjem vlage	20	200	<b>52,73</b>

## EAT OKROGLI polni pokrov



Koda	EAN	Naziv	Moč (W)	Pretok m³/h	Cena
<b>EAT100</b>	4750492009116	Aksialni ventilator Ø100mm	15	100	<b>24,27</b>
<b>EAT125</b>	4750492009123	Aksialni ventilator Ø125mm	16	150	<b>28,43</b>
<b>EAT150</b>	4750492009130	Aksialni ventilator Ø150mm	20	200	<b>35,99</b>

## EAT OKROGLI S TIMERJEM polni pokrov



Koda	EAN	Naziv	Moč (W)	Pretok m³/h	Cena
<b>EAT100T</b>	4750492009147	Aksialni ventilator Ø100mm s timerjem	15	100	<b>37,13</b>
<b>EAT125T</b>	4750492009154	Aksialni ventilator Ø125mm s timerjem	16	150	<b>41,69</b>
<b>EAT150T</b>	4750492009161	Aksialni ventilator Ø150mm s timerjem	20	200	<b>50,01</b>

## EAT OKROGLI S TIMERJEM IN SENZORJEM VLAGE polni pokrov



Koda	EAN	Naziv	Moč (W)	Pretok m³/h	Cena
<b>EAT100HT</b>	4750492009178	Aksialni ventilator Ø100mm s timerjem in senzorjem vlage	15	100	<b>47,70</b>
<b>EAT125HT</b>	4750492009185	Aksialni ventilator Ø125mm s timerjem in senzorjem vlage	16	150	<b>52,73</b>
<b>EAT150HT</b>	4750492009192	Aksialni ventilator Ø150mm s timerjem in senzorjem vlage	20	200	<b>61,87</b>

\*Po naročilu

## AKSIALNI VENTILATORJI

## EE KVADRATNI rešetka



Koda	EAN	Naziv	Moč (W)	Pretok m³/h	Cena
<b>EE100</b>	4750492006917	Aksialni ventilator EE Ø100mm	15	100	<b>15,31</b>
<b>EE125</b>	4750492006924	Aksialni ventilator EE Ø125mm	16	150	<b>19,24</b>
<b>EE150*</b>	4750492006931	Aksialni ventilator EE Ø150mm	20	200	<b>23,60</b>



Koda	EAN	Naziv	Moč (W)	Pretok m³/h	Cena
<b>EE100A</b>	4750492012529	Aksialni ventilator EE Ø100mm, antracit	15	100	<b>21,58</b>
<b>EE125A</b>	4750492012550	Aksialni ventilator EE Ø125mm, antracit	16	150	<b>24,04</b>
<b>EE150A</b>	4750492012895	Aksialni ventilator EE Ø150mm, antracit	20	200	<b>30,74</b>



## EE KVADRATNI S TIMERJEM rešetka

Koda	EAN	Naziv	Moč (W)	Pretok m³/h	Cena
<b>EE100T</b>	4750492007198	Aksialni ventilator EET Ø100mm s timerjem	15	100	<b>28,90</b>
<b>EE125T</b>	4750492007303	Aksialni ventilator EET Ø125mm s timerjem	16	150	<b>31,30</b>
<b>EE150T</b>	4750492008898	Aksialni ventilator EET Ø150mm s timerjem	20	200	<b>45,41</b>



## EE KVADRATNI S TIMERJEM IN SENZORJEM VLAGE rešetka

Koda	EAN	Naziv	Moč (W)	Pretok m³/h	Cena
<b>EE100HT</b>	4750492007150	Aksialni ventilator EEHT Ø100mm s timerjem in senzorjem vlage	15	100	<b>36,10</b>
<b>EE125HT</b>	4750492007266	Aksialni ventilator EEHT Ø125mm s timerjem in senzorjem vlage	16	150	<b>38,53</b>
<b>EE150HT</b>	4750492007372	Aksialni ventilator EEHT Ø150mm s timerjem in senzorjem vlage	20	200	<b>43,13</b>



## EET KVADRATNI polni pokrov

Koda	EAN	Naziv	Moč (W)	Pretok m³/h	Cena
<b>EET100</b>	4750492008805	Aksialni ventilator EET Ø100mm	15	100	<b>20,61</b>
<b>EET125</b>	4750492008782	Aksialni ventilator EET Ø125mm	16	150	<b>25,27</b>
<b>EET150</b>	4750492008799	Aksialni ventilator EET Ø150mm	20	200	<b>30,86</b>



## EET KVADRATNI S TIMERJEM polni pokrov

Koda	EAN	Naziv	Moč (W)	Pretok m³/h	Cena
<b>EET100T</b>	4750492008874	Aksialni ventilator EETT Ø100mm s timerjem	15	100	<b>33,73</b>
<b>EET125T</b>	4750492008881	Aksialni ventilator EETT Ø125mm s timerjem	16	150	<b>38,53</b>
<b>EET150T</b>	4750492008898	Aksialni ventilator EETT Ø150mm s timerjem	20	200	<b>45,41</b>



## EET KVADRATNI S TIMERJEM IN SENZORJEM VLAGE polni pokrov

Koda	EAN	Naziv	Moč (W)	Pretok m³/h	Cena
<b>EET100HT</b>	4750492009048	Aksialni ventilator EETHT Ø100mm s timerjem in senzorjem vlage	15	100	<b>40,93</b>
<b>EET125HT</b>	4750492009031	Aksialni ventilator EETHT Ø125mm s timerjem in senzorjem vlage	16	150	<b>45,76</b>
<b>EET150HT</b>	4750492009024	Aksialni ventilator EETHT Ø150mm s timerjem in senzorjem vlage	20	200	<b>52,24</b>

\*Po naročilu

## KANALSKI VENTILATORJI NEPOVRATNI VENTIL PRI VENTILATORJU



Koda	EAN	Naziv	Cena
<b>EEV100</b>	4750492008591	Nepovratni ventil ventilatorja Ø100mm	<b>3,46</b>
<b>EEV125</b>	4750492008607	Nepovratni ventil ventilatorja Ø125mm	<b>4,13</b>



## PVC OKROGLI KANALSKI VENTILATOR EK

Koda	EAN	Naziv	Pretok m³/h	Cena
<b>EK100</b>	4750492006566	PVC okrogli kanalski ventilator Ø100mm	100	<b>14,49</b>
<b>EK100T</b>	4750492006573	PVC okrogli kanalski ventilator Ø100mm s timerjem	100	<b>27,93</b>
<b>EK125</b>	4750492006580	PVC okrogli kanalski ventilator Ø125mm	150	<b>16,25</b>
<b>EK125T</b>	4750492006597	PVC okrogli kanalski ventilator Ø125mm s timerjem	150	<b>29,87</b>
<b>EK150</b>	4750492006603	PVC okrogli kanalski ventilator Ø150mm	200	<b>20,58</b>
<b>EK150T</b>	4750492006610	PVC okrogli kanalski ventilator Ø150mm s timerjem	200	<b>34,70</b>



## OKROGLI KANALSKI VENTILATOR AKM

Koda	EAN	Naziv	Moč (W)	Pretok m³/h	Cena
<b>AKM100</b>	4750492217467	Okrogli kanalski ventilator Ø100m	74	379	<b>145,49</b>
<b>AKM125</b>	4750492217474	Okrogli kanalski ventilator Ø125mm	74	421	<b>147,10</b>
<b>AKM160</b>	4750492217481	Okrogli kanalski ventilator Ø160mm	103	866	<b>187,48</b>



## REGULATOR OBRATOV ZA OKROGLI KANALSKI VENTILATOR

Koda	EAN	Naziv	Cena
<b>AR1.5</b>	4750492219294	Regulator obratov za kanalski ventilator	<b>50,10</b>



## OBJEMKA ZA OKROGLI KANALSKI VENTILATOR

Koda	EAN	Naziv	Cena
<b>MSV100</b>	4750492219300	Objemka Ø100mm za okrogle kanalske ventilatorje	<b>7,14</b>
<b>MSV125</b>	4750492219317	Objemka Ø125mm za okrogle kanalske ventilatorje	<b>7,93</b>
<b>MSV160</b>	4750492219324	Objemka Ø160mm za okrogle kanalske ventilatorje	<b>8,58</b>
<b>MSV200</b>	4750492219331	Objemka Ø200mm za okrogle kanalske ventilatorje	<b>9,46</b>
<b>MSV250</b>	4750492219348	Objemka Ø250mm za okrogle kanalske ventilatorje	<b>10,60</b>
<b>MSV315</b>	4750492219355	Objemka Ø315mm za okrogle kanalske ventilatorje	<b>12,36</b>

\*Po naročilu

\*Odprodaja

## ALUMINIJASTA GIBLJIVA CEV do +250°C - 2000 Pa

Koda	EAN	Naziv	Pakiranje (kos)	Cena
<b>G80</b>	4750492000847	Aluminijasta gibljiva cev Ø80mm L-3m	54	<b>8,462</b>
<b>G100</b>	4750492000854	Aluminijasta gibljiva cev Ø100mm L-3m	72	<b>9,721</b>
<b>G120</b>	4750492001639	Aluminijasta gibljiva cev Ø120mm L-3m	55	<b>12,034</b>
<b>G125</b>	4750492000878	Aluminijasta gibljiva cev Ø125mm L-3m	55	<b>12,034</b>
<b>G150</b>	4750492000892	Aluminijasta gibljiva cev Ø150mm L-3m	35	<b>14,786</b>
<b>G160</b>	4750492000908	Aluminijasta gibljiva cev Ø160mm L-3m	30	<b>24,534</b>
<b>G200</b>	4750492000915	Aluminijasta gibljiva cev Ø200mm L-3m	19	<b>19,618</b>
<b>G250</b>	4750492000922	Aluminijasta gibljiva cev Ø250mm L-3m	12	<b>24,537</b>
<b>G315 *</b>	4750492000939	Aluminijasta gibljiva cev Ø315mm L-3m	6	<b>34,375</b>

## ALUMINIJASTA GIBLJIVA CEV BELA do +250°C - 2000 Pa

Koda	EAN	Naziv	Pakiranje (kos)	Cena
<b>G100B</b>	4750492001684	Aluminijasta gibljiva cev bela, Ø100mm L-3m	38	<b>19,149</b>
<b>G120B *</b>	4750492001707	Aluminijasta gibljiva cev bela, Ø120mm L-3m	28	<b>23,600</b>
<b>G125B</b>	4750492001721	Aluminijasta gibljiva cev bela, Ø125mm L-3m	24	<b>23,951</b>

## POLIFLEX GIBLJIVA CEV do 80°C

Koda	EAN	Naziv	Pakiranje (k)	Cena
<b>FP100</b>	4750492105429	Polyflex gibljiva cev Ø102mm L-10m	10	<b>18,241</b>
<b>FP125</b>	4750492105436	Polyflex gibljiva cev Ø127mm L-10m	12	<b>22,926</b>
<b>FP160</b>	4750492105450	Polyflex gibljiva cev Ø162mm L-10m	6	<b>28,636</b>
<b>FP200</b>	4750492105467	Polyflex gibljiva cev Ø202mm L-10m	4	<b>38,328</b>

## IZOLIRANA CEV od -30°C do +140°C

Koda	EAN	Naziv	Pakiranje (kos)	Cena
<b>FAT100</b>	4750492220351	Toplotno izolirana al. cev Ø102mm, dolž.10m	1	<b>53,846</b>
<b>FAT125</b>	4750492220368	Toplotno izolirana al. cev Ø127mm, dolž.10m	1	<b>62,425</b>
<b>FAT160</b>	4750492220382	Toplotno izolirana al. cev Ø162mm, dolž.10m	1	<b>79,612</b>
<b>FAT200</b>	4750492220399	Toplotno izolirana al. cev Ø202mm, dolž.10m	1	<b>90,241</b>
<b>FAS100</b>	4750492221105	Toplotno in zvočno izolirana al. cev Ø102mm, dolžina 10m	1	<b>53,846</b>
<b>FAS125</b>	4750492221112	Toplotno in zvočno izolirana al. cev Ø127mm, dolžina 10m	1	<b>62,425</b>
<b>FAS160</b>	4750492221136	Toplotno in zvočno izolirano al. cev Ø162mm, dolžina 10m	1	<b>79,612</b>
<b>FAS200</b>	4750492221143	Toplotno in zvočno izolirano al. cev Ø202mm, dolžina 10m	1	<b>90,241</b>

## ALUMINIJAST LEPILNI TRAK

Koda	EAN	Naziv	Pakiranje (kos)	Cena
<b>LA50-50</b>	4750492104781	Trak lepilni aluminij 50mm, dolžina 50m	24	<b>13,937</b>
<b>LA75-50</b>	4750492104774	Trak lepilni aluminij 75mm, dolžina 50m	16	<b>20,760</b>
<b>LAS50-50</b>	4750492104804	Trak lepilni aluminij z mrežico 50mm, dolž. 50m	24	<b>14,318</b>
<b>LAS75-50</b>	4750492105061	Trak lepilni aluminij z mrežico 75mm, dolž. 50m	16	<b>21,404</b>
<b>LU48-10</b>	4750492104491	Trak vodotesni lepilni 48mm, dolžina 10m	72	<b>2,811</b>
<b>LU48-25</b>	4750492104507	Trak vodotesni lepilni 48mm, dolžina 25m	36	<b>5,153</b>
<b>LU48-50</b>	4750492104514	Trak vodotesni lepilni 48mm, dolžina 50m	24	<b>9,575</b>



\*Po naročilu

\*Odprodaja

## PVC CEVI IN PRIKLJUČKI za prezračevanje - ploščati

Koda	EAN	Naziv	Pakiranje (kos)	Cena
<b>K-0.5</b>	4750492102817	PVC pravokotna cev 110mm x 55mm, dolž.0,5m	20	<b>3,953</b>
<b>K-1</b>	4750492102824	PVC pravokotna cev 110mm x 55mm, dolž.1m	10	<b>6,998</b>
<b>K-1.5</b>	4750492102831	PVC pravokotna cev 110mm x 55mm, dolž.1,5m	10	<b>10,219</b>
<b>K25-0.5</b>	4750492218716	PVC pravokotna cev 220mm x 55mm, dolž.0,5m	50	<b>7,027</b>
<b>K25-1</b>	4750492218723	PVC pravokotna cev 220mm x 55mm, dolž.1m	5	<b>13,791</b>
<b>K25-1.5</b>	4750492218730	PVC pravokotna cev 220mm x 55mm, dolž.1,5m	5	<b>20,467</b>
<b>K29-0.5</b>	4750492023914	PVC pravokotna cev 220mm x 90mm, dolž.0,5m	6	<b>9,457</b>
<b>K29-1</b>	4750492023921	PVC pravokotna cev 220mm x 90mm, dolž.1m	5	<b>18,329</b>
<b>K29-1.5</b>	4750492023938	PVC pravokotna cev 220mm x 90mm, dolž.1,5m	5	<b>27,377</b>
<b>KMS</b>	4750492017074	Fleksibilna cev kvadratna 110mm x 55mm, 0,5m	10	<b>10,365</b>
<b>KMS25</b>	4750492017081	Fleksibilna cev kvadratna 220mm x 55mm, 0,5m	10	<b>17,773</b>
<b>KMS29</b>	4750492024164	Fleksibilna cev kvadratna 220mm x 90mm, 0,5m		<b>21,404</b>
<b>KL<sup>V</sup>*</b>	4750492102909	PVC vertikalno koleno 110mm x 55mm, 90°	10	<b>2,723</b>
<b>KL<sup>V</sup>25-90</b>	4750492218655	PVC vertikalno koleno 220mm x 55mm, 90°	6	<b>4,568</b>
<b>KL<sup>V</sup>29-90</b>	4750492024157	PVC vertikalno koleno 220mm x 90mm, 90°	6	<b>6,237</b>
<b>KL<sup>H</sup>*</b>	4750492102893	PVC horizontalno koleno 110mm x 55mm, 90°	10	<b>2,957</b>
<b>KL<sup>H</sup>25-90</b>	4750492218686	PVC horizontalno koleno 220mm x 55mm, 90°	6	<b>6,998</b>
<b>KL<sup>H</sup>29-90</b>	4750492024140	PVC horizontalno koleno 220mm x 90mm, 90°	4	<b>10,336</b>
<b>KL<sup>H</sup>15-60</b>	4750492105306	PVC horizontalno koleno 110mm x 55mm, 15°- 60°	10	<b>2,987</b>
<b>KT</b>	4750492102886	PVC T-spoj 110mm x 55mm	10	<b>3,104</b>
<b>KT25</b>	4750492218709	PVC T-spoj 220mm x 55mm	6	<b>8,257</b>
<b>KT29</b>	4750492024201	PVC T-spoj 220mm x 90mm	5	<b>12,503</b>
<b>KS29-25</b>	4750492024188	PVC adapter 220mm x 90 / 50mm	10	<b>3,572</b>
<b>KS25-15</b>	4750492222621	PVC prikladni reducirni kanal 220mm x 55mm / 110mm x 55mm	15	<b>3,338</b>

\*Po naročilu

\*Odprodaja

## PVC CEVI IN PRIKLJUČKI za prežračevanje - ploščati



Koda	EAN	Naziv	Pakiranje (kos)	Cena
<b>KSF</b>	4750492007808	PVC kanalski spoj 110mm x 55mm		<b>6,998</b>
<b>KSF25</b>	4750492007815	PVC kanalski spoj 220mm x 55mm		<b>2,313</b>
<b>KSF29</b>	4750492024232	PVC kanalski spoj 220mm x 90mm	10	<b>3,045</b>



<b>KS</b>	4750492102848	PVC priklonni kanal 110mm x 55mm	10	<b>1,464</b>
<b>KS25</b>	4750492218631	PVC priklonni kanal 220mm x 55mm	10	<b>3,162</b>
<b>KS29</b>	4750492024171	PVC priklonni kanal 220mm x 90mm	10	<b>3,045</b>



<b>KFF</b>	4750492019016	PVC ploščati spoj 110mm x 55mm / 1 stran	10	<b>2,518</b>
<b>KFF25</b>	4750492024058	PVC ploščati spoj 220mm x 55mm / 1 stran	10	<b>3,782</b>
<b>KFF29</b>	4750492024065	PVC ploščati spoj 220mm x 90mm / 1 stran	10	<b>4,392</b>



<b>KFS</b>	4750492018996	PVC ploščati spoj 110mm x 55mm / 2 strani	10	<b>3,631</b>
<b>KFS25</b>	4750492024072	PVC ploščati spoj 220mm x 55mm / 2 strani	10	<b>4,746</b>
<b>KFS29</b>	4750492024089	PVC ploščati spoj 220mm x 90mm / 2 strani	10	<b>5,358</b>

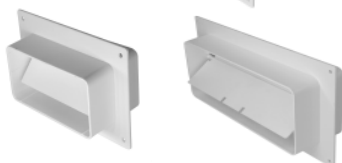

<b>KFV</b>	4750492019009	PVC ploščati spoj 2 z loputo 110mm x 55mm	10	<b>4,070</b>
<b>KFV25</b>	4750492024096	PVC ploščati spoj 2 z loputo 220mm x 55mm	10	<b>5,795</b>
<b>KFV29</b>	4750492024102	PVC ploščati spoj 2 z loputo 220mm x 90mm	10	<b>6,588</b>



<b>KV*</b>	4750492104132	PVC kanalski priključek s pokrovom 110mm x 55mm	10	<b>1,874</b>
------------	---------------	---	----	--------------

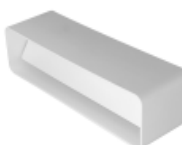

<b>KV25</b>	4750492218648	PVC kanalski priključek s pokrovom 220mm x 55mm	10	<b>3,836</b>
-------------	---------------	---	----	--------------



<b>KV29</b>	4750492024218	PVC kanalski priključek s pokrovom 220mm x 90mm	10	<b>3,806</b>
-------------	---------------	---	----	--------------



<b>KF</b>	4750492102923	PVC ploščata zidna prirobnica 110mm x 55mm, 90°	50	<b>1,376</b>
-----------	---------------	---	----	--------------

<b>KF25</b>	4750492218624	PVC ploščata zidna prirobnica 220mm x 55mm, 90°	50	<b>2,313</b>
-------------	---------------	---	----	--------------



<b>KLD</b>	4750492102916	PVC koleno kvadratno / okroglo 110mm x 55mm, 90°	15	<b>2,342</b>
------------	---------------	--	----	--------------

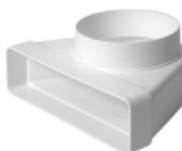

<b>KLD25-100</b>	4750492222614	PVC koleno kvadratno / okroglo 220mm x 55mm, Ø 100mm	6	<b>5,329</b>
------------------	---------------	--	---	--------------

<b>KLD25-125</b>	4750492218679	PVC koleno kvadratno / okroglo 220mm x 55mm, Ø 125mm	6	<b>5,329</b>
------------------	---------------	--	---	--------------



<b>KLD29-100</b>	4750492024119	PVC koleno kvadratno / okroglo 220mm x 90mm, Ø 100mm	6	<b>8,813</b>
------------------	---------------	--	---	--------------

<b>KLD29-125</b>	4750492024126	PVC koleno kvadratno / okroglo 220mm x 90mm, Ø 125mm	6	<b>8,813</b>
------------------	---------------	--	---	--------------

<b>KLD29-150</b>	4750492024133	PVC koleno kvadratno / okroglo 220mm x 90mm, Ø 150mm	6	<b>8,813</b>
------------------	---------------	--	---	--------------

\*Po naročilu \*Odprodaja

## PVC CEVI IN PRIKLJUČKI za prezračevanje - ploščati

Koda	EAN	Naziv	Pakiranje (kos)	Cena
<b>KSD1</b>	4750492102855	PVC adapter kratki kvadratni / okrogli 110mm x 55mm, Ø100mm	10	<b>1,669</b>
<b>KSD2</b>	4750492102862	PVC adapter dolgi kvadratni / okrogli 110mm x 55mm, Ø100mm	10	<b>2,635</b>
<b>KSD25-125</b>	4750492218662	PVC adapter dolgi kvadratni / okrogli 220mm x 55mm, Ø125mm	10	<b>4,919</b>
<b>KSD29-150</b>	4750492024195	PVC adapter dolgi kvadratni / okrogli 220mm x 90mm / Ø150mm	5	<b>7,466</b>
<b>KZ</b>	4750492102879	PVC spone dva kosa 110mm x 55mm	15	<b>1,786</b>
<b>KZ25</b>	4750492218617	PVC spone dva kosa 220mm x 55mm	15	<b>2,723</b>
<b>KZ29</b>	4750492024225	PVC spone dva kosa 220mm x 90mm	10	<b>2,137</b>

## PVC CEVI IN PRIKLJUČKI za prezračevanje - okrogli

Koda	EAN	Naziv	Pakiranje (kos)	Cena
<b>A100-0.5</b>	4750492216453	PVC okrogla cev Ø100mm, dolžina 0,5m	12	<b>3,631</b>
<b>A100-1</b>	4750492216460	PVC okrogla cev Ø100mm, dolžina 1m	6	<b>6,764</b>
<b>A100-1.5</b>	4750492216477	PVC okrogla cev Ø100mm, dolžina 1,5m	6	<b>9,955</b>
<b>A125-0.5</b>	4750492218549	PVC okrogla cev Ø125mm, dolžina 0,5m	9	<b>4,480</b>
<b>A125-1</b>	4750492218556	PVC okrogla cev Ø125mm, dolžina 1m	4	<b>9,311</b>
<b>A125-1.5</b>	4750492218563	PVC okrogla cev Ø125mm, dolžina 1,5m	4	<b>13,498</b>
<b>A150-0.5</b>	4750492023860	PVC okrogla cev Ø150mm, dolžina 0,5m	5	<b>7,174</b>
<b>A150-1</b>	4750492023877	PVC okrogla cev Ø150mm, dolžina 1m	5	<b>13,498</b>
<b>A150-1</b>	4750492023877	PVC okrogla cev Ø150mm, dolžina 1,5m	5	<b>20,028</b>
<b>A100T-0.3</b>	4750492018286	PVC okrogla cev teleskopska Ø100mm, dolž. 3-5m		<b>7,408</b>
<b>A125T-0.3</b>	4750492018293	PVC okrogla cev teleskopska Ø125mm, dolž. 3-5m		<b>10,219</b>
<b>A150T-0.3</b>	4750492023891	PVC okrogla cev teleskopska Ø150mm, dolž. 3-5m		<b>9,370</b>
<b>AMS100</b>	4750492017050	Fleksibilna cev okrogla Ø100mm, dolžina 0,5m	10	<b>9,457</b>
<b>AMS125</b>	4750492017067	Fleksibilna cev okrogla Ø125mm, dolžina 0,5m	10	<b>11,039</b>
<b>AMS150</b>	4750492023990	Fleksibilna cev okrogla Ø150mm, dolžina 0,5m	10	<b>13,732</b>
<b>AZ100</b>	4750492216484	PVC okroglo držalo Ø100mm 2 kosa	10	<b>1,903</b>
<b>AZ125</b>	4750492218587	PVC okroglo držalo Ø125mm 2 kosa	10	<b>2,723</b>
<b>AZ150</b>	4750492024041	PVC okroglo držalo Ø150mm 2 kosa	10	<b>2,430</b>

\*Po naročilu

\*Odprodaja

## PVC CEVI IN PRIKLJUČKI za prezračevanje - okrogli

Koda	EAN	Naziv	Pakiranje (kos)	Cena
<b>AS100</b>	4750492211953	PVC priklonni kanal okrogli Ø100mm	10	<b>1,698</b>
<b>AS125</b>	4750492211960	PVC priklonni kanal okrogli Ø125mm	10	<b>1,903</b>
<b>AS150</b>	4750492024010	PVC priklonni kanal okrogli Ø150mm	10	<b>2,577</b>
<b>ASF100</b>	4750492007822	PVC spojka okrogla Ø100mm	10	<b>3,045</b>
<b>ASF125</b>	4750492007839	PVC spojka okrogla Ø125mm	10	<b>3,045</b>
<b>ASF150</b>	4750492023907	PVC spojka okrogla Ø150mm	10	<b>3,045</b>
<b>AT100</b>	4750492211977	PVC T-kos Ø100mm / Ø100mm	15	<b>3,719</b>
<b>AT125</b>	4750492211984	PVC T-kos Ø125mm / Ø125mm	5	<b>6,676</b>
<b>AT150</b>	4750492024027	PVC T-kos Ø150mm / Ø150mm	4	<b>10,746</b>
<b>AL100-45</b>	4750492005224	PVC koleno Ø100mm / 45°	4	<b>6,120</b>
<b>AL125-45</b>	4750492023969	PVC koleno Ø125mm / 45°	4	<b>5,124</b>
<b>AL150-45</b>	4750492023976	PVC koleno Ø150mm / 45°	4	<b>6,120</b>
<b>AL100-90</b>	4750492216491	PVC koleno Ø100mm / 90°	15	<b>2,869</b>
<b>AL125-90</b>	4750492218570	PVC koleno Ø125mm / 90°	6	<b>5,124</b>
<b>AL150-90</b>	4750492023983	PVC koleno Ø150mm / 90°	6	<b>7,818</b>
<b>AFS100</b>	4750492211946	PVC stenski priključek Ø100mm	10	<b>2,137</b>
<b>AFS125</b>	4750492211939	PVC stenski priključek Ø125mm	10	<b>2,782</b>
<b>AFS150</b>	4750492023945	PVC stenski priključek Ø150mm	10	<b>3,279</b>
<b>AFV100</b>	4750492212004	PVC stenski priključek z loputo Ø100mm	10	<b>2,694</b>
<b>AFV125</b>	4750492211991	PVC stenski priključek z loputo Ø125mm	10	<b>3,338</b>
<b>AFV150</b>	4750492023952	PVC stenski priključek z loputo Ø150mm	10	<b>4,041</b>
<b>AV100</b>	4750492211977	PVC priklonni kanal z loputo Ø100mm	10	<b>1,991</b>
<b>AV125</b>	4750492211984	PVC priklonni kanal z loputo Ø125mm	10	<b>2,518</b>
<b>AV150</b>	4750492024034	PVC priklonni kanal z loputo Ø150mm	10	<b>3,279</b>
<b>AP125-100</b>	4750492222607	PVC prehodni kos 125/100mm	6	<b>3,162</b>
<b>AP150-125</b>	4750492024003	PVC prehodni kos 150/125mm	6	<b>3,953</b>
<b>VA80</b>	4750492102930	PVC stopenjska reducirka 80-100-120-125-150mm	10	<b>2,342</b>



\*Po naročilu

\*Odprodaja

## PVC CEVI IN PRIKLJUČKI za prezračevanje - okrogli

Koda	EAN	Naziv	Pakiranje (kos)	Cena
<b>VA90</b>	4750492000748	PVC prehod kvadratni/okrogli 90mm x 90mm / Ø100mm	12	<b>1,874</b>
<b>VA91</b>	4750492103999	PVC prehod kvadratni/okrogli 100mm x 100mm / Ø100mm	12	<b>1,874</b>
<b>VF100</b>	4750492001592	PVC podaljšek za PV ventil Ø100mm	10	<b>1,991</b>
<b>VF125</b>	4750492001608	PVC podaljšek za PV ventil Ø125mm	10	<b>1,991</b>
<b>VF150</b>	4750492001615	PVC podaljšek za PV ventil Ø150mm	10	<b>2,460</b>
<b>VA100</b>	4750492000267	PVC adapter 160mm x 250mm Ø100mm	10	<b>2,547</b>
<b>VA120</b>	4750492210437	PVC adapter 160mm x 250mm Ø120mm	10	<b>2,811</b>
<b>VA125</b>	4750492000274	PVC adapter 160mm x 250mm Ø125mm	10	<b>2,664</b>
<b>VA150</b>	4750492000441	PVC adapter 190mm x 250mm Ø150mm	10	<b>3,601</b>
<b>NA10</b>	4750492104316	PVC rešetka priključek 250mm x 180mm Ø100mm s prirobnico	10	<b>3,221</b>

## KOVINSKI ZRAČNI VENTILI

Koda	EAN	Naziv	Pakiranje (kos)	Cena
<b>DM80</b>	4750492000571	Odvodni kovinski zračni ventil Ø80mm	10	<b>5,388</b>
<b>DM100</b>	4750492000588	Odvodni kovinski zračni ventil Ø100mm	10	<b>5,915</b>
<b>DM125</b>	4750492000595	Odvodni kovinski zračni ventil Ø125mm	10	<b>7,964</b>
<b>DMP80</b>	4750492000632	Dovodni kovinski zračni ventil Ø80mm	10	<b>4,890</b>
<b>DMP100</b>	4750492000649	Dovodni kovinski zračni ventil Ø100mm	10	<b>5,915</b>
<b>DMP125</b>	4750492000656	Dovodni kovinski zračni ventil Ø125mm	10	<b>7,964</b>
<b>DMP160 *</b>	4750492000670	Dovodni kovinski zračni ventil Ø160mm	10	<b>12,210</b>
<b>DMKP100 *</b>	4750492013274	Kovinski zračni ventil Ø100mm	10	<b>11,675</b>
<b>DMKP125</b>	4750492013281	Kovinski zračni ventil Ø125mm	10	<b>15,665</b>
<b>DMKP160 *</b>	4750492013298	Kovinski zračni ventil Ø160mm	10	<b>21,472</b>

## PVC ZRAČNI VENTILI

Koda	EAN	Naziv	Pakiranje (kos)	Cena
<b>VD100</b>	4750492000113	PV ventil Ø100mm	10	<b>5,944</b>
<b>VD125</b>	4750492000120	PV ventil Ø125mm	10	<b>7,349</b>
<b>VD150</b>	4750492000137	PV ventil Ø150mm	10	<b>8,491</b>
<b>VDA100</b>	4750492000168	PV ventil z vzmetjo Ø100mm	10	<b>6,822</b>
<b>VDA125</b>	4750492000182	PV ventil z vzmetjo Ø125mm	10	<b>7,554</b>
<b>KD100 *</b>	4750492000519	Leseni ventil Ø100mm	10	<b>13,586</b>
<b>KD125 *</b>	4750492000526	Leseni ventil Ø125mm	10	<b>15,431</b>
<b>KD160 *</b>	4750492000533	Leseni ventil Ø160mm	10	<b>14,699</b>
<b>NGA100</b>	4750492106099	PVC rešetka stropna okrogla Ø100mm	10	<b>3,396</b>
<b>NGA125</b>	4750492106105	PVC rešetka stropna okrogla Ø125mm	10	<b>3,924</b>
<b>NGA150</b>	4750492106112	PVC rešetka stropna okrogla Ø150mm	10	<b>3,924</b>

\*Po naročilu \*Odprodaja

## PVC REŠETKE

Koda	EAN	Naziv	Pakiranje (kos)	Cena
<b>ND10FV</b>	4750492011300	PVC zidna rešetka s protipovratno loputo bela, 148 x 153mm, ø100	10	<b>5,153</b>
<b>ND12FV</b>	4750492011348	PVC zidna rešetka s protipovratno loputo bela, 190 x 190mm, ø125	10	<b>5,885</b>
<b>ND15FV</b>	4750492011386	PVC zidna rešetka s protipovratno loputo bela, 190 x 190mm, ø150	10	<b>5,885</b>
<b>N10</b>	4750492000281	PVC fiksna rešetka 148mm x 153mm	10	<b>3,396</b>
<b>N12</b>	4750492000755	PVC fiksna rešetka 190mm x 190mm	10	<b>3,924</b>
<b>ND10</b>	4750492000304	PVC fiksna rešetka 148mm x 153mm, s prirobnico Ø100mm	10	<b>3,396</b>
<b>ND12</b>	4750492000762	PVC fiksna rešetka 190mm x 190mm, s prirobnico Ø125mm	10	<b>3,924</b>
<b>ND15</b>	4750492000816	PVC fiksna rešetka 190mm x 190mm, s prirobnico Ø150mm	10	<b>3,543</b>
<b>N10R</b>	4750492000298	PVC rešetka regulacijska 148mm x 153mm	10	<b>4,128</b>
<b>N12R</b>	4750492000793	PVC rešetka regulacijska 190mm x 190mm	10	<b>4,890</b>
<b>ND10R</b>	4750492000311	PVC rešetka regulacijska 148mm x 153mm, s prirobnico Ø100mm	10	<b>4,128</b>
<b>ND12R</b>	4750492000779	PVC rešetka regulacijska 190mm x 190mm, s prirobnico Ø125mm	10	<b>4,890</b>
<b>ND15R</b>	4750492000823	PVC rešetka regulacijska 190mm x 190mm, s prirobnico Ø150mm	10	<b>4,890</b>
<b>N10A</b>	4750492011577	PVC rešetka pravokotna 150mm x 150mm, antracit	10	<b>7,701</b>
<b>N12A</b>	4750492011591	PVC rešetka pravokotna 190mm x 190mm, antracit	10	<b>10,453</b>
<b>N10G</b>	4750492218433	PVC rešetka stropna kvadratna 148mm x 153mm, Ø100mm	10	<b>3,396</b>
<b>N12G</b>	4750492218457	PVC rešetka stropna kvadratna 190mm x 190mm, Ø125mm	10	<b>3,924</b>
<b>ND10GR *</b>	4750492218488	PVC rešetka stropna kvadratna 150mm x 150mm, regulacijska, Ø125mm	10	<b>4,128</b>
<b>ND12GR</b>	4750492218501	PVC rešetka stropna kvadratna 190mm x 190mm, regulacijska, Ø125mm	10	<b>4,890</b>
<b>ND15GR</b>	4750492218525	PVC rešetka stropna kvadratna 190mm x 190mm, regulacijska, Ø150mm	10	<b>4,890</b>
<b>N10Z</b>	4750492000960	PVC nihajna rešetka 148mm x 153mm Ø100mm	10	<b>3,396</b>
<b>N12Z</b>	4750492000953	PVC nihajna rešetka 190mm x 190mm Ø125mm	10	<b>3,924</b>
<b>ND10Z</b>	4750492000328	PVC nihajna rešetka 148mm x 153mm Ø100mm s prirobnico	10	<b>3,396</b>
<b>ND12Z</b>	4750492000786	PVC nihajna rešetka 190mm x 190mm Ø125mm s prirobnico	10	<b>3,924</b>
<b>ND15Z</b>	4750492000830	PVC nihajna rešetka 190mm x 190mm Ø150mm s prirobnico	10	<b>3,924</b>

\*Po naročilu

\*Oprodaja

## PVC REŠETKE

Koda	EAN	Naziv	Pakiranje (kos)	Cena
<b>N25</b>	47504922000359	PVC rešetka pravokotna 170mm x 250mm	10	<b>3,689</b>
<b>N30</b>	4750492000335	PVC rešetka pravokotna 140mm x 300mm	10	<b>3,689</b>

<b>N25R</b>	4750492000366	PVC rešetka pravokotna regulacijska 170mm x 250mm	10	<b>5,065</b>
-------------	---------------	---	----	--------------

<b>HR1515</b>	4750492219096	PVC rešetka s filtrom 150mm x 150mm	6	<b>7,437</b>
<b>HR2020</b>	4750492219119	PVC rešetka s filtrom 200mm x 200mm	6	<b>9,545</b>
<b>HR2030 *</b>	4750492219133	PVC rešetka s filtrom 200mm x 300mm	6	<b>12,620</b>
<b>HR3030</b>	4750492219140	PVC rešetka s filtrom 300mm x 300mm	6	<b>15,548</b>
<b>HR4030 *</b>	4750492219157	PVC rešetka s filtrom 300mm x 400mm	6	<b>18,739</b>
<b>HR4040</b>	4750492219164	PVC rešetka s filtrom 400mm x 400mm	6	<b>26,938</b>

<b>VR1515</b>	4750492000083	PVC rešetka kvadratna 150mm x 150mm	10	<b>1,610</b>
<b>VR2525</b>	4750492000069	PVC rešetka kvadratna 250mm x 250mm	10	<b>3,543</b>
<b>VR1330</b>	4750492000021	PVC rešetka pravokotna 130mm x 300mm	10	<b>2,255</b>
<b>VR2517 *</b>	4750492000045	PVC rešetka pravokotna 250mm x 170mm	10	<b>2,079</b>
<b>VR459</b>	4750492000106	PVC rešetka pravokotna 450mm x 92mm	15	<b>5,007</b>

<b>VR100</b>	4750492000243	PVC okrogla rešetka Ø100mm	10	<b>1,552</b>
<b>VR125</b>	4750492000250	PVC okrogla rešetka Ø125mm	10	<b>1,845</b>
<b>VR150</b>	4750492010143	PVC okrogla rešetka Ø150mm	10	<b>2,313</b>

## REŠETKE ALUMINIJASTE

Koda	EAN	Naziv	Pakiranje (kos)	Cena
<b>MRA80</b>	4750492104330	Zunanja aluminijasta stenska rešetka Ø80mm	10	<b>10,189</b>
<b>MRA100</b>	4750492104347	Zunanja aluminijasta stenska rešetka Ø100mm	10	<b>5,270</b>
<b>MRA125</b>	4750492104354	Zunanja aluminijasta stenska rešetka Ø125mm	10	<b>6,764</b>
<b>MRA160</b>	4750492104361	Zunanja aluminijasta stenska rešetka Ø160mm	10	<b>10,716</b>
<b>MRA200</b>	4750492104378	Zunanja aluminijasta stenska rešetka Ø200mm	8	<b>15,548</b>
<b>MRA250</b>	4750492104385	Zunanja aluminijasta stenska rešetka Ø250mm	8	<b>28,343</b>
<b>MRA315</b>	4750492104392	Zunanja aluminijasta stenska rešetka Ø315mm	8	<b>47,492</b>

## REŠETKE ALUMINIJASTE VENTILACIJSKE

Koda	EAN	Naziv	Pakiranje (kos)	Cena
<b>RA430S</b>	4750492220801	Rešetka aluminijasta ventilacijska 40 x 300mm, silver	40	<b>6,529</b>
<b>RA640</b>	475092222256	Rešetka aluminijasta ventilacijska 60 x 300mm, bela	40	<b>7,379</b>
<b>RA650S</b>	4750492220955	Rešetka aluminijasta ventilacijska 60 x 500mm, silver	70	<b>8,725</b>
<b>RA850S</b>	4750492221013	Rešetka aluminijasta ventilacijska 80 x 500mm, silver	60	<b>9,926</b>

\*Po naročilu

\*Odprodaja

## REŠETKE BARVANA PLOČEVINA

Koda	EAN	Naziv	Pakiranje (kos)	Cena
<b>MR1010</b>	4750492000373	Pločevinasta rešetka 100 x 100mm, bela	15	<b>4,948</b>
<b>MR1010ZN*</b>	4750492001486	Pločevinasta rešetka 100 x 100mm, cink	15	<b>4,275</b>
<b>MR100</b>	4750492000458	Zunanja stenska rešetka bela Ø100mm	15	<b>3,836</b>
<b>MR125</b>	4750492000465	Zunanja stenska rešetka bela Ø125mm	15	<b>4,451</b>
<b>MR160</b>	4750492000472	Zunanja stenska rešetka bela Ø160mm	15	<b>6,032</b>
<b>MR200</b>	4750492000489	Zunanja stenska rešetka bela Ø200mm	15	<b>8,316</b>
<b>MR2619*</b>	4750492000199	Pločevinasta rešetka 260 x 190mm, regul., bela	15	<b>7,349</b>
<b>MR3010</b>	4750492000229	Pločevinasta rešetka 300 x 100mm, bela	10	<b>7,379</b>
<b>MR5010</b>	4750492104255	Pločevinasta rešetka 500 x 100mm, bela	15	<b>10,453</b>
<b>MR4010R</b>	4750492000502	Pločevinasta rešetka 400 x 100mm, regul., bela	10	<b>12,005</b>

## REŠETKE ZA KAMINE

Koda	EAN	Naziv	Pakiranje (kos)	Cena
<b>MRK1515</b>	4750492103012	Rešetka za kamin 150mm x 150mm	5	<b>17,158</b>
<b>MRK1515A*</b>	4750492212806	Rešetka za kamin 150mm x 150mm, patinirana	5	<b>18,886</b>
<b>MRK1810</b>	4750492104521	Rešetka za kamin 180mm x 100mm	10	<b>15,987</b>
<b>MRK1810A*</b>	4750492212837	Rešetka za kamin 180mm x 100mm, patinirana	10	<b>17,597</b>
<b>MRK1818</b>	4750492102978	Rešetka za kamin 180mm x 180mm	5	<b>20,557</b>
<b>MRK1818A</b>	4750492212851	Rešetka za kamin 180mm x 180mm, patinirana	5	<b>22,633</b>
<b>MRK2512</b>	4750492104538	Rešetka za kamin 250mm x 120mm	8	<b>20,555</b>
<b>MRK2512A</b>	4750492212882	Rešetka za kamin 250mm x 120mm, patinirana	8	<b>22,631</b>
<b>MRK3015</b>	4750492102947	Rešetka za kamin 300mm x 150mm	8	<b>34,287</b>
<b>MRK4018A</b>	4750492212943	Rešetka za kamin 400mm x 180mm, patinirana	8	<b>50,244</b>
<b>MRK2512S*</b>	4750492104569	Kaminska rešetka z okvirjem in sitom 250mm x 120mm	8	<b>28,577</b>
<b>MRK3015S</b>	4750492102954	Kaminska rešetka z okvirjem in sitom 300mm x 150mm	6	<b>43,393</b>
<b>MRK4018S</b>	4750492106709	Kaminska rešetka z okvirjem in sitom 400mm x 180mm	8	<b>57,125</b>
<b>MRK1515R</b>	4750492103036	Nastavljiva rešetka za kamine 150mm x 150mm	5	<b>38,825</b>
<b>MRK1818R</b>	4750492102992	Nastavljiva rešetka za kamine 180mm x 180mm	4	<b>41,109</b>
<b>MRK1818RA*</b>	4750492202875	Nastavljiva rešetka za kamine 180mm x 180mm, patinirana	4	<b>45,238</b>
<b>MRK2512</b>	4750492104538	Nastavljiva rešetka za kamine 250mm x 120mm	8	<b>20,555</b>
<b>MRK2512R</b>	4750492104552	Nastavljiva rešetka za kamine 250mm x 120mm, patinirana	8	<b>39,938</b>
<b>MRK2512RA</b>	4750492212905	Nastavljiva rešetka za kamine 250mm x 120mm, patinirana	8	<b>43,979</b>
<b>MRK3015R*</b>	4750492102961	Nastavljiva rešetka za kamine 300mm x 150mm	6	<b>54,841</b>
<b>MRK3015RA*</b>	4750492212936	Nastavljiva rešetka za kamine 300mm x 150mm, patinirana	6	<b>60,317</b>



\*Odprodaja

## VGRADNA VRATCA

Koda	EAN	Naziv	Pakiranje	Cena
<b>PL1515</b>	4750492105078	PVC vgradna vratca 150mm x 150mm	6	<b>3,46</b>
<b>PL1520</b>	4750492210444	PVC vgradna vratca 150mm x 200mm	6	<b>4,30</b>
<b>PL2020</b>	4750492105092	PVC vgradna vratca 200mm x 200mm	6	<b>5,24</b>
<b>PL2025</b>	4750492105108	PVC vgradna vratca 200mm x 250mm	6	<b>6,76</b>
<b>PL2030</b>	4750492105115	PVC vgradna vratca 200mm x 300mm	6	<b>7,70</b>
<b>PL3030</b>	4750492105122	PVC vgradna vratca 300mm x 300mm	6	<b>8,46</b>
<b>PL4030</b>	4750492219171	PVC vgradna vratca 400mm x 300mm	6	<b>12,62</b>
<b>PL4040</b>	4750492219188	PVC vgradna vratca 400mm x 400mm	6	<b>16,34</b>
<b>RL1515</b>	4750492010044	Pločevinasta vgradna vratca 150mm x 150mm, zunanja	5	<b>11,83</b>
<b>RL2020</b>	4750492100011	Pločevinasta vgradna vratca 200mm x 200mm, zunanja	5	<b>14,17</b>
<b>RL2025</b>	4750492010068	Pločevinasta vgradna vratca 200mm x 250mm, zunanja	5	<b>15,05</b>
<b>RL2030</b>	4750492100028	Pločevinasta vgradna vratca 200mm x 300mm, zunanja	5	<b>16,40</b>
<b>RL3030</b>	4750492100035	Pločevinasta vgradna vratca 300mm x 300mm, zunanja	5	<b>18,59</b>
<b>RL3040</b>	4750492010051	Pločevinasta vgradna vratca 300mm x 400mm, zunanja	5	<b>22,78</b>
<b>RL4040</b>	4750492010075	Pločevinasta vgradna vratca 400mm x 400mm, zunanja	5	<b>27,58</b>
<b>RL4050*</b>	4750492102602	Pločevinasta vgradna vratca 400mm x 500mm, zunanja	5	<b>30,60</b>
<b>RL5050</b>	4750492010235	Pločevinasta vgradna vratca 500mm x 500mm, zunanja	5	<b>37,54</b>
<b>RL6040</b>	4750492010259	Pločevinasta vgradna vratca 600mm x 400mm, zunanja	5	<b>37,54</b>
<b>RLM1515</b>	4750492102619	Pločevinasta revizijska vratca 150mm x 150mm	6	<b>9,28</b>
<b>RLM2015</b>	4750492102626	Pločevinasta revizijska vratca 200mm x 150mm	6	<b>10,04</b>
<b>RLM2020</b>	4750492102633	Pločevinasta revizijska vratca 200mm x 200mm	6	<b>10,37</b>
<b>RLM3030</b>	4750492102664	Pločevinasta revizijska vratca 300mm x 300mm	6	<b>14,41</b>
<b>RLM4050</b>	4750492107287	Pločevinasta revizijska vratca 400mm x 400mm	6	<b>26,50</b>
<b>RLM5050</b>	4750492107300	Pločevinasta revizijska vratca 500mm x 500mm	6	<b>31,48</b>
<b>RLA2020</b>	4750492010167	Pločevinasta vgradna vratca s ključavnico 200mm x 200mm, zunanja	5	<b>18,62</b>
<b>RLA3030</b>	4750492010174	Pločevinasta vgradna vratca s ključavnico 300mm x 300mm, zunanja	5	<b>23,19</b>
<b>RLA3040</b>	4750492102770	Pločevinasta vgradna vratca s ključavnico 300mm x 400mm, zunanja	5	<b>27,35</b>
<b>RLA4040</b>	4750492102787	Pločevinasta vgradna vratca s ključavnico 400mm x 400mm, zunanja	5	<b>32,68</b>
<b>RLA5050</b>	4750492010082	Pločevinasta vgradna vratca s ključavnico 500mm x 500mm, zunanja	5	<b>43,42</b>
<b>RLA6040</b>	4750492010181	Pločevinasta vgradna vratca s ključavnico 600mm x 400mm, zunanja	5	<b>43,42</b>
<b>RLA6060</b>	4750492010099	Pločevinasta vgradna vratca s ključavnico 600mm x 600mm, zunanja	5	<b>45,80</b>
<b>RLMA1515</b>	4750492102671	Pločevinasta vgradna vratca s ključavnico 150mm x 150mm	6	<b>15,54</b>
<b>RLMA2020</b>	4750492102695	Pločevinasta vgradna vratca s ključavnico 200mm x 200mm	6	<b>16,72</b>
<b>RLMA3030</b>	4750492102725	Pločevinasta vgradna vratca s ključavnico 300mm x 300mm	6	<b>21,23</b>
<b>RLMA3040</b>	4750492107331	Pločevinasta vgradna vratca s ključavnico 300mm x 400mm	6	<b>26,50</b>
<b>RLMA4040</b>	4750492107348	Pločevinasta vgradna vratca s ključavnico 400mm x 400mm	6	<b>29,51</b>
<b>MDU2020*</b>	4750492006191	Pločevinasta maskirna vratca za keramiko 200mm x 200mm	6	<b>11,50</b>
<b>MDU2030*</b>	4750492006207	Pločevinasta maskirna vratca za keramiko 200mm x 300mm	6	<b>13,64</b>
<b>MDU2535*</b>	4750492006214	Pločevinasta maskirna vratca za keramiko 250mm x 350mm	6	<b>14,37</b>
<b>MDU5020*</b>	4750492006221	Pločevinasta maskirna vratca za keramiko 500mm x 200mm	6	<b>21,48</b>
<b>RLR2020</b>	4750492219881	Revizijska vratca za mavčne plošče 200mm x 200mm	5	<b>30,45</b>
<b>RLR3030</b>	4750492219898	Revizijska vratca za mavčne plošče 300mm x 300mm	5	<b>36,66</b>
<b>RLR4040</b>	4750492219904	Revizijska vratca za mavčne plošče 400mm x 400mm	5	<b>41,34</b>
<b>RLR6060</b>	4750492219928	Revizijska vratca za mavčne plošče 600mm x 600mm	5	<b>55,78</b>

## STENSKA KLIMATSKA NAPRAVA XTREME SAVE, Wi-fi, BREEZE AWAY FUNKCIJA - set





Koda	Model	Hlajenje (kW)	Ogrevanje (kW)	Energijski razred	(S)EER / (S)COP	Področje delovanja hl./ogr.(°C)	Premer cevi tekoča / plinska faza	Max.dolž.inštalacij / max.višinska razlika(m)	Cena seta
20101726	MSAGAU-09HRFNX-QRD0GW	2,6	2,9	A++ / A+	7,4 / 4,1	-15~50/-15~30	1/4" / 3/8"	25 / 10m	<b>562,22</b>
20101727	MOX102-09HFN8-QRD0GW	zunanja enota							
20101407	MSAGBU-12HRFNX-QRD0GW	3,5	3,8	A++ / A+	7,0 / 4,2	-15~50/-15~30	1/4" / 3/8"	25 / 10m	<b>574,23</b>
20101408	MOX102-12HFN8-QRD0GW	zunanja enota							

## NOTRANJE ENOTE - STENSKE



Koda	Model	Hlajenje (kW)	Ogrevanje (kW)	Cena
20101726	MSAGAU-09HRFNX-QRD0GW	2,6	2,9	Wi-fi Breeze away funkcija <b>206,08</b>
20101401	MSAGBU-12HRFNX-QRD0GW	3,5	3,8	Wi-fi Breeze away funkcija <b>216,09</b>
	MSAGCU-18HRFNX-QRD0GW	5,27	5,6	Wi-fi Breeze away funkcija <b>350,14</b>

## MULTIZUNANJE ENOTE



Koda	Model	Povezuje	Hlajenje (kW)	Ogrevanje (kW)	Energijski razred	(S)EER / (S)COP	Področje delovanja hl./ogr.(°C)	Premer cevi tekoča / plinska faza	Max.dolž.inštalacij / max.višinska razlika (m)	Cena
20101570	M2OE-18FN8-Q	do 2 notranji enoti, el.grelec	5,3	5,6	A++ / A+	6,3 / 4,0	-15~50/-15~24	1/4" / 3/8"	40 / 15m	<b>940,38</b>
	M3OG-21HFN8-Q	do 3 notranje enote, el.grelec	6,1	6,6	A++ / A+	6,1 / 4,0	-15~50/-15~24	1/4" / 3/8"	60 / 15m	<b>1.120,45</b>
20101574	M3OA-27FN8-Q	do 3 notranje enote, el.grelec	7,9	8,2	A++ / A+	4,1 / 4,0	-15~50/-15~24	1/4" / 3/8"	60 / 15m	<b>1.300,52</b>
	M4OG-28FN8-Q	do 4 notranje enote, el.grelec	8,2	8,8	A++ / A+	6,5 / 4,0	-15~50/-15~24	1/4" / 3/8"	80 / 15m	<b>1.520,61</b>
20101547	M4OG-36FN8-Q	do 4 notranje enote, el.grelec	10,55	10,55	A++ / A+	6,5 / 4,0	-15~50/-15~24	1/4" / 3/8"	80 / 10 (15)m	<b>2.200,88</b>

## STROPNE NOTRANJE ENOTE - KASETE



Koda	Model	Hlajenje (kW)	Ogrevanje (kW)	Cena
20723400	MCA3U-12HRFNX-QRD0W (GA)	3,5	4,1	Brezžični + žični daljinec <b>470,19</b>
	MCA3U-18HRFNX-QRD0W (GA)	5,3	5,6	Brezžični + žični daljinec <b>498,20</b>

## STROPNE NOTRANJE ENOTE - KASETNE GARNITURE

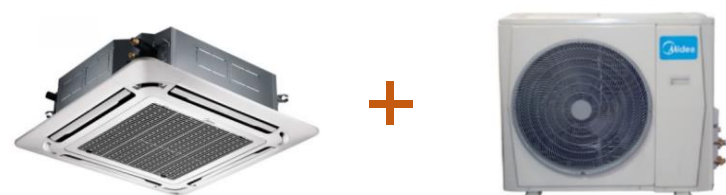

Koda	Model	Hlajenje (kW)	Ogrevanje (kW)	Cena seta
20723400	MCA3U-12HRFNX-QRD0W (GA)	3,5	4,1	notranja enota Brezžični + žični daljinec <b>1.368,47</b>
20723425	MOX230-12HFN8-QRD0W (GA)	zunanja enota		

## AIR-SERNET RAZMAŠČEVALEC ZA ČIŠČENJE OGREVALNIH IN KLIMA NAPRAV



Koda	Volumen (l)	Cena
<b>10199505</b>	5	<b>64,07</b>
EAN:	8436042510139	
<b>10199501</b>	1	<b>13,45</b>

EAN:

Nekislinsko čistilo za čiščenje in vzdrževanje vseh vrst klimatskih in ogrevalnih naprav, za izboljšanje in povečanje učinkovitosti. Odpravlja ostanke in usedline prahu, maščob, olj, ki se lahko pojavijo pri ogrevanju, prezračevanju in klimatizaciji v hladilni industriji. Lahko ga razredčimo z vodo.

## AIRNET DEZINFIKATOR BAKTERICID ZA PRAZRAČEVALNE / HLADILNE SISTEME



Koda	Volumen (l)	Cena
<b>10262550</b>	5	<b>77,00</b>
EAN:	8436042510382	
<b>10262501</b>	0,75	<b>17,41</b>

EAN:

Dezinfikator / baktericid / fungicid je namenjen čiščenju in razkuževanju opreme in instalacij prezračevanja in hlajenja v prehranski industriji. Odstranjuje vse vrste umazanije in oblog, ki nastanejo pri pretoku zraka (mikroorganizme, bakterije, nikotin, prah) brez drgnjenja.

## AIRPUR ODSTRANJEVALEC VONJAV ZA PRAZRAČEVALNE / HLADILNE SISTEME



Koda	Volumen (l)	Cena
<b>10261050</b>	5	<b>116,49</b>
EAN:		
<b>10261001</b>	0,75	<b>20,75</b>
EAN:	8436042510351	

Za odstranjevanje vonjav po čiščenju in razkuževanju opreme in instalacij prezračevanja in hlajenja z AIRNET čistilom v prehranski industriji. Ne uporabljajte v bližini hrane.

## AIR GASLEAK SPREJ DETEKTOR UHAJANJA PLINA



Koda	Volumen (l)	Cena
<b>10332601</b>	0,75	<b>14,75</b>
EAN:	8436042510580	
<b>10332501</b>	0,4	<b>15,70</b>
EAN:		

Detektor dimnih plinov in komprimiranega zraka v spreju. Pokaže tesnost spojev, ventilov, fittingov, regulatorjev in gibljivih cevi na napeljavah. Ni vnetljiv in je primeren za plinske napeljave. Je viskozen in primeren za nanos na različne površine. Vsebuje fluorescentno rdečilo za boljšo vidljivost. Mehurčki pokažejo mesto uhajanja plina.

## SOLARTECH CLEAN ČISTILO ZA SOLARNE IN FOTOVOLTAIČNE PANELE



Koda	Volumen (l)	Cena
<b>10266005</b>	5	<b>67,88</b>
EAN:		
<b>10266001</b>	0,75	<b>19,54</b>
EAN:	8436042511044	

Za čiščenje vseh površin v solarnem in fotovoltaičnem sistemu. Nanos s pršenjem, po 5 minutah splakniti brez drgnjenja. Ustvari zaščitni sloj proti oblogam umazanije in vodnega kamna. Ne pušča sledi na gumi, plastiki in aluminiju. Biorazgradljivo.

## AIR FIRE ZAŠČITNI SPREJ ZA VARJENJE



Koda	Volumen (l)	Cena
<b>103160</b>	0,75	<b>19,68</b>
EAN:	8436042510092	

Za zaščito površin pred visokimi temperaturami pri varjenju. Odbija vročino, prepreči opekline, poškodbe in druge neželjene učinke visokih temperatur. Z izhlapevanjem absorbira vročino na občutljivih površinah, npr. lesu, ploščicah, aluminiju, steklu, plastiki, gumi, fugah, pipah...

## AQ FORTE PLUS KONCENTRIRANI ODMAŠEVALEC ODTOKOV



Koda	Volumen (l)	Cena
<b>10286001</b>	1	<b>13,12</b>
EAN:	8436042510696	

Visoko koncentrirana žveplova kislina (98%) za popolno razgrajevanje organskih snovi (papir, ostanki hrane, krpe, cigaretni ogorki, sanitarne brisače, celuloza, maščobne obloge, lasje) brez korozivnega učinka na odtočno napeljavo, razen reaktivnih kovin, aluminija.. Povzroča potemnitev nerjavečega jekla.

## CREMAN PASTA ZA UMIVANJE ROK



Koda	Teža (kg)	Cena
<b>10171201</b>	1	<b>12,13</b>
EAN:	8436042510078	

Pasta za umivanje rok z učinkovitimi trdnimi delci v kremnem milu, ki olajšajo čiščenje. Nanesite na suhe roke, zdrgnite umazanijo in dobro sperite z vodo.



en vijak

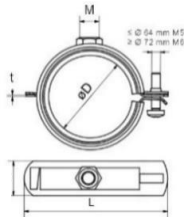

**CEVNA OBJEMKA GUMIRANA en vijak**

Koda	EAN	Navoj	Dimenzije (mm)	Premer (mm)	Pakiranje (kos)	Cena
3X1001216	8595609118833	M8/M10	1/4"	12-16	100	0,911
3X1001719	8595609118840	M8/M10	3/8"	17-19	100	0,976
3X1002023	8595609118857	M8/M10	1/2"	20-23	100	1,028
3X1002530	8595609118864	M8/M10	3/4"	25-30	100	1,077
3X1003138	8595609118871	M8/M10	1"	31-38	100	1,147
3X1004046	8595609118888	M8/M10	5/4"	40-46	100	1,228
3X1004853	8595609118895	M8/M10	6/4"	48-53	50	1,398
3X1006064	8595609118901	M8/M10	2"	60-64	50	1,574



dva vijaka

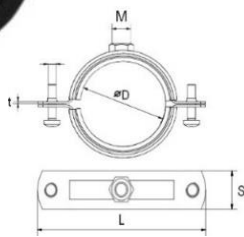

**CEVNA OBJEMKA GUMIRANA dva vijaka**

Koda	EAN	Navoj	Dimenzije (mm)	Premer (mm)	Pakiranje (kos)	Cena
312007278	8595609101347	M8/M10	2 1/2"	72-78	50	2,796
312008792	8595609101361	M8/M10	3"	87-93	50	3,155
312102116	8595609101385	M8/M10	4"	102-116	50	3,683
312121127	8595609101415	M8/M10	4 1/2"	121-127	25	5,167
312133141	8595609101422	M8/M10	5"	133-141	25	5,322
312159168	8595609101439	M8/M10	6"	159-165	25	5,970
312210219	8595609101484	M8/M10	8"	210-219	12	7,010



dva vijaka

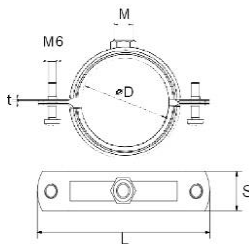

**GUMI OBJEMKA – INOX dva vijaka**

Koda	EAN	Navoj	Dimenzije (mm)	Premer (mm)	Pakiranje (kos)	Cena
315001719	8595609102443	M8	10 (3/8")	17-19	100	4,023
315002023	8595609102450	M8	15 (1/2")	20-23	100	4,019
315002530	8595609102467	M8	20 (3/4")	25-30	100	4,156
315003138	8595609102474	M8	25 (1")	31-38	100	4,287
315004046	8595609102481	M8	32 (5/4")	40-46	100	4,507
315004853	8595609102498	M8	40 (6/4")	48-53	50	4,627
315006064	8595609102511	M8	50 (2")	60-64	50	5,408
315007278	8595609102542	M10	65 (2 1/2")	72-78	50	6,601
315008792*	8595609102566	M10	75 (3")	87-92	50	7,362
315101106*	8595609102634	M10	100 (4")	102-116	50	11,647
315101121*	8595609102658	M10	115 (4 1/2")	121-127	25	12,793
315101133*	8595609102665	M10	125 (5")	133-141	25	13,358
315101159*	8595609102672	M10	150 (6")	159-168	25	14,741

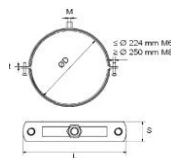

**GUMI OBJEMKE ZA PREZRAČEVANJE dvojne**

Koda	EAN	Navoj	Dimenzije (mm)	Premer (mm)	Nosilnost (N)	Pakiranje (kos)	Cena
318000100	8595609105307	M8/M10	150 x 25 x 1,5	100	600	25	3,391
318000140	8595609105338	M8/M10	190 x 25 x 1,5	140	600	25	4,602
318000160	8595609105352	M8/M10	210 x 25 x 1,5	160	600	25	5,143
318000180	8595609105369	M8/M10	230 x 25 x 1,5	180	600	25	5,273
318000200	8595609105376	M8/M10	250 x 25 x 1,5	200	600	25	6,172
318000250	8595609105406	M8/M10	250 x 25 x 2	250	600	25	7,863

**GUMI OBJEMKE MASIV UNI z univerzalno matico, zvočno izolacijo**

Koda	EAN	Navoj	Dimenzije (mm)	Premer (mm)	Pakiranje (kos)	Cena
317000064*	8595609103365	M12/M16	149 x 40 x 4	60-64	1	3,062
317000071*	8595609103372	M12/M17	157 x 40 x 4	67-71	1	3,074

\*odprodaja!

**GUMI OBJEMKE MASIV dvojne**

Koda	EAN	Navoj	Dimenzije (mm)	Premer (mm)	Pakiranje (kos)	Cena
317108118	8595609103815	M12	210 x 40 x 4	108-118	1	14,387
317108125	8595609103822	M12	227 x 40 x 4	125-130	1	14,999
317133137	8595609103839	M13	228 x 40 x 4	133-137	1	16,331



**CEVNO DRŽALO GUMIRANO DVOJNO Z VIJAKOM M8**

Koda	EAN	Navoj	Dimenzije (mm)	Razmik (mm)	Pakiranje (kos)	Cena
<b>314800015</b>	8595609102375	M8	2 x 15	46	50	<b>2,373</b>
<b>314800018</b>	8595609102382	M8	2 x 18	48	50	<b>2,497</b>
<b>314800022</b>	8595609102399	M8	2 x 22	50	50	<b>2,621</b>
<b>314800028</b>	8595609102405	M8	2 x 28	56	50	<b>2,763</b>

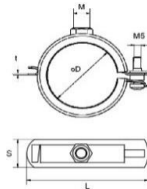

**CEVNE GUMIRANE DRSNE OBJEMKE za PVC cevi - en vijak**

Koda	EAN	Navoj	Dimenzije (mm)	Premer (mm)	Pakiranje (kos)	Cena
<b>313002023</b>	8595609101941	M8	15 (1/2")	20-23	100	<b>1,288</b>
<b>313002530</b>	8595609101958	M8	20 (3/4")	25-30	100	<b>1,314</b>
<b>313003138</b>	8595609101965	M8	25 (1")	31-38	100	<b>1,453</b>

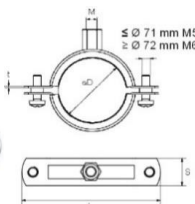

**CEVNE GUMIRANE DRSNE OBJEMKE za PVC cevi - dva vijaka**

Koda	EAN	Navoj	Dimenzije (mm)	Premer (mm)	Pakiranje (kos)	Cena
<b>313007278</b>	8595609102023	M8/M10	65 (2 1/2")	72-78	50	<b>3,322</b>

**CEVNA OBJEMKA rebričasta**

Koda	EAN	Širina (mm)	Premer (mm)	Pakiranje (kos)	Cena
<b>390001016</b>	8595609116792	9	10-16	25	<b>0,599</b>
<b>390001220</b>	8595609116808	9	12-20	25	<b>0,509</b>
<b>390001625</b>	8595609116815	9	16-25	25	<b>0,533</b>
<b>390002032</b>	8595609116822	9	20-32	25	<b>0,555</b>
<b>390005070</b>	8595609116860	9	50-70	25	<b>0,789</b>
<b>390010012</b>	8595609116914	9	100-120	10	<b>1,356</b>
<b>390011013</b>	8595609116921	9	110-130	10	<b>1,470</b>
<b>390014016</b>	8595609116952	9	140-160	10	<b>1,876</b>
<b>390101220</b>	8595609116990	9	12-22	10	<b>0,770</b>
<b>390101625</b>	8595609117003	9	16-27	25	<b>0,784</b>
<b>390102032</b>	8595609117010	9	20-32	25	<b>0,798</b>

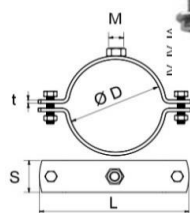
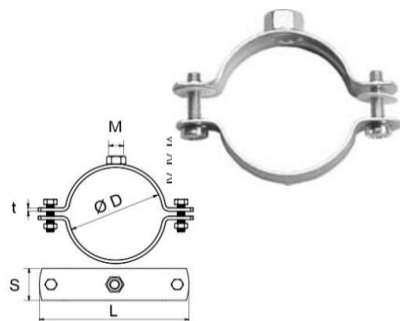

**CEVNA OBJEMKA – BREZ GUME dva vijaka**

Koda	EAN	Navoj	Dimenzije (mm)	Premer (mm)	Nosilnost (N)	Pakiranje (kos)	Cena
<b>314001216</b>	8595609102153	M8	20 (3/4")	22-28	800	100	<b>0,616</b>
<b>314002023</b>	8595609102177	M8	25 (1")	32-35	800	100	<b>0,730</b>
<b>314002530</b>	8595609102184	M8	32 (5/4")	37-42	800	100	<b>0,939</b>
<b>314003138</b>	8595609102191	M8	40 (6/4")	43-50	800	100	<b>0,784</b>
<b>314004853</b>	8595609102214	M8	50 (2")	60-65	2100	50	<b>0,923</b>

**STENSKA KONZOLA pocinkano jeklo**

Koda	EAN	Dolžina (mm)	Dimenzije (mm)	Dim.plošče (mm)	Pakiranje (kos)	Cena
<b>332271820</b>	8595609110424	200	27/18x1,25	120x40x4	20	<b>5,611</b>
<b>332271830</b>	8595609110455	300	27/18x1,25	120x40x4	20	<b>6,529</b>
<b>332271850</b>	8595609110509	500	27/18x1,25	120x40x4	10	<b>8,497</b>
<b>332283020</b>	8595609110523	200	28/30x1,75	120x40x4	10	<b>7,544</b>
<b>332283030</b>	8595609110547	300	28/30x1,75	120x40x4	10	<b>9,462</b>
<b>332283044</b>	8595609110585	440	28/30x1,75	120x40x4	10	<b>11,079</b>
<b>332283050</b>	8595609110592	500	28/30x1,75	120x40x4	10	<b>12,149</b>
<b>332384420</b>	8595609110691	200	38/40x2	120x40x6	10	<b>10,723</b>
<b>332384430</b>	8595609110714	300	38/40x2	120x40x6	10	<b>12,272</b>
<b>332384440</b>	8595609110745	400	38/40x2	120x40x6	7	<b>13,668</b>
<b>332384450</b>	8595609110776	500	38/40x2	120x40x6	7	<b>15,693</b>





**NOSILNA KONZOLA KLS**

Koda	EAN	Dolžina (mm)	Dimenzije (mm)		Pakiranje (kos)	Cena
<b>336020400</b>	8595609112053	400	28/30	lahki	1	<b>21,926</b>
<b>336020600</b>	8595609112077	600	28/30	lahki	1	<b>27,983</b>
<b>336030400</b>	8595609112176	400	38/40	lahki	1	<b>28,732</b>
<b>336030600</b>	8595609112183	600	38/40	lahki	1	<b>34,345</b>

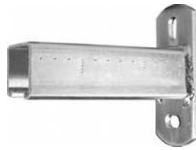

**KRATKA STENSKA KONZOLA ST**

Koda	EAN	Dolžina (mm)	Dimenzije (mm)	Za profil		Pakiranje (kos)	Cena
<b>332841300</b>	8595609111353	300	125x50x5	41/41	težki	1	<b>13,792</b>
<b>332841500</b>	8595609111414	500	125x50x5	41/41	težki	1	<b>17,609</b>



**KRATKA STENSKA KONZOLA**

Koda	EAN	Dimenzije (mm)	Za profil		Pakiranje (kos)	Cena
<b>335000250</b>	8595609111827	120x40x4	7/18, 28/30		50	<b>7,291</b>
<b>335000255</b>	8595609111858	145x60x6	38/40		20	<b>15,990</b>
<b>335000257</b>	8595609111872	145x60x6	38/40, 40/60, 41/62		20	<b>20,627</b>



**NOSILNI PROFIL pocinkano jeklo**

Koda	EAN	Dolžina (mm)	Dimenzije (mm)		Deb.(mm)	Pakiranje (kos)	Cena
<b>331272000</b>	8595609109299	2000	27/18	lahki	1,25	1	<b>12,826</b>
<b>331273000</b>	8595609109305	3000	27/18	lahki	1,25	1	<b>19,280</b>
<b>331283030</b>	8595609109374	3000	28/30	lahki	2,00	1	<b>37,390</b>
<b>331283040</b>	8595609109381	6000	28/30	lahki	2,00	1	<b>76,273</b>
<b>331276000</b>	8595609109336	6000	27/18	lahki	2,00	1	<b>37,561</b>
<b>331384020</b>	8595609109879	2000	38/40	lahki	2,00	1	<b>36,927</b>
<b>331384030</b>	8595609109909	3000	38/40	lahki	2,00	1	<b>55,091</b>
<b>331384063</b>	8595609125282	6000	38/40	lahki	2,00	1	<b>66,578</b>
<b>332712120</b>	8595609111124	2000	41/21	težki	2,50	1	<b>28,541</b>



**PODPORNI ŽLEB pocinkani**

Koda	EAN	Širina x dolžina (mm)		Pakiranje (kos)	Cena
<b>377200120</b>	8595609113128	20 x 2000		10	<b>4,127</b>
<b>377200125</b>	8595609113135	25 x 2000		10	<b>4,535</b>
<b>377200132</b>	8595609113142	32 x 2000		10	<b>5,625</b>
<b>377200140</b>	8595609113159	40 x 2000		10	<b>6,267</b>
<b>377200150</b>	8595609113166	50 x 2000		10	<b>7,564</b>



**MONTAŽNI KOTNIK**

Koda	EAN	Tip	Dimenzije (mm)	Za profil	Pakiranje (kos)	Cena
<b>337002745</b>	8595609112282	27-45°	76 x 100 x 25 x 4	27/18 - 28/30 lahki	50	<b>1,947</b>
<b>337002790</b>	8595609112299	27-90°	87 x 81 x 25 x 4	27/18 - 28/30 lahki	50	<b>1,947</b>
<b>337003890</b>	8595609112312	38-90°	105 x 85 x 40 x 6	38/40, 4 luknje	20	<b>5,609</b>



**H-SPOJKA ZA PROFIL**

Koda	EAN		Za profil	Pakiranje (kos)	Cena
<b>338000010</b>	8595609112343	lahki	27/18 - 28/30	50	<b>7,264</b>
<b>338000015</b>	8595609112374	lahki	38/40	50	<b>9,477</b>



**DRSNI NOSILEC**

Koda	EAN	Navoj	Dolžina (mm)	Za profil	Pakiranje (kos)	Cena
<b>331100830</b>	8595609108780	M8	30	27/18 - 28/30	100	<b>0,744</b>
<b>331100850</b>	8595609108803	M8	50	27/18 - 28/30	100	<b>0,758</b>
<b>331100880</b>	8595609108827	M8	50	27/18 - 28/30	100	<b>0,787</b>
<b>331100881</b>	8595609108834	M8	80	27/18 - 28/30	100	<b>1,195</b>
<b>331100898</b>	8595609108841	M8	100	27/18 - 28/30	100	<b>1,414</b>
<b>331101030</b>	8595609108865	M10	30	38/40	100	<b>1,562</b>
<b>331101051</b>	8595609108896	M10	50	38/40	100	<b>2,008</b>
<b>331101081</b>	8595609108919	M10	80	38/40	100	<b>1,809</b>
<b>331101101</b>	8595609108933	M10	100	38/40	100	<b>1,862</b>
<b>331101851</b>	8595609109039	M8	50	38/40	100	<b>1,985</b>
<b>331101882</b>	8595609109053	M8	80	38/40	100	<b>2,167</b>

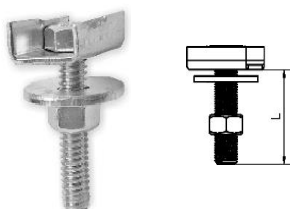

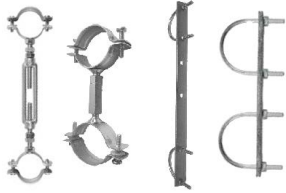

## DRŽALO

Koda	EAN	Dolžina (mm)	Tip	Razpon (mm)	Pakiranje (kos)	Cena
350125054	8595609112497	5/4"	250 dolga	100	25	4,944
350324001	8595609112527	1"	100 dolga nastavljiva	200 - 240	25	11,269
350410054	8595609112558	5/4"	100 kratka	85 - 105	50	6,460



## TRAPEZNI NOSILEC

Koda	EAN	Navoj	Tip	Dimenzije (mm)	Pakiranje (kos)	Cena
322030025	8595609107288	M8	z gumico	25 x 2	100	2,751
322010010	8595609107264	M10	z matico	25 x 2	100	1,620
322000008	8595609107233	M8	regulacijski	25 x 2	100	2,654
322040000	8595609107516	M8	tip ZV	67 x 30 x 2,5	500	2,062



## ZIDNI NAVOJNI NOSILEC

Koda	EAN	Navoj	Dimenzije ploščice (mm)	Pakiranje (kos)	Cena
360710122	8595609112992	M10 x 120	40 x 40 x 2,5	50	1,567
360710123	8595609113005	M10 x 120	40 x 40 x 2,5	50	0,868



## KOTNI NOSILEC

Koda	EAN	Odprtina (mm)	Višina (mm)	Za profil	Pakiranje (kos)	Cena
338002718	8595609112428	M6	85	27/18 - 28/30	25	5,954
338003840	8595609112435	M10	118	40/60 - 41/62	20	6,562



## DRSNI SPOJNIK

Koda	EAN	Odprtina (mm)	Dimenzije (mm)	Za profil	Pakiranje (kos)	Cena
331527105	8595609110400	10,5	30 x 25 x 2,5	27/18 - 28/30	100	0,570
331500027	8595609110301	8,4	30 x 25 x 4	27/18 - 28/30	100	0,708
331500038	8595609110318	10,5	40 x 38 x 4	38/40	100	1,081



## DRSNA MATICA

Koda	EAN	Navoj	Za profil	Pakiranje (kos)	Cena
332902108	8595609138725	M8	M8 x 6 41/21 - 41/62	100	1,631



## PODLOŽKA

Koda	EAN	Navoj	Pakiranje (kos)	Cena
331300308	8595609109497	M8 široka	100	0,106
331304008	8595609109534	M8	100	0,170
331304010	8595609109541	M10	100	0,177
331304012	8595609109558	M12	100	0,374

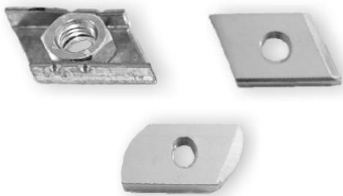

## NAVOJNA PODLOŽKA za drsni nosilec (drsni spojnik)

Koda	EAN	Navoj	Za profil	Pakiranje (kos)	Cena
331227108	8595609109176	M8	27/18 - 28/30	100	0,335
331227110	8595609109190	M10	27/18 - 28/30	100	0,429
331228308	8595609109213	M8	38/40	100	0,737
331228310	8595609109220	M10	38/40	100	0,737



## NAVOJNO OBEŠALO

Koda	EAN	Navoj	Odprtina (mm)	Pakiranje (kos)	Cena
321200008	8595609106854	M8	8,5	100	1,145
321200010	8595609106861	M10	10,5	100	1,384
321200012	8595609106878	M12	12,5	100	1,943



## ZIDNI OJAČITVENI NOSILEC

Koda	EAN	Navoj	Dimenzije (mm)	Pakiranje (kos)	Cena
321600854	8595609106885	M8	z matico 78 x 25 x 2,5	100	0,801
321600885	8595609106892	M8	z matico 120 x 40 x 4	50	3,146
321601054	8595609106908	M10	z matico 78 x 25 x 2,5	100	0,936
321601085	8595609106915	M10	z matico 120 x 40 x 4	50	2,972
321601087	8595609106922	M12	z matico 120 x 40 x 4	50	5,259



**NOSILNA SPONA**

Koda	EAN	Navoj	Za profil (mm)	Max.obt.(N)	Pakiranje (kos)	Cena
321700102	8595609107172	M8	0-18	1200	50	2,677
321700010	8595609107158	M10	0-20	2500	50	3,521
321700012	8595609107165	M12	0-20	3500	50	4,588



**VERIGA**

Koda	EAN	Naziv	Debelina (mm)	Nosilnost (kg)	Pakiranje (kos)	Cena
3R085A004	8595609118215	Veriga varjena pocinkar	4	125	30	6,128



**VRV JEKLENA**

Koda	EAN	Naziv	Debelina (mm)	Nosilnost (N)	Pakiranje (m)	Cena
3R2500004	8595609118789	Vrv jeklena	4	14900	100	2,329



**SPONA ZA ŽIČNO VRV**

Koda	EAN	Naziv	Pakiranje (kos)	Cena
3R2060002	8595609118567	Spona za žično vrv 4 - 5mm	50	0,584



**PERFORIRAN TRAK V KOLUTU**

Koda	EAN	Dimenzije (mm)	Pakiranje (kos)	Cena
321800017	8595609107219	17mm x 10m	10	10,223



**NAVOJNA PALICA**

Koda	EAN	Navoj	Dolžina (mm)	Pakiranje (kos)	Cena
322038121	8595609107318	M6	1000	100	1,643
322038223	8595609136912	M8	1000	50	1,548
322038224	8595609136929	M10	1000	25	3,334
322121000	8595609107561	M12	1000	20	5,532
322440803	8595609108261	M8	3000	25	5,399
322441003	8595609108278	M10	3000	25	9,116



**HANGAR VIJAK (KOMBI - TORX)**

Koda	EAN	Navoj	L (mm)	La / Lb (mm)	Pakiranje (kos)	Cena
321008060	8595609106625	M8 x 60 Torx	60	28/21	100	0,121
321008080	8595609106649	M8 x 80 Torx	80	37/30	100	0,156
321008100	8595609106656	M8 x 100 Torx	100	45/40	100	0,208
321008120	8595609106663	M8 x 120 Torx	120	47/50	100	0,256
321008140	8595609106670	M8 x 140 Torx	140	47/50	100	0,420
321008160	8595609106687	M8 x 160 Torx	160	47/50	100	0,343
321010080	8595609106717	M10 x 80 Torx	80	40/30	100	0,266
321010100	8595609106724	M10 x 100 Torx	100	57/30	100	0,326
321010120	8595609106731	M10 x 120 Torx	120	57/40	100	0,389
321010140	8595609106748	M10 x 140 Torx	140	57/40	50	0,476

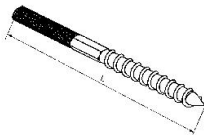

**VIJAK Z METRIČNIM NAVOJEM**

Koda	Navoj	Dolžina (mm)	Pakiranje (kos)	Cena	Koda	Navoj	Dolžina (mm)	Pakiranje (kos)	Cena
385606030	M6	30	100	0,096	385612030	M12	30	50	0,515
385608020	M8	20	100	0,168	385612050	M12	50	50	0,778
385608025	M8	25	100	0,198	385612080	M12	80	50	1,028
385608030	M8	30	100	0,224	385616055	M16	55	25	1,547
385608040	M8	40	100	0,244	385616060	M16	60	20	1,394
385608070	M8	70	100	0,348	385616065	M16	65	30	1,728
385608100	M8	100	100	0,617	385616070	M16	70	30	1,449
385610025	M10	25	100	0,360	385616080	M16	80	30	2,074
385610030	M10	30	100	0,440	385616090	M16	90	30	2,551
385610040	M10	40	100	0,447					



**MATICA REDUCIRNA**

Koda	EAN	Navoj	Dolžina (mm)	Pakiranje (kos)	Cena
325001012	8595609108681	M10/M12	21	10	2,353
325001208	8595609108698	M12/M8	23	10	2,692
325001210	8595609108704	M12/M10	23	10	2,748
325104812	8595609108742	M8/M12		10	2,203





**MATICA**

Koda	Navoj	Pakiranje (kos)	Cena	Koda	Navoj	Pakiranje (kos)	Cena
331400006	M6	100	0,035	331400012	M12	50	0,152
331400008	M8	100	0,046	331400016	M16	50	0,331
331400010	M10	100	0,104				



**MATIČNA SPOJKA za ogrodni vijak**

Koda	EAN	Navoj	Ključ	Dimenzije (mm)	Pakiranje (kos)	Cena
324081330	8595609108599	M8	13	30	100	0,323
324101320	8595609108605	M10	13	25	50	0,270
324101730	8595609108612	M10	17	30	50	0,508



**TRIGLAV VLOŽEK**

Koda	EAN	Navoj	Ø vrtanja (mm)	Gl.vrtanja (mm)	Pakiranje (kos)	Cena
380501007	8595609113401	M6	8	30	100	0,314
380501008	8595609121178	M8	10	30	100	0,293
380501009	8595609113418	M8	z robom	32	100	0,292
380501010	8595609126159	M10	12	42	100	0,405
380501012	8595609126166	M12	15	53	50	1,276



**ZIDNI VLOŽEK ZA KNAUF**

Koda	EAN	Dimenzije (mm)	Gl.vrtanja(mm)	Pakiranje (kos)	Cena
383010350	8595609114538	10 x 35	3,5 - 4 PVC	100	0,136
383010351	8595609114545	10 x 35	3,5 - 4 pocinkan	100	0,451



**VIJAK STOJALNI, DIN 571**

Koda	EAN	Dimenzije (mm)	Pakiranje (kos)	Cena
382180070	8595609114286	M8 x 70	100	0,266
382180120	8595609114316	M8 x 120	25	0,441



**VIJAK SAMOREZNI**

Koda	EAN	Dimenzije (mm)	Pakiranje (kos)	Cena
385601413	8595609115818	4,2 x 13	200	0,031
385601416	8595609115825	4,2 x 16	200	0,032
388542019	8595609116679	4,2 x 19 glava	200	0,038
385600519	8595609115689	4,8 x 19 glava	200	0,049



**SPAX VIJAK**

Koda	EAN	Dimenzije (mm)	Pakiranje (kos)	Cena
382140040	8595609114019	4 x 40	500	0,041
382140050	8595609126258	4 x 50	500	0,049
382150040	8595609114033	5 x 40	500	0,049
382150050	8595609114040	5 x 50	500	0,058
382150060	8595609114057	5 x 60	200	0,072
382150070	8595609114064	5 x 70	200	0,101
382160070	8595609114194	6 x 70	200	0,136



**VIJAK ZA SIDRANJE V BETON**

Koda	EAN	Navoj	Dolžina (mm)	Gl.vrtanja(mm)	Pakiranje (kos)	Cena
380700810	8595609113593	M8	75	60 8/10+23/76	50	0,991
380700830	8595609113609	M8	90	60 8/30+43/96	50	0,968
380701005	8595609113616	M10	70	50 10.05.1969	50	1,148
380701015	8595609113623	M10	90	70 10/15+23/89	50	1,458



**MOLLY VIJAK s kovinskim vložkom za votle stene**

Koda	EAN	Navoj	Dolžina (mm)	Pakiranje (kos)	Cena
380480613	8595609123653	M6	37	100	1,111
380480616	8595609123660	M6	50	100	1,121
380480624	8595609123677	M6	65	100	1,133
380480638	8595609123684	M6	80	100	1,194
380480816	8595609126128	M8	55	100	1,372
380480832	8595609126135	M8	65	100	1,539



**ZAKLJUČNI ČEPI PVC za profile**

Koda	EAN	Za profil	Pakirano (kos)	Cena
333002718	8595609111759	27/18	100	0,282
333002830	8595609111766	28/30	100	0,316
333004020	8595609110998	41/21	100	0,532



**DRŽALA ZA BAKRENE CEVI PVC**



Koda	EAN	Premer (mm)	Pakiranje (kos)	Cena
384004015	8595609115009	enojno 15	50	0,220
384004018	8595609115016	enojno 18	50	0,154
384004022	8595609115023	enojno 22	50	0,175
384004215	8595609115078	dvojno 2 x 15	50	0,483
384004218	8595609115092	dvojno 2 x 18	50	0,577
384004222	8595609115115	dvojno 2 x 22	50	0,600
384014015	8595609128405	enojno z zaporko 15	50	0,129
384014018	8595609128412	enojno z zaporko 18	50	0,148
384014022	8595609128429	enojno z zaporko 22	50	0,175
384004028	8595609115030	enojno z zaporko 28	50	0,359
384004035	8595609115054	enojno z zaporko 35	50	0,791
384024015	8595609128443	dvojno z zaporko 2 x 15	50	0,453
384024018	8595609128450	dvojno z zaporko 2 x 18	50	0,553
384024022	8595609128467	dvojno z zaporko 2 x 22	50	0,386
384024028	8595609128474	dvojno z zaporko 2 x 28	50	0,690

**ROZETE PVC ENOJNE**



Koda	Ø(mm)	Pakiranje (kos)	Cena	Koda	Ø(mm)	Pakiranje (kos)	Cena
384006012	D12 bela	50	0,464	384006215	D15 krom	50	1,419
384006015	D15 bela	50	0,427	384006218	D18 krom	50	1,419
384006018	D18 bela	50	0,277	384006222	D22 krom	50	1,378
384006022	D22 bela	50	0,417	384006228	D28 krom	50	1,291

**OBJEMKA ZA FIKSIRANJE DOVODNIH CEVI**



Koda	EAN	Dimenzije	Pakiranje (kos)	Cena
384182575	8595609115436	enojna N1 x 25 - 8/75	50	0,409
384183295	8595609115467	enojna N1 x 32 - 8/95	50	0,466
384283275	8595609115498	dvojna N2 x 32 - 8/75	50	0,496

**SKOBE ZA TALNO OGREVANJE**



Koda	EAN	Pakiranje (kos)	Cena/kos
390000305	8595609116747	tip C ročna	50 0,251
390000306	8595609116754	tip D pištolska	50 0,172

**VEZICE bele**



Koda	Dimenzije (mm)	Pakiranje (kos)	Cena	Koda	Dimenzije (mm)	Pakiranje (kos)	Cena
319625100	2,5 x 100	100	0,017	319635300	3,5 x 300	100	0,130
319625120	2,5 x 120	100	0,038	319635370	3,5 x 370	100	0,192
319625160	2,5 x 160	100	0,039	319648190	4,8 x 190	100	0,110
319625200	2,5 x 200	100	0,063	319648280	4,8 x 280	100	0,172
319635150	3,5 x 150	100	0,047	319648380	4,8 x 380	100	0,198
319635200	3,5 x 200	100	0,065	319648430	4,8 x 430	100	0,368
319635250	3,5 x 250	100	0,175				

**HITROSUŠEČA MALTA V TUBI**



Koda	EAN	Naziv	Pakiranje (kos)	Cena
381650300	8595609113869	Hitrosušiča malta tuba 280ml z nastavkom	1	37,209
381660000	8595609113906	Nastavek konica za tubo 280ml rezervni	1	1,898
381650304	8595609113883	Pištola za tubo 280ml	1	63,979

**ZIDNI VLOŽEK ZA HITROSUŠEČO MALTO**



Koda	EAN	Za vijak	Dolž.(mm)	Ø(mm)	Pakiranje (kos)	Cena
381611685	8595609113777	M8, M10, M12	85	16	4	1,342

**REZALKA**

Koda	EAN	Dimenzije (mm)	za rezanje	Pakiranje (kos)	Cena
394100122	8595609132693	125 x 1,0	TOP INOX jeklo / inox	1	4,849
394101228	8595609132716	230 x 1,9	TOP INOX jeklo / inox	1	12,516

\*Po naročilu

## IST CEV ALUMPLAST (v kolotu)



Koda	Dimenzije (mm)	Temp.(C°) / Tlak (bar)	V kolotu (m)	Cena / m
<b>MULTIC.16-R200</b>	16 x 2	20°C/25bar - 90°C/10bar	200	<b>1,31</b>
<b>MULTIC.16-R450</b>	16 x 2	20°C/25bar - 90°C/10bar	450	<b>1,31</b>
<b>MULTIC.20-R50</b>	20 x 2	20°C/25bar - 90°C/10bar	50	<b>1,64</b>
<b>MULTIC.25-R50</b>	25 x 2,5	* 20°C/25bar - 90°C/10bar	50	<b>3,57</b>
<b>MULTIC.32-R50</b>	32 x 3	20°C/25bar - 90°C/10bar	50	<b>5,57</b>

## IST CEV PREDIZOLIRANA ALUMPLAST (v kolotu)



Koda	Dimenzije (mm)	Temp.(C°) / Tlak (bar)	Izolacija(mm)	V kolotu (m)	Cena / m
<b>MC16AIS6-A</b>	16 x 2	20°C/25bar - 90°C/10bar	6 - modra	50	<b>1,89</b>
<b>MC20AIS6-A</b>	20 x 2	20°C/25bar - 90°C/10bar	6 - modra	50	<b>2,61</b>
<b>MC25AIS10-A</b>	25 x 2,5	20°C/25bar - 90°C/10bar	10 - modra	25	<b>4,68</b>
<b>MC32AIS-A</b>	32 x 3	20°C/25bar - 90°C/10bar	10 - modra	25	<b>7,99</b>

## IST CEV ALUMPLAST (palice)



Koda	Dimenzije (mm)	Temp.(C°) / Tlak (bar)	Palica (m)	Cena / m
<b>MULTIC.16-B</b>	16 x 2	20°C/25bar - 90°C/10bar	4	<b>1,59</b>
<b>MULTIC.20-B</b>	20 x 2	20°C/25bar - 90°C/10bar	4	<b>2,46</b>
<b>MULTIC.25-B</b>	25 x 2,5	20°C/25bar - 90°C/10bar	4	<b>4,51</b>
<b>MULTIC.32-B</b>	32 x 3	20°C/25bar - 90°C/10bar	4	<b>7,39</b>

## ISTP BATERIJSKI PRIKLJUČEK notranji navoj



Koda	Dimenzije (mm)	Cena
<b>CSH16X1/2</b>	16 x 1/2"	<b>6,14</b>
<b>CSH20X1/2</b>	20 x 1/2"	<b>7,03</b>
<b>CSH20X3/4</b>	20 x 3/4"	<b>8,86</b>
<b>CSH25X3/4</b>	25 x 3/4"	<b>9,38</b>



## ISTP KOLENO

Koda	Dimenzije (mm)	Cena
<b>C16</b>	16	<b>3,90</b>
<b>C20</b>	20	<b>4,76</b>
<b>C25</b>	25	<b>7,79</b>
<b>C32</b>	32	<b>11,96</b>

## ISTP SPOJKA



Koda	Dimenzije (mm)	Cena
<b>U16</b>	16	<b>2,99</b>
<b>U20</b>	20	<b>4,09</b>
<b>U25</b>	25	<b>6,30</b>
<b>U32</b>	32	<b>9,21</b>

## ISTP REDUCIRNA SPOJKA



Koda	Dimenzije (mm)	Cena
<b>R20X16</b>	20 x 16	<b>3,90</b>
<b>R25X16</b>	25 x 16	<b>5,55</b>
<b>R25X20</b>	25 x 20	<b>5,67</b>
<b>R32X16</b>	32 x 16	<b>8,15</b>
<b>R32X20</b>	32 x 20	<b>8,17</b>
<b>R32X25</b>	32 x 25	<b>8,42</b>

## P. PRITRDILNA PLOŠČA M za baterijski priključek



Koda	Dimenzije (mm)	Cena
<b>1073</b>	M1 dvojna	<b>4,33</b>
<b>1075</b>	M2 enojna	<b>3,78</b>
<b>1076</b>	M3 ravna	<b>3,42</b>

## ISTP KOLENO zunanji navoj

Koda	Dimenzije (mm)	Cena
<b>CM16X1/2</b>	16 x 1/2"	<b>4,61</b>
<b>CM16X3/4</b>	16 x 3/4"	<b>5,01</b>
<b>CM20X1/2</b>	20 x 1/2"	<b>5,36</b>
<b>CM20X3/4</b>	20 x 3/4"	<b>6,01</b>
<b>CM25X1/2</b>	25 x 1/2"	<b>6,98</b>
<b>CM25X3/4</b>	25 x 3/4"	<b>7,86</b>
<b>CM25X1</b>	25 x 1"	<b>10,02</b>
<b>CM32X1</b>	32 x 1"	<b>11,19</b>

## ISTP KOLENO notranji navoj

Koda	Dimenzije (mm)	Cena
<b>CH16X1/2</b>	16 x 1/2"	<b>4,12</b>
<b>CH16X3/4</b>	16 x 3/4"	<b>5,43</b>
<b>CH20X1/2</b>	20 x 1/2"	<b>4,72</b>
<b>CH20X3/4</b>	20 x 3/4"	<b>5,98</b>
<b>CH25X1/2</b>	25 x 1/2"	<b>6,60</b>
<b>CH25X3/4</b>	25 x 3/4"	<b>7,40</b>
<b>CH25X1</b>	25 x 1"	<b>9,34</b>
<b>CH32X3/4</b>	32 x 3/4"	<b>8,86</b>
<b>CH32X1</b>	32 x 1"	<b>11,41</b>



### ISTP T-KOS

Koda	Dimenzije (mm)	Cena
<b>T16</b>	16	<b>4,42</b>
<b>T20</b>	20	<b>6,33</b>
<b>T25</b>	25	<b>11,51</b>
<b>T32</b>	32	<b>16,07</b>



### ISTP T-KOS notranji navoj

Koda	Dimenzije (mm)	Cena
<b>TH16X1/2</b>	16 x 1/2" x 16	<b>6,18</b>
<b>TH20X1/2</b>	20 x 1/2" x 20	<b>6,92</b>
<b>TH20X3/4</b>	20 x 3/4" x 20	<b>8,48</b>
<b>TH25X1/2</b>	25 x 1/2" x 25	<b>10,83</b>
<b>TH25X3/4</b>	25 x 3/4" x 25	<b>10,86</b>
<b>TH25X1</b>	25 x 1" x 25	<b>13,32</b>
<b>TH32X3/4</b>	32 x 3/4" x 32	<b>16,17</b>
<b>TH32X1</b>	32 x 1" x 32	<b>16,35</b>



### ISTP TT-KOS

Koda	Dimenzije (mm)	Cena
<b>DC25202020</b>	25x20x20x20	<b>12,12</b>
<b>DC25201616</b>	25x20x16x16	<b>10,60</b>
<b>DC20201616</b>	20x20x16x16	<b>8,63</b>
<b>DC20202020</b>	20x20x20x20	<b>10,70</b>
<b>DC20162016</b>	20x16x20x16	<b>9,41</b>



### ISTP PREHODNI KOS PRESS na ZUNANJI NAVOJ

Koda	Dimenzije (mm)	Cena
<b>EM16X3/8</b>	16 x 3/8"	<b>2,71</b>
<b>EM16X1/2</b>	16 x 1/2"	<b>2,87</b>
<b>EM16X3/4</b>	16 x 3/4"	<b>4,01</b>
<b>EM20X1/2</b>	20 x 1/2"	<b>3,28</b>
<b>EM20X3/4</b>	20 x 3/4"	<b>4,35</b>
<b>EM20X1</b>	20 x 1"	<b>5,66</b>
<b>EM25X1/2</b>	25 x 1/2"	<b>5,01</b>
<b>EM25X3/4</b>	25 x 3/4"	<b>5,53</b>
<b>EM25X1</b>	25 x 1"	<b>6,72</b>
<b>EM32X3/4</b>	32 x 3/4"	<b>6,66</b>
<b>EM32X1</b>	32 x 1"	<b>7,66</b>
<b>EM32X1-1/4</b>	32 x 1 1/4"	<b>10,18</b>



### ISTP PREHODNI KOS PRESS na NOTRANJI NAVOJ

Koda	Dimenzije (mm)	Cena
<b>EH16X1/2</b>	16 x 1/2"	<b>3,39</b>
<b>EH16X3/4</b>	16 x 3/4"	<b>3,88</b>
<b>EH20X1/2</b>	20 x 1/2"	<b>3,55</b>
<b>EH20X3/4</b>	20 x 3/4"	<b>4,45</b>
<b>EH20X1</b>	20 x 1"	<b>6,18</b>
<b>EH25X1/2</b>	25 x 1/2"	<b>5,17</b>
<b>EH25X3/4</b>	25 x 3/4"	<b>5,37</b>
<b>EH25X1</b>	25 x 1"	<b>7,26</b>
<b>EH32X3/4</b>	32 x 3/4"	<b>6,21</b>
<b>EH32X1</b>	32 x 1"	<b>7,99</b>



### ISTP T-KOS reducirni

Koda	Dimenzije (mm)	Cena
<b>TR20X16X20</b>	20 x 16 x 20	<b>6,47</b>
<b>TR20X16X16</b>	20 x 16 x 16	<b>6,44</b>
<b>TR16X20X16</b>	16 x 20 x 16	<b>6,47</b>
<b>TR16X25X16</b>	16 x 25 x 16	<b>6,95</b>
<b>TR20X20X16</b>	20 x 20 x 16	<b>6,47</b>
<b>TR25X20X25</b>	25 x 20 x 25	<b>11,33</b>
<b>TR25X20X20</b>	25 x 20 x 20	<b>9,88</b>
<b>TR20X25X20</b>	20 x 25 x 20	<b>9,94</b>
<b>TR25X25X20</b>	25 x 25 x 20	<b>10,26</b>
<b>TR25X16X25</b>	25 x 16 x 25	<b>10,13</b>
<b>TR25X20X16</b>	25 x 20 x 16	<b>9,39</b>
<b>TR25X16X20</b>	25 x 16 x 20	<b>9,58</b>
<b>TR25X32X25</b>	25 x 32 x 25	<b>15,68</b>
<b>TR25X16X16</b>	25 x 16 x 16	<b>7,61</b>
<b>TR32X25X32</b>	32 x 25 x 32	<b>15,62</b>
<b>TR32X25X25</b>	32 x 25 x 25	<b>15,13</b>
<b>TR32X20X32</b>	32 x 20 x 32	<b>15,25</b>
<b>TR32X25X20</b>	32 x 25 x 20	<b>15,07</b>
<b>TR32X16X32</b>	32 x 16 x 32	<b>15,68</b>
<b>TR32X32X25</b>	32 x 32 x 25	<b>15,98</b>



### ISTP PRIKLJUČEK ZA RADIATOR

Koda	Dimenzije (mm)	Cena
<b>CR16X15</b>	16 x 15	<b>15,84</b>



### ISTP PREHODNI KOS Cu na Alu

Koda	Cev Cu na Alu	Cena
<b>AD/C12-M16</b>	12 na 16 x 2	<b>1,84</b>
<b>AD/C15-M16</b>	15 na 16 x 2	<b>2,37</b>
<b>AD/C18-M16</b>	18 na 16 x 2	<b>2,62</b>
<b>AD/C15-M20</b>	15 na 20 x 2	<b>3,17</b>
<b>AD/C18-M20</b>	18 na 20 x 2	<b>3,57</b>
<b>AD/C22-M20</b>	22 na 20 x 2	<b>3,72</b>
<b>AD/C22-M25</b>	22 na 25 x 2,5	<b>4,72</b>
<b>AD/C28-M25</b>	28 na 25 x 2,5	<b>5,66</b>
<b>AD/C28-M32</b>	28 na 32 x 3	<b>6,27</b>



### ISTP PREHODNI KOS PRESS na HOLANDEC

Koda	Dimenzije (mm)	Cena
<b>RM16X1/2</b>	16 x 1/2"	<b>3,39</b>
<b>RM16X3/4</b>	16 x 3/4"	<b>4,58</b>
<b>RM20X1/2</b>	20 x 1/2"	<b>3,80</b>
<b>RM20X3/4</b>	20 x 3/4"	<b>5,20</b>
<b>RM20X1</b>	20 x 1"	<b>7,44</b>
<b>RM25X1/2</b>	25 x 1/2"	<b>7,68</b>
<b>RM25X3/4</b>	25 x 3/4"	<b>8,38</b>
<b>RM25X1</b>	25 x 1"	<b>11,75</b>
<b>RM32X1</b>	32 x 1"	<b>13,14</b>





### ISTP ČEP PRESS

Koda	Dimenzije (mm)	Cena
<b>TAP-P16</b>	16 x 2	<b>2,29</b>



### ISTP INOX SPOJKA

Koda	Dimenzije (mm)	Cena
<b>CI16</b>	16	<b>0,74</b>
<b>CI20</b>	20	<b>0,77</b>
<b>CI25</b>	25	<b>1,16</b>
<b>CI32</b>	32	<b>1,38</b>



### ISTP ČEP VIJAČNI

Koda	Dimenzije (mm)	Cena
<b>TAP16R</b>	16	<b>3,57</b>



### ISTP EUROKONUS

Koda	Dimenzije (mm)	Cena
<b>EURMC16X3/4</b>	16 x 3/4"	<b>4,66</b>
<b>EURMC20X3/4</b>	20 x 3/4"	<b>5,29</b>



### ISTP PODOMETNI KROGELNI VENTIL

Koda	Dimenzije (mm)	Cena
<b>VAL16</b>	16 x 2	<b>15,49</b>
<b>VAL20</b>	20 x 2	<b>18,79</b>
<b>VAL25</b>	25 x 2	<b>21,01</b>
<b>VAL32</b>	32 x 2	<b>23,92</b>



### ISTP KALIBRATOR

Koda	Dimenzije (mm)	Cena
<b>A161820</b>	16-18-20	<b>20,00</b>
<b>A202532</b>	20-25-32	<b>21,43</b>



### ISTP KROGELNI VENTIL

Koda	Dimenzije (mm)	Cena
<b>VAL-LIN16</b>	16 x 2	<b>11,09</b>
<b>VAL-LIN20</b>	20 x 2	<b>11,93</b>
<b>VAL-LIN25</b>	25 x 2	<b>18,40</b>
<b>VAL-LIN32</b>	32 x 3	<b>22,05</b>



### ISTP VZMET NOTRANJA

Koda	Dimenzije (mm)	Cena
<b>MUELLE1216</b>	16	<b>8,72</b>
<b>MUELLE1620</b>	20	<b>9,43</b>
<b>MUELLE2025</b>	25	<b>10,43</b>
<b>MUELLE2632</b>	32	<b>15,92</b>



### ISTP KAPA VENTILA Z ROZETO

Koda	Dimenzije (mm)	Cena
<b>MO</b>	16	<b>6,01</b>



### ISTP VZMET ZUNANJA

Koda	Dimenzije (mm)	Cena
<b>MUELL-EX16</b>	16	<b>12,22</b>
<b>MUELL-EX20</b>	20	<b>14,62</b>
<b>MUELL-EX25</b>	25	<b>16,36</b>
<b>MUELL-EX32</b>	32	<b>20,93</b>



### ISTP PVC OBROČEK

Koda	Dimenzije (mm)	Cena
<b>JE16</b>	16	<b>0,50</b>
<b>JE20</b>	20	<b>0,54</b>
<b>JE25</b>	25	<b>0,56</b>
<b>JE32</b>	32	<b>0,61</b>



### ISTP GUMI TESNILO

Koda	Dimenzije (mm)	Cena
<b>JG16</b>	16	<b>0,57</b>
<b>JG20</b>	20	<b>0,57</b>
<b>JG25</b>	25	<b>0,65</b>
<b>JG32</b>	32	<b>0,65</b>



### ISTP KLEŠČE za alumplast

Koda	Dimenzije (mm)	Cena
<b>TIJ 16-32</b>	16-32	<b>21,35</b>



### ISTP LUBRIFIKATOR

Koda	Cena
<b>L-400</b> za vlaženje spojev	<b>24,29</b>

## ISTV BATERIJSKI PRIKLJUČEK



Koda	Dimenzije (mm)	Cena
<b>CSHCO1612</b>	16 x 1/2"	<b>6,71</b>
<b>CSHCO2012</b>	20 x 1/2"	<b>8,91</b>

## ISTV SPOJKA



Koda	Dimenzije (mm)	Cena
<b>UCO16</b>	16	<b>5,67</b>
<b>UCO20</b>	20	<b>9,33</b>
<b>UCO25</b>	25	<b>16,35</b>
<b>UCO32</b>	32	<b>19,95</b>

## ISTV KOLENO



Koda	Dimenzije (mm)	Cena
<b>CCO16</b>	16	<b>6,22</b>
<b>CCO20</b>	20	<b>9,58</b>
<b>CCO25</b>	25	<b>14,52</b>
<b>CCO32</b>	32	<b>23,77</b>

## ISTV PREHODNI KOS notranji navoj



Koda	Dimenzije (mm)	Cena
<b>EHCO1612</b>	16 x 1/2"	<b>3,88</b>
<b>EHCO1634</b>	16 x 3/4"	<b>5,19</b>
<b>EHCO2012</b>	20 x 1/2"	<b>6,04</b>
<b>EHCO2034</b>	20 x 3/4"	<b>6,16</b>
<b>EHCO2534</b>	25 x 3/4"	<b>11,04</b>
<b>EHCO251</b>	25 x 1"	<b>12,81</b>
<b>EHCO3234</b>	32 x 3/4"	<b>12,64</b>
<b>EHCO321</b>	32 x 1"	<b>13,62</b>

## ISTV T-KOS reducirni



Koda	Dimenzije (mm)	Cena
<b>TRCO162016</b>	16 x 20 x 16	<b>11,59</b>
<b>TRCO201620</b>	20 x 16 x 20	<b>12,57</b>
<b>TRCO202016</b>	20 x 20 x 16	<b>12,57</b>
<b>TRCO251625</b>	25 x 16 x 25	<b>19,89</b>
<b>TRCO252020</b>	25 x 20 x 20	<b>20,50</b>
<b>TRCO252025</b>	25 x 20 x 25	<b>21,72</b>
<b>TRCO321632</b>	32 x 16 x 32	<b>24,25</b>
<b>TRCO322032</b>	32 x 20 x 32	<b>23,67</b>
<b>TRCO322532</b>	32 x 25 x 32	<b>26,77</b>

## ISTV T-KOS notranji navoj



Koda	Dimenzije (mm)	Cena
<b>THCO1612</b>	16 x 1/2"	<b>8,30</b>
<b>THCO2012</b>	20 x 1/2"	<b>11,59</b>
<b>THCO2034</b>	20 x 3/4"	<b>14,40</b>
<b>THCO2534</b>	25 x 3/4"	<b>20,13</b>
<b>THCO321</b>	32 x 1"	<b>25,80</b>

## ISTV PODOMETNI KROGELNI VENTIL



Koda	Dimenzije (mm)	Cena
<b>VALCO16</b>	16	<b>22,45</b>
<b>VALCO20</b>	20	<b>26,17</b>
<b>VALCO25</b>	25	<b>28,65</b>
<b>VALCO32</b>	32	<b>36,05</b>

## ISTV KAPA VENTILA Z ROZETO



Koda	Dimenzije (mm)	Cena
<b>MO</b>	16	<b>6,01</b>

## ISTV REDUCIRKA



Koda	Dimenzije (mm)	Cena
<b>RCO2016</b>	20-16	<b>7,69</b>
<b>RCO2520</b>	25-20	<b>11,96</b>
<b>RCO3225</b>	32-25	<b>17,26</b>

## ISTV KOLENO zunanji navoj



Koda	Dimenzije (mm)	Cena
<b>CMCO1612</b>	16 x 1/2"	<b>5,12</b>
<b>CMCO2012</b>	20 x 1/2"	<b>6,71</b>
<b>CMCO2534</b>	25 x 3/4"	<b>11,96</b>

## ISTV KOLENO notranji navoj



Koda	Dimenzije (mm)	Cena
<b>CHCO1612</b>	16 x 1/2"	<b>5,06</b>
<b>CHCO1634</b>	16 x 3/4"	<b>6,22</b>
<b>CHCO2012</b>	20 x 1/2"	<b>6,95</b>
<b>CHCO2034</b>	20 x 3/4"	<b>8,05</b>
<b>CHCO2534</b>	25 x 3/4"	<b>11,83</b>
<b>CHCO251</b>	25 x 1"	<b>12,81</b>
<b>CHCO321</b>	32 x 1"	<b>15,01</b>

## ISTV PREHODNI KOS zunanji navoj



Koda	Dimenzije (mm)	Cena
<b>EMCO1612</b>	16 x 1/2"	<b>3,84</b>
<b>EMCO1634</b>	16 x 3/4"	<b>4,72</b>
<b>EMCO2012</b>	20 x 1/2"	<b>5,80</b>
<b>EMCO2034</b>	20 x 3/4"	<b>5,73</b>
<b>EMCO2534</b>	25 x 3/4"	<b>9,27</b>
<b>EMCO251</b>	25 x 1"	<b>9,64</b>
<b>EMCO3234</b>	32 x 3/4"	<b>12,74</b>
<b>EMCO321</b>	32 x 1"	<b>14,87</b>

## ISTV PREHODNI KOS Cu na Alu



Koda	Dimenzije (mm)	Cena
<b>AD/C12-M16</b>	12 na 16 x 2	<b>1,84</b>
<b>AD/C15-M16</b>	15 na 16 x 2	<b>2,37</b>
<b>AD/C18-M16</b>	18 na 16 x 2	<b>2,62</b>
<b>AD/C15-M20</b>	15 na 20 x 2	<b>3,17</b>
<b>AD/C18-M20</b>	18 na 20 x 2	<b>3,57</b>
<b>AD/C22-M20</b>	22 na 20 x 2	<b>3,72</b>
<b>AD/C22-M25</b>	22 na 25 x 2,5	<b>4,72</b>
<b>AD/C28-M25</b>	28 na 25 x 2,5	<b>5,66</b>
<b>AD/C28-M32</b>	28 na 32 x 3	<b>6,27</b>

## ISTV T-KOS



Koda	Dimenzije (mm)	Cena
<b>TCO16</b>	16	<b>8,85</b>
<b>TCO20</b>	20	<b>13,91</b>
<b>TCO25</b>	25	<b>23,79</b>
<b>TCO32</b>	32	<b>27,16</b>

## ISTV KROGELNI VENTIL



Koda	Dimenzije (mm)	Cena
<b>VAL-LINCO16</b>	16	<b>18,54</b>
<b>VAL-LINCO20</b>	20	<b>22,94</b>
<b>VAL-LINCO25</b>	25	<b>32,21</b>
<b>VAL-LINCO32</b>	32	<b>32,23</b>

## ISTV ČEP VIJAČNI



Koda	Dimenzije (mm)	Cena
<b>TAP16-R</b>	16	<b>3,57</b>

## ALKATEN CEV PN16



Koda	Naziv	DN	PN	m/pak	Cena/m
2619	Alkaten cev	20	16 bar	200	<b>0,67</b>
2620	Alkaten cev	25	16 bar	200	<b>0,95</b>
2621	Alkaten cev	32	16 bar	200	<b>1,51</b>
2622	Alkaten cev	40	16 bar	200	<b>2,34</b>
2623	Alkaten cev	50	16 bar	200	<b>3,65</b>
2624	Alkaten cev	63	16 bar	200	<b>5,77</b>
2625	Alkaten cev	75	16 bar	100	<b>8,08</b>
2626	Alkaten cev	90	16 bar	100	<b>11,66</b>
2627	Alkaten cev	110	16 bar	100	<b>17,39</b>

## ALKATEN SPOJKA ENOJNA zunanji navoj



Koda	DN	Cena
3121	20-1/2"	<b>1,59</b>
3122	20-3/4"	<b>1,66</b>
3123	25-1/2"	<b>1,73</b>
3124	25-3/4"	<b>1,78</b>
3125	25-1"	<b>1,85</b>
3126	32-1/2"	<b>2,03</b>
3127	32-3/4"	<b>2,05</b>
3128	32-1"	<b>2,10</b>
3129	32-5/4"	<b>2,17</b>
3130	40-1"	<b>2,81</b>
3131	40-5/4"	<b>2,88</b>
3132	40-6/4"	<b>2,98</b>
31323V	50-5/4"	<b>7,61</b>
3133	50-6/4"	<b>7,71</b>
3197	50-2"	<b>7,78</b>
31972	63-6/4"	<b>9,20</b>
3134	63-2"	<b>9,27</b>
31342	75-2"	<b>14,52</b>
31343	75-2½"	<b>14,62</b>
31344	75-3"	<b>8,93</b>
31345	90-2"	<b>16,88</b>
31346	90-2½"	<b>30,72</b>
31347	90-3"	<b>34,53</b>
31961	110-2"	<b>30,91</b>
31962	110-3"	<b>63,03</b>
31963	110-4"	<b>31,11</b>

## ALKATEN SPOJKA DVOJNA



Koda	DN	Cena
3100	20-20	<b>2,61</b>
3101	25-25	<b>3,15</b>
3102	32-32	<b>3,95</b>
3103	40-40	<b>6,32</b>
3104	50-50	<b>9,88</b>
3105	63-63	<b>12,64</b>
3216	75-75	<b>26,84</b>
32161	90-90	<b>51,34</b>
32162	110-110	<b>94,75</b>

## ALKATEN SPOJKA REDUCIRNA



Koda	DN	Cena
3106	25-20	<b>2,76</b>
3107	32-20	<b>4,05</b>
3108V	32-25	<b>4,15</b>
3109	40-25	<b>4,39</b>
3110	40-32	<b>4,54</b>
3111	50-32	<b>15,20</b>
3112	50-40	<b>15,40</b>
3113	63-40	<b>16,59</b>
3114	63-50	<b>16,59</b>
31141	75-50	<b>19,37</b>
3209	90-63	<b>47,78</b>
32091	90-75	<b>42,99</b>
32092	110-90	<b>100,67</b>

## ALKATEN ČEP



Koda	DN	Cena
3172	20	<b>1,98</b>
3173	25	<b>2,37</b>
3174	32	<b>2,76</b>
3175	40	<b>4,34</b>
3176	50	<b>6,71</b>
3177	63	<b>9,08</b>
31771	75	<b>18,96</b>
31772	90	<b>37,50</b>
31773	110	<b>72,57</b>

## ALKATEN T- KOS



Koda	DN	Cena
3135	20-20-20	2,76
3136V	25-25-25	3,37
3137V	32-32-32	7,30
3138	40-40-40	7,91
3139	50-50-50	11,05
3140	63-63-63	20,91
31401	75-75-75	33,16
31402	90-90-90	86,86
31403	110-110-110	134,25

## ALKATEN T- KOS notranji navoj



Koda	DN	Cena
3162V	20-1/2"-20	2,85
3163	25-1/2"-25	3,25
3164	25-3/4"-25	3,27
3203V	32-1/2"-32	3,22
3204V	32-3/4"-32	3,25
3165	32-1"-32	5,29
3166	40-1"-40	6,08
3167	40-5/4"-40	6,08
3168	50-5/4"-50	13,03
3169	50-6/4"-50	13,03
3170	63-6/4"-63	23,69
3171	63-2"-63	23,69
31712	75-2½"-75	34,84

## ALKATEN T- KOS REDUCIRNI



Koda	DN	Cena
3141	25-20-25	5,12
3142	32-20-32	6,32
3143	32-25-32	6,32
3144	40-25-40	7,91
3145	40-32-40	7,93
3146	50-32-50	15,40
3147	50-40-50	15,40
3148	63-25-63	22,47
3149	63-32-63	22,50
3150	63-40-63	15,76
3151	63-50-63	23,69
31511	75-63-75	31,35
31513	90-75-90	75,76
31514	110-90-110	134,25

## ALKATEN T- KOS zunanji navoj



Koda	DN	Cena
3152V	20-1/2"-20	2,85
3153	25-1/2"-25	3,25
3154	25-3/4"-25	3,25
3201	32-1/2"-32	3,42
3202V	32-3/4"-32	4,15
3155	32-1"-32	5,29
3156	40-1"-40	6,08
3157	40-5/4"-40	6,08
3158	50-5/4"-50	13,79
3159	50-6/4"-50	13,03
3160	63-6/4"-63	15,79
3161	63-2"-63	15,79
31612	90-3"-90	77,45

## ALKATEN KOLENO ENOJNO notranji navoj



Koda	DN	Cena
3191V	20-1/2"	1,98
3192	25-3/4"	2,85
3193	32-1"	3,25
3194V	40-5/4"	4,15
3205V	50-6/4"	7,91
3195	63-2"	9,47

## ALKATEN KOLENO ENOJNO zunanji navoj



Koda	DN	Cena
3179V	20-1/2"	1,98
3180	20-3/4"	2,03
3181	25-1/2"	2,05
3182	25-3/4"	2,37
3183	32-1/2"	2,71
3184	32-3/4"	2,71
3185	32-1"	2,76
3186	40-1"	4,10
3187	40-5/4"	4,15
3188	40-6/4"	4,17
3189	50-5/4"	7,86
3206	50-6/4"	7,91
3207	50-2"	7,93
3208	63-6/4"	9,47
3190	63-2"	9,47
31904	90-3"	33,57

## ALKATEN KOLENO DVOJNO



Koda	DN	Cena
3115	20-20	2,61
3116	25-25	3,15
3117	32-32	3,66
3118	40-40	5,34
3119	50-50	9,08
3120	63-63	13,83
31201	75-75	24,08
31102	90-90	67,12
31103	110-110	90,82



**PP-R FIBERGLASS CEV (PN20) za vodovod-ogrevanje-komprimiran zrak**



Koda	DN	Temperatura (C°)		Enota	Cena
<b>2813</b>	20	zelena	90	m	<b>2,33</b>
<b>2814</b>	25	zelena	90	m	<b>3,69</b>
<b>2815</b>	32	zelena	90	m	<b>6,28</b>
<b>2816</b>	40	zelena	90	m	<b>9,31</b>
<b>2817</b>	50	zelena	90	m	<b>14,73</b>
<b>2818</b>	63	zelena	90	m	<b>23,28</b>

**PP-R PRITRDILNO KOLENO notranji navoj**

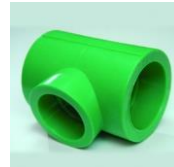

Koda	DN	Cena
<b>2863</b>	20-1/2"	<b>3,965</b>
<b>2864</b>	25-3/4"	<b>5,047</b>
<b>2917</b>	20-3/4"	<b>7,330</b>

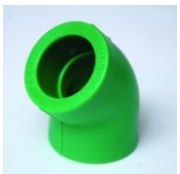
**PP-R T-KOS**

Koda	DN	Cena
<b>2831</b>	20	<b>0,476</b>
<b>2832</b>	25	<b>0,773</b>
<b>2833</b>	32	<b>1,932</b>
<b>2834</b>	40	<b>3,865</b>
<b>2835</b>	50	<b>5,946</b>
<b>2836</b>	63	<b>11,416</b>

**PP-R KOLENO 45°**

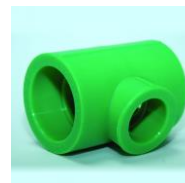
Koda	DN	Cena
<b>2819</b>	20-45	<b>0,386</b>
<b>2820</b>	25-45	<b>0,476</b>
<b>2821</b>	32-45	<b>1,219</b>
<b>2822</b>	40-45	<b>2,646</b>
<b>2823</b>	50-45	<b>3,835</b>
<b>2824</b>	63-45	<b>8,423</b>

**PP-R T-KOS reducirni**

Koda	DN	Cena
<b>2918</b>	25-20-25	<b>1,159</b>
<b>2919</b>	32-20-32	<b>1,932</b>
<b>2920</b>	32-25-32	<b>1,932</b>
<b>2933</b>	40-25-40	<b>5,241</b>
<b>2906</b>	40-32-40	<b>4,758</b>
<b>2907</b>	50-32-50	<b>8,654</b>
<b>2908</b>	50-40-50	<b>9,249</b>
<b>2912V</b>	63-25-63	<b>6,958</b>
<b>2909</b>	63-40-63	<b>13,804</b>
<b>2911</b>	63-50-63	<b>14,402</b>

**PP-R PREHODNO KOLENO notranji navoj**

Koda	DN	Cena
<b>2880</b>	20-1/2"	<b>3,965</b>
<b>2881</b>	25-3/4"	<b>5,377</b>
<b>2915</b>	32-1"	<b>11,235</b>

**PP-R T-KOS notranji navoj**

Koda	DN	Cena
<b>2857</b>	20 -1/2"-20	<b>4,626</b>
<b>2858</b>	25-3/4"-25	<b>5,678</b>
<b>2859</b>	32-1"-32	<b>11,025</b>

**PP-R KOLENO M/Ž**



Koda	DN	Cena
<b>2952</b>	20	<b>0,850</b>

**PP-R PRITRDILNO KOLENO zunanji navoj**

Koda	DN	Cena
<b>2865</b>	20-1/2"	<b>5,077</b>
<b>2866</b>	25-3/4"	<b>7,180</b>
<b>2912</b>	20-3/4"	<b>7,330</b>

**PP-R T-KOS zunanji navoj**

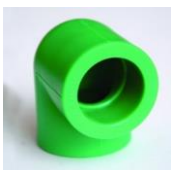
Koda	DN	Cena
<b>2860</b>	20 -1/2"-20	<b>5,347</b>
<b>2861</b>	25-3/4"-25	<b>7,811</b>
<b>2862</b>	32-1"-32	<b>17,093</b>

**PP-R KOLENO 90°**

Koda	DN	Cena
<b>2825</b>	20-90	<b>0,386</b>
<b>2826</b>	25-90	<b>0,535</b>
<b>2827</b>	32-90	<b>1,605</b>
<b>2828</b>	40-90	<b>3,300</b>
<b>2829</b>	50-90	<b>4,846</b>
<b>2830</b>	63-90	<b>8,413</b>

**PP-R T-PREHODNI KOS**

Koda	DN	Cena
<b>2873</b>	20	<b>4,626</b>
<b>2874</b>	25	<b>5,678</b>
<b>2875</b>	32	<b>11,025</b>

**PP-R PREHODNO KOLENO zunanji navoj**



Koda	DN	Cena
<b>2882</b>	20-1/2"	<b>5,137</b>
<b>2883</b>	25-3/4"	<b>7,060</b>
<b>2916V</b>	32-1"	<b>15,922</b>

**PP-R T-KOS Z IZPUSTOM**

Koda	DN	Cena
<b>2930</b>	20	<b>7,210</b>
<b>2931</b>	25	<b>8,178</b>

**PP-R HOLANDEC notranji navoj**

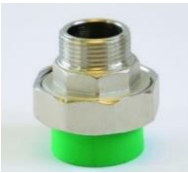
Koda	DN	Cena
<b>2901</b>	20-1/2"	<b>8,291</b>
<b>2900</b>	25-3/4"	<b>12,287</b>
<b>2902</b>	32-1"	<b>14,220</b>

**PP-R HOLANDEC zunanji navoj**

Koda	DN	Cena
<b>2903</b>	20-1/2"	<b>6,489</b>
<b>2904</b>	25-3/4"	<b>9,523</b>
<b>2905</b>	32-1"	<b>15,955</b>

**PP-R PREHODNI KOS notranji navoj**

Koda	DN	Cena
<b>2867</b>	20-1/2"	<b>4,206</b>
<b>2868</b>	25-3/4"	<b>4,777</b>
<b>2869</b>	32-1"	<b>9,373</b>
<b>2924</b>	40-5/4"	<b>34,668</b>
<b>2925</b>	50-6/4"	<b>57,139</b>
<b>2926</b>	63-2"	<b>65,460</b>

**PP-R PREHODNI KOS zunanji navoj**



Koda	DN	Cena
<b>2870</b>	20-1/2"	<b>4,626</b>
<b>2871</b>	25-3/4"	<b>8,321</b>
<b>2872</b>	32-1"	<b>14,900</b>
<b>2927</b>	40-5/4"	<b>51,521</b>
<b>2928</b>	50-6/4"	<b>64,378</b>
<b>2929</b>	63-2"	<b>76,876</b>

**PP-R VENTIL PODOMETNI zaporni**

Koda	DN	Cena
<b>2921</b>	20	<b>11,716</b>
<b>2922</b>	25	<b>14,390</b>
<b>2879</b>	32	<b>30,563</b>

**PP-R VENTIL PODOMETNI s kapo**

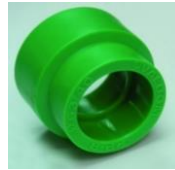
Koda	DN	Cena
<b>2877</b>	20	<b>11,891</b>
<b>2878</b>	25	<b>15,264</b>

**PP-R REDUCIRKA**

Koda	DN	Cena
<b>2843</b>	25-20	<b>0,327</b>
<b>2844</b>	32-20	<b>0,476</b>
<b>2845</b>	32-25	<b>0,476</b>
<b>2846</b>	40-20	<b>1,219</b>
<b>2847V</b>	40-25	<b>1,219</b>
<b>2848</b>	40-32	<b>1,219</b>
<b>2849</b>	50-20	<b>1,992</b>
<b>2850</b>	50-25	<b>1,992</b>
<b>2851</b>	50-32	<b>1,992</b>
<b>2852</b>	50-40	<b>1,843</b>
<b>2853</b>	63-25	<b>4,073</b>
<b>2854</b>	63-32	<b>4,073</b>
<b>2855</b>	63-40	<b>4,073</b>
<b>2856</b>	63-50	<b>4,106</b>

**PP-R SPOJKA**

Koda	DN	Cena
<b>2837</b>	20	<b>0,327</b>
<b>2838</b>	25	<b>0,386</b>
<b>2839</b>	32	<b>1,011</b>
<b>2840</b>	40	<b>1,932</b>
<b>2841</b>	50	<b>2,943</b>
<b>2842</b>	63	<b>5,856</b>

**PP-R IZOGIBNI LOK ekstrudirani**

Koda	DN	Cena
<b>2895</b>	20	<b>2,213</b>
<b>2894</b>	25	<b>3,468</b>

**PP-R IZOGIBNI LOK brizgani**

Koda	DN	Cena
<b>2892</b>	20	<b>1,784</b>
<b>2893</b>	25	<b>1,932</b>

**PP-R ZAKLJUČNI ČEP**

Koda	DN	Cena
<b>2884</b>	20	<b>0,297</b>
<b>2885</b>	25	<b>0,386</b>
<b>2886</b>	32	<b>0,713</b>
<b>2887</b>	40	<b>1,605</b>
<b>2888</b>	50	<b>2,408</b>
<b>2889</b>	63	<b>4,013</b>

**PVC ČEP modri/rdeči**

Koda	DN		Cena
<b>2913V</b>	1/2"	rdeči	<b>1,043</b>
<b>2686</b>	1/2"	modri	<b>0,759</b>
<b>2914V</b>	3/4"	rdeči	<b>1,565</b>
<b>2685</b>	3/4"	modri	<b>1,161</b>

## TROJNI HIŠNI FILTER EKO-TRIPLEX-MAGO-EKO-FOS, R<sup>3/4</sup>"



Koda		Cena
<b>83409</b>	R <sup>3/4</sup> "	<b>229,36</b>
	Max. obratovalni tlak 7bar. Max. temperatura vode 30°C. Višina 310mm.	
<b>82822</b>	Mehanski vl.z mrežico	
<b>88879</b>	Kombinirani vl.s kristali	
<b>82624</b>	Vložek aktivno oglje	

## TROJNI HIŠNI FILTER EKO-TRIS R<sup>3/4</sup>"



Koda		Cena
<b>86660</b>	EKO TRIS <sup>3/4</sup> "	<b>169,58</b>
	Max. obratovalni tlak 7bar. Max. temperatura vode 30°C. Višina 310mm.	
<b>80415</b>	Mehanski filt.vložek	
<b>88879</b>	Kombinirani vl.pleteni	
<b>82624</b>	Vložek aktivno oglje	

## DVOJNI HIŠNI FILTER ZA VODO EKO-DUPLEX R<sup>3/4</sup>"



Koda		Cena
<b>82549</b>	R <sup>3/4</sup> "	<b>152,13</b>
	Max. obratovalni tlak 7bar. Max. temperatura vode 30°C. Višina 310mm.	
<b>80415</b>	Vložek mehanski z mrežico	
<b>82617</b>	Vložek mehanski z inox mrežico	

## DVOJNI HIŠNI FILTER ZA DEŽEVNICO EKO-TWIN <sup>3/4</sup>"



Koda		Cena
<b>87797</b>	R <sup>3/4</sup> "	<b>78,32</b>
	Max. obratovalni tlak 7bar. Max. temperatura vode 30°C. Višina 310mm.	
<b>80514</b>	Mehanski vl. polypropylen	
<b>80903</b>	Vložek aktivno oglje	

## TROSMERNI MEHČALEC VODE EKOM<sup>1/2</sup>"



Koda		Cena
<b>89197</b>	R <sup>1/2</sup> "	<b>31,60</b>
	Max. obratovalni tlak 7bar. Max. temperatura vode 30°C. Višina 310mm.	
	Mehčalec za pitno vodo s kristali polyphosphat	

## TROJNI HIŠNI FILTER ZA DEŽEVNICO EKO-TRIPLE <sup>3/4</sup>"



Koda		Cena
<b>88671</b>	EKO TRIPLE <sup>3/4</sup> "	<b>114,68</b>
	Max. obratovalni tlak 7bar. Max. temperatura vode 30°C. Višina 310mm.	
<b>80415</b>	Mehanski filt.vložek z mrežico	
<b>80514</b>	Mehanski vl.polypropylen	
<b>80903</b>	Vložek aktivno oglje	

## FILTRI ZA TOPLOTNE ČRPALKE



Koda		Cena
<b>85267</b>	19,05 mm (R 3/4) višina 10"	<b>66,38</b>
<b>85274</b>	25,4 mm (R 1) višina 10"	<b>69,24</b>
<b>85281</b>	31,75 mm (R 5/4) višina 10"	<b>78,35</b>

<b>82426</b>	Mehanski filt. vložek z mrežico	
<b>85243</b>	Mehanski filt. vložek z mrežico	

## SAMOČISTILNI MEHANSKI FILTER ZA VODO R<sup>3/4</sup>"



Koda		Cena
<b>82129</b>	R <sup>3/4</sup> " (malo ohišje)	<b>81,74</b>
	Max. obratovalni tlak 7bar. Max. temperatura vode 30°C. Višina 310mm.	
<b>82822</b>	Mehanski filtrni vložek za samočistilni filter za vodo z mrežico, 60mcr, višina 10"	

## MAGO-EKO-FOS kombinirani mehanski filter <sup>3/4</sup>"



Koda		Cena
<b>88923</b>	R <sup>3/4</sup> " 10"	<b>169,58</b>
	Max. obratovalni tlak 7bar. Max. temperatura vode 30°C. Višina 310mm.	
	Z magnetnim nevtralizatorjem vodnega kamna	
<b>89395</b>	Deljeni mehanski vložek z mrežico	

## MEHČALEC ZA PRALNI STROJ <sup>3/4</sup>"



Koda		Cena
<b>80095</b>	R <sup>3/4</sup> " DOSAL	<b>15,40</b>

Mehčalec za pitno vodo s kristali polyphosphat. Vgradimo ga neposredno pred uporabniki vode kot so: pralni stroj, pomivalni stroj, likalnik. Menjava na 6 - 12 mesecev.

## ELEKTRIČNI MEHČALEC VODNEGA KAMNA AQUA 2000

















Koda	Naziv	Cena
<b>2000-B</b>	Električni mehčalec vodnega kamna Aqua 2000	<b>237,90</b>



Montaža na dovodne bakrene, pocinkane, inox in alkatene vodovodne cevi, pretok 50l/min, frekvenca pulznega delovanja med 7 in 14kHz, zanemarljiva poraba el.energije

## VLOŽKI ZA FILTRE

Koda	Naziv	Cena
	<b>82822</b> Mehanski filterni vložek za samočistilni filter za vodo z mrežico, višina 9¾" (60 µm)	<b>17,81</b>
	<b>88879</b> Kombinirani vložek filtra pleteni s s kristali, višina 10" (25µm)	<b>18,06</b>
	<b>82839</b> Ekstrudirani mehanski vložek EPP polypropilen višina 128mm, (5µm)	<b>7,23</b>
	<b>80903</b> Vložek filtra aktivno oglje (carbon block) - sintrano, višina 9¾" (10µm)	<b>16,84</b>
	<b>82624</b> Vložek filtra aktivno oglje (carbon block) - sintrano, višina 9¾" (5µm)	<b>17,81</b>
	<b>80415</b> Vložek filtra mehanski z mrežico, višina 9¾" (50µm)	<b>11,98</b>
	<b>80514</b> Vložek filtra polypropylen za ohišje R¾" in R1", višina 10" mehanski, pleteni	<b>4,82</b>
	<b>80415</b> Vložek filtra mehanski s polyester mrežico, višina 10" SX (50µm)	<b>11,98</b>
	<b>80330</b> Vložek filtra za mehčanje vode s polnilom polyphosphat, višina 9¾"	<b>20,11</b>
	<b>82143</b> Vložek filtra mehanski, višina 9¾" (5µm)	<b>8,14</b>
	<b>82280</b> Vložek filtra aktivno oglje, višina 128mm, (5µm)	<b>21,90</b>
	<b>80552</b> Vložek filtra aktivno oglje, višina 248mm, (0,3µm)	<b>39,04</b>
	<b>80101</b> Dozirno sredstvo za mehčanje vode -polyphosphat (pakirano 0,5kg)	<b>8,42</b>
	<b>85885</b> Tesnilo filtra 1/2"	<b>1,89</b>
	<b>89944</b> Tesnilo filtra 3/4"	<b>1,89</b>

## KANALIZACIJSKA CEV HTEM PRO - 1 grlo

Koda	EAN	Naziv	Cena
<b>C032PRO0150</b>	3831020520721	CEV HTEM PRO 32/150	<b>1,002</b>
<b>C032PRO0250</b>	3831020520738	CEV HTEM PRO 32/250	<b>1,549</b>
<b>C032PRO0500</b>	3831020520745	CEV HTEM PRO 32/500	<b>2,520</b>
<b>C032PRO1000</b>	3831020532410	CEV HTEM PRO 32/1000	<b>4,151</b>
<b>C032PRO1500</b>	3831020520752	CEV HTEM PRO 32/1500	<b>5,979</b>
<b>C032PRO2000</b>	3831020520769	CEV HTEM PRO 32/2000	<b>7,738</b>
<b>C032PRO3000</b>	3831020520776	CEV HTEM PRO 32/3000	<b>10,033</b>
<b>C040PRO0150</b>	3831020520851	CEV HTEM PRO 40/150	<b>1,455</b>
<b>C040PRO0250</b>	3831020520868	CEV HTEM PRO 40/250	<b>1,496</b>
<b>C040PRO0500</b>	3831020520875	CEV HTEM PRO 40/500	<b>2,308</b>
<b>C040PRO1000</b>	3831020532380	CEV HTEM PRO 40/1000	<b>4,136</b>
<b>C040PRO1500</b>	3831020520882	CEV HTEM PRO 40/1500	<b>5,863</b>
<b>C040PRO2000</b>	3831020520899	CEV HTEM PRO 40/2000	<b>7,302</b>
<b>C040PRO3000</b>	3831020520905	CEV HTEM PRO 40/3000	<b>10,451</b>
<b>C050PRO0150</b>	3831020520585	CEV HTEM PRO 50/150	<b>1,455</b>
<b>C050PRO0250</b>	3831020520592	CEV HTEM PRO 50/250	<b>2,036</b>
<b>C050PRO0500</b>	3831020520608	CEV HTEM PRO 50/500	<b>3,021</b>
<b>C050PRO1000</b>	3831020532427	CEV HTEM PRO 50/1000	<b>4,961</b>
<b>C050PRO1500</b>	3831020520615	CEV HTEM PRO 50/1500	<b>7,109</b>
<b>C050PRO2000</b>	3831020520622	CEV HTEM PRO 50/2000	<b>9,014</b>
<b>C050PRO3000</b>	3831020520639	CEV HTEM PRO 50/3000	<b>13,182</b>
<b>C075PRO0150</b>	3831020520998	CEV HTEM PRO 75/150	<b>2,196</b>
<b>C075PRO0250</b>	3831020521001	CEV HTEM PRO 75/250	<b>3,262</b>
<b>C075PRO0500</b>	3831020521018	CEV HTEM PRO 75/500	<b>4,490</b>
<b>C075PRO1000</b>	3831020532434	CEV HTEM PRO 75/1000	<b>7,170</b>
<b>C075PRO1500</b>	3831020521025	CEV HTEM PRO 75/1500	<b>11,390</b>
<b>C075PRO2000</b>	3831020521032	CEV HTEM PRO 75/2000	<b>12,454</b>
<b>C075PRO3000</b>	3831020521049	CEV HTEM PRO 75/3000	<b>19,789</b>
<b>C090PRO0150</b>	3831020521131	CEV HTEM PRO 90/150	<b>3,827</b>
<b>C090PRO0250</b>	3831020521148	CEV HTEM PRO 90/250	<b>4,669</b>
<b>C090PRO0500</b>	3831020521155	CEV HTEM PRO 90/500	<b>7,109</b>
<b>C090PRO1000</b>	3831020532397	CEV HTEM PRO 90/1000	<b>10,935</b>
<b>C090PRO1500</b>	3831020521162	CEV HTEM PRO 90/1500	<b>16,493</b>
<b>C090PRO2000</b>	3831020521179	CEV HTEM PRO 90/2000	<b>19,451</b>
<b>C090PRO3000</b>	3831020521186	CEV HTEM PRO 90/3000	<b>26,188</b>
<b>C110PRO0150</b>	3831020532502	CEV HTEM PRO 110/150	<b>3,827</b>
<b>C110PRO0250</b>	3831020532465	CEV HTEM PRO 110/250	<b>5,153</b>
<b>C110PRO0500</b>	3831020532519	CEV HTEM PRO 110/500	<b>7,820</b>
<b>C110PRO1000</b>	3831020532441	CEV HTEM PRO 110/1000	<b>11,985</b>
<b>C110PRO1500</b>	3831020532472	CEV HTEM PRO 110/1500	<b>18,157</b>
<b>C110PRO2000</b>	3831020532403	CEV HTEM PRO 110/2000	<b>21,420</b>
<b>C110PRO3000</b>	3831020532557	CEV HTEM PRO 110/3000	<b>32,729</b>
<b>C125PRO0150</b>	3831020532076	CEV HTEM PRO 125/150	<b>7,788</b>
<b>C125PRO0250</b>	3831020532038	CEV HTEM PRO 125/250	<b>8,271</b>
<b>C125PRO0500</b>	3831020532113	CEV HTEM PRO 125/500	<b>11,663</b>
<b>C125PRO1000</b>	3831020532120	CEV HTEM PRO 125/1000	<b>18,188</b>
<b>C125PRO1500</b>	3831020532137	CEV HTEM PRO 125/1500	<b>23,939</b>
<b>C125PRO2000</b>	3831020532090	CEV HTEM PRO 125/2000	<b>29,336</b>
<b>C125PRO3000</b>	3831020532144	CEV HTEM PRO 125/3000	<b>46,103</b>
<b>C160PRO0150</b>	3831020532175	CEV HTEM PRO 160/150	<b>10,451</b>
<b>C160PRO0250</b>	3831020532274	CEV HTEM PRO 160/250	<b>14,409</b>
<b>C160PRO0500</b>	3831020532281	CEV HTEM PRO 160/500	<b>19,078</b>
<b>C160PRO1000</b>	3831020532298	CEV HTEM PRO 160/1000	<b>29,952</b>
<b>C160PRO1500</b>	3831020532243	CEV HTEM PRO 160/1500	<b>43,310</b>
<b>C160PRO2000</b>	3831020532304	CEV HTEM PRO 160/2000	<b>50,046</b>
<b>C160PRO3000</b>	3831020532250	CEV HTEM PRO 160/3000	<b>73,468</b>





## KOLENO HTB

Koda	EAN	Naziv	Cena
<b>K032000015ARGO</b>	3831020500341	KOLENO HTB 32/15°	<b>1,000</b>
<b>K032000030ARGO</b>	3831020500358	KOLENO HTB 32/30°	<b>1,000</b>
<b>K032000045</b>	3831020500716	KOLENO HTB 32/45°	<b>1,000</b>
<b>K032000067</b>	3831020500365	KOLENO HTB 32/67°	<b>1,000</b>
<b>K032000087</b>	3831020500723	KOLENO HTB 32/87°	<b>1,000</b>
<b>K040000015</b>	3831020500761	KOLENO HTB 40/15°	<b>1,000</b>
<b>K040000030</b>	3831020500778	KOLENO HTB 40/30°	<b>1,000</b>
<b>K040000045</b>	3831020500785	KOLENO HTB 40/45°	<b>1,000</b>
<b>K040000067</b>	3831020500792	KOLENO HTB 40/67°	<b>1,000</b>
<b>K040000087</b>	3831020500808	KOLENO HTB 40/87°	<b>1,000</b>
<b>K050000015</b>	3831020500815	KOLENO HTB 50/15°	<b>1,169</b>
<b>K050000030</b>	3831020500822	KOLENO HTB 50/30°	<b>1,169</b>
<b>K050000045</b>	3831020500839	KOLENO HTB 50/45°	<b>1,169</b>
<b>K050000067</b>	3831020500846	KOLENO HTB 50/67°	<b>1,169</b>
<b>K050000087</b>	3831020500853	KOLENO HTB 50/87°	<b>1,169</b>
<b>K075000015</b>	3831020500372	KOLENO HTB 75/15°	<b>3,159</b>
<b>K075000030</b>	3831020500389	KOLENO HTB 75/30°	<b>3,159</b>
<b>K075000045</b>	3831020500860	KOLENO HTB 75/45°	<b>2,281</b>
<b>K075000067</b>	3831020500396	KOLENO HTB 75/67°	<b>3,159</b>
<b>K075000087</b>	3831020500877	KOLENO HTB 75/87°	<b>2,281</b>
<b>K090000015</b>	3831020526068	KOLENO HTB 90/15°	<b>4,996</b>
<b>K090000030</b>	3831020526075	KOLENO HTB 90/30°	<b>4,996</b>
<b>K090000045</b>	3831020526082	KOLENO HTB 90/45°	<b>4,996</b>
<b>K090000067</b>	3831020526099	KOLENO HTB 90/67°	<b>4,996</b>
<b>K090000087</b>	3831020526105	KOLENO HTB 90/87°	<b>4,996</b>
<b>K110000015</b>	3831020500914	KOLENO HTB 110/15°	<b>3,865</b>
<b>K110000030</b>	3831020500921	KOLENO HTB 110/30°	<b>3,865</b>
<b>K110000045</b>	3831020500938	KOLENO HTB 110/45°	<b>3,865</b>
<b>K110000067</b>	3831020500945	KOLENO HTB 110/67°	<b>3,865</b>
<b>K110000087</b>	3831020500952	KOLENO HTB 110/87°	<b>3,865</b>
<b>K125000015</b>	3831020500983	KOLENO HTB 125/15°	<b>15,037</b>
<b>K125000030</b>	3831020500990	KOLENO HTB 125/30°	<b>15,037</b>
<b>K125000045</b>	3831020500969	KOLENO HTB 125/45°	<b>7,183</b>
<b>K125000067</b>	3831020501058	KOLENO HTB 125/67°	<b>16,301</b>
<b>K125000087</b>	3831020500976	KOLENO HTB 125/87°	<b>7,183</b>
<b>K160000015</b>	3831020501034	KOLENO HTB 160/15°	<b>22,088</b>
<b>K160000030</b>	3831020501041	KOLENO HTB 160/30°	<b>22,088</b>
<b>K160000045</b>	3831020501010	KOLENO HTB 160/45°	<b>11,540</b>
<b>K160000087</b>	3831020501027	KOLENO HTB 160/87°	<b>11,540</b>

## WC KOLENA

Koda	EAN	Naziv	Cena
<b>W110000090SID</b>	3831020527201	WC KOLENO 110/90 ODCEP 50 DESNO	<b>19,835</b>
<b>W110000090SIDV</b>	3831020524552	WC KOLENO Z DVEMA GRLOMA IN TESNILOM/sivc	<b>33,914</b>
<b>W110000090SIL</b>	3831020501607	WC KOLENO 110/90 ODCEP 50 LEVO	<b>19,835</b>
<b>W110000090SIZ</b>	3831020501614	WC KOLENO 110/90 ODCEP 50 ZADAJ	<b>19,835</b>
<b>W11045050-D</b>	3831020531277	WC KOLENO 110/45 ODCEP 50 DESNO	<b>19,836</b>
<b>W11045050DV</b>	3831020531307	WC KOLENO 110/45° ODCEP 50 DVOJNI	<b>33,913</b>
<b>W11045050-L</b>	3831020531288	WC KOLENO 110/45/ODCEP 50 LEVO	<b>19,836</b>
<b>W11045050-Z</b>	3831020531291	WC KOLENO 110/45 ODCEP 50 ZADAJ	<b>19,836</b>

## PVC KOLENO DVOJNO plastbrno

Koda	EAN	Naziv	Cena
<b>CKT5000</b>	8595156216280	PVC koleno dvojno 50	<b>5,270</b>

## SIFONSKO KOLENO HTSW



Koda	EAN	Naziv	Cena
<b>IL-K03200004600S</b>	3831020524385	SIFONSKO KOLENO HTSW 32/46	<b>5,861</b>
<b>IL-K04000004600S</b>	3831020526945	SIFONSKO KOLENO HTSW 40/46	<b>2,956</b>
<b>IL-K0400000460DS</b>	3831020524422	SIFONSKO KOLENO HTSWL DOLGO 40/46	<b>3,901</b>
<b>IL-K04000005000S</b>	3831020524392	SIFONSKO KOLENO HTSW 40/50	<b>3,320</b>
<b>IL-K0400000500DS</b>	3831020524415	SIFONSKO KOLENO HTSWL DOLGO 40/50	<b>3,901</b>
<b>IL-K05000005000S</b>	3831020524408	SIFONSKO KOLENO HTSW 50/50	<b>3,886</b>
<b>K03200004600S</b>	3831020524385	SIFONSKO KOLENO HTSW 32/46	<b>5,861</b>
<b>K04000004600S</b>	3831020526945	SIFONSKO KOLENO HTSW 40/46	<b>2,956</b>
<b>K0400000460DS</b>	3831020524422	SIFONSKO KOLENO HTSWL DOLGO 40/46	<b>3,901</b>
<b>K04000005000S</b>	3831020524392	SIFONSKO KOLENO HTSW 40/50	<b>3,320</b>
<b>K0400000500DS</b>	3831020524415	SIFONSKO KOLENO HTSWL DOLGO 40/50	<b>3,901</b>
<b>K05000005000S</b>	3831020524408	SIFONSKO KOLENO HTSW 50/50	<b>3,886</b>

## ODCEP ENOJNI REDUCIRANI HTEA

Koda	EAN	Naziv	Cena
<b>O0500000450040</b>	3831020501324	ODCEP HTEA 50/40/45°	<b>3,317</b>
<b>O0500000670040</b>	3831020519848	ODCEP HTEA 50/40/67°	<b>5,946</b>
<b>O0500000870040</b>	3831020501331	ODCEP HTEA 50/40/87°	<b>3,715</b>
<b>O0750000450050</b>	3831020501348	ODCEP HTEA 75/50/45°	<b>3,508</b>
<b>O0750000670050</b>	3831020508729	ODCEP HTEA 75/50/67°	<b>5,684</b>
<b>O0750000870050</b>	3831020501355	ODCEP HTEA 75/50/87°	<b>3,508</b>
<b>O0900000450040</b>	3831020526303	ODCEP HTEA 90/40/45°	<b>7,448</b>
<b>O0900000450050</b>	3831020526310	ODCEP HTEA 90/50/45°	<b>6,464</b>
<b>O0900000450075</b>	3831020526327	ODCEP HTEA 90/75/45°	<b>5,883</b>
<b>O0900000870040</b>	3831020511484	ODCEP HTEA 90/40/87,5°	<b>7,448</b>
<b>O0900000870050</b>	3831020526341	ODCEP HTEA 90/50/87°	<b>6,464</b>
<b>O0900000870075</b>	3831020526358	ODCEP HTEA 90/75/87°	<b>5,882</b>
<b>O1100000450040</b>	3831020500471	ODCEP HTEA 110/40/45°	<b>9,095</b>
<b>O1100000450050</b>	3831020501379	ODCEP HTEA 110/50/45°	<b>4,488</b>
<b>O1100000450075</b>	3831020501409	ODCEP HTEA 110/75/45°	<b>6,072</b>
<b>O1100000450090</b>	3831020523715	ODCEP HTEA 110/90/45°	<b>28,047</b>
<b>O1100000670050AR</b>	3831020500440	ODCEP HTEA 110/50/67,5°	<b>4,468</b>
<b>O1100000670075</b>	3831020508736	ODCEP HTEA 110/75/67°	<b>7,826</b>
<b>O1100000870040</b>	3831020500464	ODCEP HTEA 110/40/87°	<b>4,375</b>
<b>O1100000870050</b>	3831020501386	ODCEP HTEA 110/50/87°	<b>4,450</b>
<b>O1100000870075</b>	3831020501416	ODCEP HTEA 110/75/87°	<b>6,072</b>
<b>O1100000870090</b>	3831020523722	ODCEP HTEA 110/90/87°	<b>28,049</b>
<b>O1250000450011</b>	3831020501430	ODCEP HTEA 125/110/45°	<b>13,954</b>
<b>O1250000450050</b>	3831020519213	ODCEP HTEA 125/50/45°	<b>26,316</b>
<b>O1250000450075</b>	3831020519220	ODCEP HTEA 125/75/45°	<b>27,465</b>
<b>O1250000870011</b>	3831020501447	ODCEP HTEA 125/110/87°	<b>13,954</b>
<b>O1250000870050</b>	3831020531314	ODCEP HTEA 125/50/87°	<b>26,316</b>
<b>O1250000870075</b>	3831020519237	ODCEP HTEA 125/75/87°	<b>27,465</b>
<b>O125V000450050</b>	3831020519213	ODCEP HTEA 125/50/45°	<b>26,316</b>
<b>O125V000870050</b>	3831020531314	ODCEP HTEA 125/50/87°	<b>26,316</b>
<b>O1600000450011</b>	3831020501461	ODCEP HTEA 160/110/45°	<b>19,891</b>
<b>O1600000450012</b>	3831020501485	ODCEP HTEA 160/125/45°	<b>22,116</b>
<b>O1600000450050</b>	3831020528505	ODCEP HTEA 160/50/45°	<b>30,004</b>
<b>O1600000450075</b>	3831020531413	ODCEP HTEA 160/75/45°	<b>30,225</b>
<b>O1600000870011</b>	3831020501478	ODCEP HTEA 160/110/87°	<b>19,891</b>
<b>O1600000870012</b>	3831020501492	ODCEP HTEA 160/125/87°	<b>22,116</b>
<b>O1600000870050</b>	3831020531406	ODCEP HTEA 160/50/87°	<b>30,004</b>
<b>O032000045</b>	3831020501119	ODCEP HTEA 32/32/45°	<b>2,187</b>
<b>O032000087</b>	3831020501126	ODCEP HTEA 32/32/87°	<b>2,207</b>
<b>O040000045</b>	3831020501140	ODCEP HTEA 40/40/45°	<b>2,055</b>
<b>O040000067ARGO</b>	3831020500426	ODCEP HTEA 40/40/67,5°	<b>2,150</b>
<b>O040000087</b>	3831020501157	ODCEP HTEA 40/40/87°	<b>2,055</b>

## ODCEP ENOJNI REDUCIRANI HTEA

Koda	EAN	Naziv	Cena
<b>O050000045</b>	3831020501171	ODCEP HTEA 50/50/45°	<b>2,263</b>
<b>O050000067ARGO</b>	3831020500433	ODCEP HTEA 50/50/67,5°	<b>2,394</b>
<b>O050000087</b>	3831020501188	ODCEP HTEA 50/50/87°	<b>2,263</b>
<b>O075000045</b>	3831020501201	ODCEP HTEA 75/75/45°	<b>3,658</b>
<b>O075000067</b>	3831020520103	ODCEP HTEA 75/75/67°	<b>6,464</b>
<b>O075000087</b>	3831020501218	ODCEP HTEA 75/75/87°	<b>3,658</b>
<b>O090000045</b>	3831020526297	ODCEP HTEA 90/90/45°	<b>6,955</b>
<b>O090000087</b>	3831020526334	ODCEP HTEA 90/90/87°	<b>8,183</b>
<b>O110000045</b>	3831020501232	ODCEP HTEA 110/110/45°	<b>6,618</b>
<b>O11000006700AR</b>	3831020500457	ODCEP HTEA 110/110/67,5°	<b>7,166</b>
<b>O110000087</b>	3831020501249	ODCEP HTEA 110/110/87°	<b>6,618</b>
<b>O125000045</b>	3831020501263	ODCEP HTEA 125/125/45°	<b>13,954</b>
<b>O125000087</b>	3831020501270	ODCEP HTEA 125/125/87°	<b>13,954</b>
<b>O160000045</b>	3831020501294	ODCEP HTEA 160/160/45°	<b>23,305</b>
<b>O160000087</b>	3831020501300	ODCEP HTEA 160/160/87°	<b>23,305</b>



## PVC ODCEP ENOJNI GIBLJIVI 45°-87° plastbrno

Koda	EAN	Naziv	Cena
<b>COK0556</b>	8595156240667	PVC ODCEP ENOJNI GIBLJIVI-50/50 ; 45°-87°	<b>7,879</b>
<b>COK0A56</b>	8595156240674	PVC ODCEP ENOJNI GIBLJIVI-110/50 ; 45°-87°	<b>10,198</b>

## ODCEP DVOJNI HTDA

Koda	EAN	Naziv	Cena
<b>O05000004500D</b>	3831020506701	ODCEP HTDA 50/50/50/45°	<b>16,765</b>
<b>O05000006700D</b>	3831020526266	ODCEP HTDA 50/50/50/67°	<b>11,407</b>
<b>O05000008700D</b>	3831020506718	ODCEP HTDA 50/50/50/87°	<b>16,765</b>
<b>O07500004500D</b>	3831020506749	ODCEP HTDA 75/75/75/45°	<b>20,473</b>
<b>O07500004500DR50</b>	3831020505902	ODCEP HTDA 75/50/50/45°	<b>37,137</b>
<b>O07500008700D</b>	3831020506756	ODCEP HTDA 75/75/75/87°	<b>20,473</b>
<b>O07500008700DR50</b>	3831020505919	ODCEP HTDA 75/50/50/87°	<b>37,137</b>
<b>O0900000087D</b>	3831020526280	ODCEP HTDA 90/90/90/87°	<b>22,437</b>
<b>O09000004500D05</b>	3831020518476	ODCEP HTDA 90/50/50/45°	<b>19,006</b>
<b>O11000000670050D</b>	3831020526952	ODCEP HTDA 110/50/50/67°	<b>19,214</b>
<b>O1100000067D</b>	3831020526365	ODCEP HTDA 110/110/110/67°	<b>37,408</b>
<b>O11000004500075</b>	3831020518407	ODCEP HTDA 110/75/75/45°	<b>40,361</b>
<b>O11000004500D</b>	3831020504202	ODCEP HTDA 110/110/110/45°	<b>22,682</b>
<b>O11000004500DR50</b>	3831020506794	ODCEP HTDA 110/50/50/45°	<b>19,214</b>
<b>O11000006700DD</b>	3831020500587	ODCEP KOTNI HTED 110/110/110/67°	<b>40,015</b>
<b>O110000067DV</b>	3831020526372	ODCEP HTDA 110/110/110/67°	<b>37,408</b>
<b>O11000008700D50</b>	3831020506855	ODCEP HTDA 110/50/50/87°	<b>19,214</b>
<b>O110ARGO8700D</b>	3831020518339	ODCEP HTDA 110/110/110/87° ARGO	<b>22,682</b>
<b>O12500004500D</b>	3831020518414	ODCEP HTDA 125/125/125/45°	<b>90,643</b>
<b>O12500008700D</b>	3831020518421	ODCEP HTDA 125/125/125/87°	<b>90,643</b>
<b>O12500008700D11</b>	3831020505926	ODCEP HTDA 125/110/110/87°	<b>89,031</b>
<b>O16000004500D</b>	3831020518452	ODCEP HTDA 160/160/160/45°	<b>112,518</b>
<b>O16000004500DR11</b>	3831020526518	ODCEP HTDA 160/110/110/45°	<b>104,458</b>
<b>O16000008700D</b>	3831020520172	ODCEP HTDA 160/160/160/87°	<b>32,205</b>



## PVC ODCEP DVOJNI GIBLJIVI 45°-87° plastbrno

Koda	EAN	Naziv	Cena
<b>COKA556</b>	8595156240681	PVC ODCEP DVOJNI GIBLJIVI DN110/50/50 ; 45°-87°	<b>14,151</b>

## WC PRIKLJUČEK S TESNILOM

Koda	EAN	Naziv	Cena
<b>W11000000000P</b>	3856015901699	WC PRIKLJUČEK S TESNILOM HTSK 110/130	<b>25,123</b>







## ČISTILNI KOS HTRE

Koda	EAN	Naziv	Cena
<b>CC0500000000K</b>	3831020502062	ČISTILNI KOS HTRE 50	<b>3,771</b>
<b>CC0750000000K</b>	3831020502079	ČISTILNI KOS HTRE 75	<b>4,996</b>
<b>CC0900000000K</b>	3831020525627	ČISTILNI KOS HTRE 90	<b>12,090</b>
<b>CC1100000000K</b>	3831020502086	ČISTILNI KOS HTRE 110	<b>6,957</b>
<b>CC1250000000K</b>	3831020502093	ČISTILNI KOS HTRE 125	<b>17,610</b>
<b>CC1600000000K</b>	3831020502109	ČISTILNI KOS HTRE 160	<b>24,643</b>



## PVC PREHOD NA LITINO plastbrno

Koda	EAN	Naziv	Cena
<b>CL50001</b>	8595156224056	PVC PREHOD NA LITINO DN50 - 72/121	<b>1,839</b>
<b>CL70001</b>	8595156224063	PVC PREHOD NA LITINO DN75 - 97/127	<b>1,921</b>
<b>CLA0001</b>	8595156224094	PVC PREHOD NA LITINO DN110 - 124/141	<b>2,741</b>



## PVC REDUCIRKA NIZKA GIBLJIVA 3°- 40° plastbrno

Koda	EAN	Naziv	Cena
<b>COKRA56</b>	8595156242418	PVC REDUCIRKA NIZKA GIBLJIVA 110/50, 3°- 40°	<b>7,879</b>



## PVC GRLENA SPOJKA M/Ž plastbrno

Koda	EAN	Naziv	Cena
<b>CRPAA00</b>	8595156227118	PVC HTSM GRLENA SPOJKA M/Ž-110/110	<b>5,300</b>
<b>CRP5500</b>	8595156273566	PVC HTSM GRLENA SPOJKA GLOBOKA 50/50 M/Ž	<b>4,099</b>



Koda	EAN	Naziv	Cena
<b>CRPCA00</b>	8595156228306	PVC HTSM GRLENA SPOJKA M/Ž-125/110	<b>5,534</b>
<b>CRPGA00</b>	8595156229556	PVC HTSM GRLENA SPOJKA M/Ž-160/110	<b>22,136</b>



Koda	EAN	Naziv	Cena
<b>CRPAA01</b>	8595156240735	PVC KGSM GRLENA SPOJKA M/Ž-110/110	<b>6,787</b>
<b>CRPCA01</b>	8595156240742	PVC KGSM GRLENA SPOJKA M/Ž-125/110	<b>10,845</b>



## DRSNA SPOJKA HTU

Koda	EAN	Naziv	Cena
<b>D032</b>	3831020502123	DRSNA SPOJKA HTU 32	<b>1,564</b>
<b>D040</b>	3831020502130	DRSNA SPOJKA HTU 40	<b>1,564</b>
<b>D050</b>	3831020502147	DRSNA SPOJKA HTU 50	<b>1,640</b>
<b>D075</b>	3831020502154	DRSNA SPOJKA HTU 75	<b>2,545</b>
<b>D090</b>	3831020523241	DRSNA SPOJKA HTU 90	<b>4,710</b>
<b>D110</b>	3831020502161	DRSNA SPOJKA HTU 110	<b>3,865</b>
<b>D125</b>	3831020502178	DRSNA SPOJKA HTU 125	<b>8,523</b>
<b>D160</b>	3831020502192	DRSNA SPOJKA HTU 160	<b>12,934</b>



## SPOJKA Z DVOJNIM GRLOM

Koda	EAN	Naziv	Cena
<b>D032ABOX0000DG</b>	3831020523074	SPOJKA HTMM 32 Z DVOJNIM GRLOM ARGON	<b>1,564</b>
<b>D040ABOX0000DG</b>	3831020523319	SPOJKA HTMM 40 Z DVOJNIM GRLOM ARGON	<b>1,564</b>
<b>D050ABOX0000DG</b>	3831020523142	SPOJKA HTMM 50 Z DVOJNIM GRLOM ARGON	<b>1,640</b>
<b>D075ABOX0000DG</b>	3831020523159	SPOJKA HTMM 75 Z DVOJNIM GRLOM ARGON	<b>2,545</b>
<b>D110ABOX0000DG</b>	3831020523135	SPOJKA HTMM 110 Z DVOJNIM GRLOM ARGON	<b>3,869</b>
<b>D125ABOX0000DG</b>	3831020515499	SPOJKA HTMM 125 Z DVOJNIM GRLOM ARGON	<b>8,522</b>
<b>D160ABOX0000DG</b>	3831020515505	SPOJKA HTMM 160 Z DVOJNIM GRLOM ARGON	<b>12,935</b>



## SPOJKE S TROJNO GLOBINO GRLA HTLL

Koda	EAN	Naziv	Cena
<b>S040</b>	3831020500266	SPOJKA 3X GLOBINA GRLA HTLL 40	<b>5,892</b>
<b>S050</b>	3831020500273	SPOJKA 3X GLOBINA GRLA HTLL 50	<b>6,271</b>
<b>S075</b>	3831020500280	SPOJKA 3X GLOBINA GRLA HTLL 75	<b>10,030</b>
<b>S090</b>	3831020527027	SPOJKA 3X GLOBINA GRLA HTLL 90	<b>7,499</b>
<b>S110</b>	3831020500297	SPOJKA 3X GLOBINA GRLA HTLL 110	<b>13,620</b>
<b>S125L</b>	3831020520537	SPOJKA 3X GLOBINA GRLA HTLL 125	<b>17,670</b>
<b>S160L</b>	3831020522985	SPOJKA 3X GLOBINA GRLA HTLL 160	<b>26,583</b>

## PREHODNI KOS HTR

Koda	EAN	Naziv	Cena
<b>P040000000032</b>	3831020501898	R-KOS HTR 40/32	<b>1,320</b>
<b>P040000000032K</b>	3831020500563	R-KOS HTR-KRATKA 40/32	<b>1,321</b>
<b>P040000000032R</b>	3831020508941	R-KOS HTRR 40/32	<b>2,829</b>
<b>P0400000000050</b>	3831020508958	R-KOS HTRR 40/50	<b>3,653</b>
<b>P0500000000032</b>	3831020501904	R-KOS HTR 50/32	<b>1,320</b>
<b>P0500000000040</b>	3831020501911	R-KOS HTR 50/40	<b>1,320</b>
<b>P0500000000040K</b>	3831020500570	R-KOS HTR-KRATKA 50/40	<b>1,321</b>
<b>P0750000000050</b>	3831020501928	R-KOS HTR 75/50	<b>1,848</b>
<b>P075000000040K</b>	3831020520544	R-KOS HTR-KRATKA 75/40	<b>4,601</b>
<b>P075000000050K</b>	3831020526617	R-KOS HTR-KRATKA 75/50	<b>4,600</b>
<b>P0900000000040</b>	3831020500334	R-KOS HTR-KRATKA 90/40	<b>2,921</b>
<b>P0900000000050</b>	3831020526648	R-KOS HTR-KRATKA 90/50	<b>2,920</b>
<b>P0900000000075</b>	3831020527232	R-KOS HTR-KRATKA 90/75	<b>4,311</b>
<b>P10000000000110</b>	3831020501065	PREHODNI KOS PVC/PP 100/110	<b>7,221</b>
<b>P11000000000050</b>	3831020501942	R-KOS HTR 110/50	<b>2,620</b>
<b>P1100000000050V</b>	3831020508927	R-KOS HTR-KRATKA 110/50	<b>3,811</b>
<b>P1100000000075</b>	3831020501959	R-KOS HTR 110/75	<b>2,620</b>
<b>P1100000000075V</b>	3831020522237	R-KOS HTR-KRATKA 110/75	<b>3,754</b>
<b>P1100000000090</b>	3831020526655	R-KOS HTR-KRATKA 110/90	<b>4,352</b>
<b>P1100000000090R</b>	3831020512030	R-KOS HTRR 110/90	<b>24,503</b>
<b>P11010000000R</b>	8023857138230	R-KOS HTR 110/100 R	<b>10,156</b>
<b>P12500000000050</b>	3831020522343	R-KOS HTR 125/50	<b>13,670</b>
<b>P12500000000075T</b>	3831020511309	R-KOS HTR 125/75	<b>10,306</b>
<b>P12500000000110</b>	3831020501980	R-KOS HTR 125/110	<b>3,940</b>
<b>P12500000000110K</b>	3831020505216	R-KOS HTR-KRATKA 125/110	<b>7,682</b>
<b>P16000000000110</b>	3831020502017	R-KOS HTR 160/110	<b>5,864</b>
<b>P16000000000125</b>	3831020502024	R-KOS HTR 160/125	<b>6,316</b>
<b>P16000000110K</b>	8023857034815	R-KOS HTR-KRATKA 160/110	<b>19,065</b>

## ČEP HTM

Koda	EAN	Naziv	Cena
<b>CC032</b>	3831020502482	ČEP HTM 32	<b>0,679</b>
<b>CC040</b>	3831020502253	ČEP HTM 40	<b>0,679</b>
<b>CC050</b>	3831020502260	ČEP HTM 50	<b>0,679</b>
<b>CC075</b>	3831020502277	ČEP HTM 75	<b>1,038</b>
<b>CC090</b>	3831020525610	ČEP HTM 90	<b>3,204</b>
<b>CC110</b>	3831020502284	ČEP HTM 110	<b>1,245</b>
<b>CC125</b>	3831020502291	ČEP HTM 125	<b>1,772</b>
<b>CC160</b>	3831020502307	ČEP HTM 160	<b>2,602</b>

## PVC PROTISMRAJNA KAPA PB plastbrno

Koda	EAN	Naziv	Cena
<b>AVP4000</b>	8595156222397	PVC PROTISMRAJNA KAPA 40	<b>6,852</b>
<b>AVP5000</b>	8595156222403	PVC PROTISMRAJNA KAPA 50	<b>6,588</b>
<b>AVP7000</b>	8595156222427	PVC PROTISMRAJNA KAPA 75	<b>8,520</b>
<b>AVPA000</b>	8595156222380	PVC PROTISMRAJNA KAPA 110	<b>26,059</b>



## ODZRAČEVALNA KAPA PP

Koda	EAN	Naziv	Cena
<b>O05000000000K</b>	3831020502215	ODZRAČEVALNA KAPA KADH 50 KRATKA	<b>14,462</b>
<b>O05000000000KD</b>	3831020509009	ODZRAČEVALNA KAPA KADH 50 DOLGA	<b>14,462</b>
<b>O07500000000K</b>	3831020502222	ODZRAČEVALNA KAPA KADH 75 KRATKA	<b>14,462</b>
<b>O07500000000KD</b>	3831020509016	ODZRAČEVALNA KAPA KADH 75 DOLGA	<b>14,462</b>
<b>O11000000000K</b>	3831020502239	ODZRAČEVALNA KAPA KADH 110 KRATKA	<b>20,137</b>
<b>O11000000000KD</b>	3831020509023	ODZRAČEVALNA KAPA KADH 110 DOLGA	<b>20,137</b>
<b>O12500000000ARGO</b>	3831020508989	ODZRAČEVALNA KAPA KADH 125 ARGO	<b>34,898</b>
<b>O16000000000ARGO</b>	3831020508996	ODZRAČEVALNA KAPA KADH 160 ARGO	<b>43,092</b>



## PVC ČEP S PRIKLJUČKOM za gumi cev - koleno plastbrno

Koda	EAN	Naziv	Cena
<b>UZ30R00</b>	8595156262522	PVC ČEP S PRIKLJUČKOM 30-kolenski 19-21mm	<b>5,124</b>
<b>UZ40R00</b>	8595156243194	PVC ČEP S PRIKLJUČKOM 40-kolenski 19-21mm	<b>5,124</b>
<b>UZ50R00</b>	8595156242449	PVC ČEP S PRIKLJUČKOM 50-kolenski 19-21mm	<b>5,124</b>

## PVC ČEP S PRIKLJUČKOM za gumi cev - ravni plastbrno

Koda	EAN	Naziv	Cena
<b>UZ30000</b>	8595156242944	PVC ČEP S PRIKLJUČKOM 30-ravni 8-25mm	<b>5,124</b>
<b>UZ40000</b>	8595156243187	PVC ČEP S PRIKLJUČKOM 40-ravni 8-25mm	<b>5,124</b>
<b>UZ50000</b>	8595156242432	PVC ČEP S PRIKLJUČKOM 50-ravni 8-25mm	<b>5,124</b>



## PVC REDUCIRKA S PRIKLJUČKOM za gumi cev - ravna plastbrno

Koda	EAN	Naziv	Cena
<b>UZH0002</b>	8595156203020	PVC reducirka s priključkom za gumi cev ravna	<b>26,088</b>

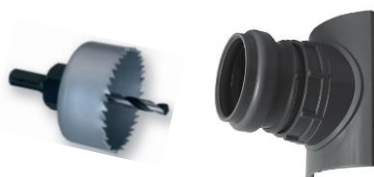

## PVC NAVRTALNI OKLEP plastbrno

Koda	EAN	Naziv	Cena
<b>COS0A48</b>	8595156228450	PVC NAVRTALNI OKLEP-110/40	<b>20,806</b>
<b>COS0A58</b>	8595156227132	PVC NAVRTALNI OKLEP-110/50	<b>20,806</b>
<b>COS0C58</b>	8595156242166	PVC NAVRTALNI OKLEP-125/50	<b>20,806</b>
<b>COS0000</b>	8595156227125	Navrtalna krona 110/50	<b>17,129</b>

## TESNILA

Koda	EAN	Naziv	Cena
<b>L032</b>	3831020502314	TESNILO LABIRINT BL 32	<b>0,191</b>
<b>L040</b>	3831020502352	TESNILO LABIRINT BL 40	<b>0,191</b>
<b>L050</b>	3831020502369	TESNILO LABIRINT BL 50	<b>0,191</b>
<b>L075</b>	3831020502376	TESNILO LABIRINT BL 75	<b>0,266</b>
<b>L090</b>	3831020527829	TESNILO LABIRINT BL 90	<b>0,412</b>
<b>L110</b>	3831020502383	TESNILO LABIRINT BL 110	<b>0,412</b>
<b>L125</b>	3831020502390	TESNILO LABIRINT BL 125	<b>0,751</b>
<b>L160</b>	3831020502406	TESNILO LABIRINT BL 160	<b>0,913</b>
<b>T046T000000000</b>	3831020529984	TESNILO SIFONSKO DL 46/40 T	<b>1,888</b>
<b>T047T000000000</b>	3831020529991	TESNILO SIFONSKO DL 47/32 T	<b>1,888</b>
<b>T050T000000032</b>	3831020530010	TESNILO SIFONSKO DL 50/32 T	<b>2,689</b>
<b>T050T000000040</b>	3831020530003	TESNILO SIFONSKO DL 50/40 T	<b>2,689</b>
<b>W03</b>	3831020502734	TESNILO WC ART.03 110	<b>17,631</b>
<b>W04</b>	3831020502741	TESNILO WC ART.04 110	<b>17,631</b>
<b>W11000000000U</b>	3831020502727	TESNILO WC UNIVERZAL 110	<b>17,631</b>



## MAST

Koda	EAN	Naziv	Cena
<b>M2000</b>	3831020517950	MAST MGN 2000g	<b>20,256</b>
<b>M250</b>	3831020502796	MAST MGN 250 g	<b>8,799</b>

## KANALIZACIJSKA CEV US PP nizkošumna

Koda	EAN	Naziv	Cena
<b>C032US0150</b>	7290107762540	USEM silent cev 1 32 L-150	<b>0,898</b>
<b>C032US0250</b>	7290107760959	USEM silent cev 1 32 L-250	<b>1,143</b>
<b>C032US0500</b>	7290107760966	USEM silent cev 1 32 L-500	<b>1,758</b>
<b>C032US1000</b>	7290107760973	USEM silent cev 1 32 L-1000	<b>2,987</b>
<b>C032US1500</b>	7290107760980	USEM silent cev 1 32 L-1500	<b>4,217</b>
<b>C032US2000</b>	7290107760997	USEM silent cev 1 32 L-2000	<b>5,444</b>
<b>C032US3000</b>	7290107761000	USEM silent cev 1 32 L-3000	<b>7,902</b>
<b>C040US0150</b>	7290107761062	USEM silent cev 1 40 L-150	<b>1,028</b>
<b>C040US0250</b>	7290107761079	USEM silent cev 1 40 L-250	<b>1,338</b>
<b>C040US0500</b>	7290107761086	USEM silent cev 1 40 L-500	<b>2,114</b>
<b>C040US1000</b>	7290107761093	USEM silent cev 1 40 L-1000	<b>3,668</b>
<b>C040US1500</b>	7290107761109	USEM silent cev 1 40 L-1500	<b>5,220</b>
<b>C040US2000</b>	7290107761116	USEM silent cev 1 40 L-2000	<b>6,773</b>
<b>C040US3000</b>	7290107761123	USEM silent cev 1 40 L-3000	<b>9,879</b>
<b>C050US0150</b>	7290107760089	USEM silent cev 1 50 L-150	<b>1,229</b>
<b>C050US0250</b>	7290107760096	USEM silent cev 1 50 L-250	<b>1,621</b>
<b>C050US0500</b>	7290107760102	USEM silent cev 1 50 L-500	<b>2,599</b>
<b>C050US1000</b>	7290107760119	USEM silent cev 1 50 L-1000	<b>4,558</b>
<b>C050US1500</b>	7290107760126	USEM silent cev 1 50 L-1500	<b>6,516</b>
<b>C050US2000</b>	7290107760133	USEM silent cev 1 50 L-2000	<b>8,475</b>
<b>C050US3000</b>	7290107762281	USEM silent cev 1 50 L-3000	<b>12,390</b>
<b>C075US0150</b>	7290107760140	USEM silent cev 1 75 L-150	<b>2,051</b>
<b>C075US0250</b>	7290107760157	USEM silent cev 1 75 L-250	<b>2,834</b>
<b>C075US0500</b>	7290107760164	USEM silent cev 1 75 L-500	<b>4,793</b>
<b>C075US1000</b>	7290107760171	USEM silent cev 1 75 L-1000	<b>8,709</b>
<b>C075US1500</b>	7290107760188	USEM silent cev 1 75 L-1500	<b>12,625</b>
<b>C075US2000</b>	7290107760195	USEM silent cev 1 75 L-2000	<b>16,541</b>
<b>C075US3000</b>	7290107760201	USEM silent cev 1 75 L-3000	<b>24,373</b>
<b>C090US0150</b>	7290107762274	USEM silent cev 1 90 L-150	<b>3,142</b>
<b>C090US0250</b>	7290107761284	USEM silent cev 1 90 L-250	<b>4,311</b>
<b>C090US0500</b>	7290107761291	USEM silent cev 1 90 L-500	<b>7,235</b>
<b>C090US1000</b>	7290107761307	USEM silent cev 1 90 L-1000	<b>13,082</b>
<b>C090US1500</b>	7290107761314	USEM silent cev 1 90 L-1500	<b>18,930</b>
<b>C090US2000</b>	7290107761321	USEM silent cev 1 90 L-2000	<b>24,777</b>
<b>C090US3000</b>	7290107761338	USEM silent cev 1 90 L-3000	<b>36,472</b>
<b>C110US0150</b>	7290107760010	USEM silent cev 1 110 L-150	<b>4,820</b>
<b>C110US0250</b>	7290107760027	USEM silent cev 1 110 L-250	<b>6,673</b>
<b>C110US0500</b>	7290107760034	USEM silent cev 1 110 L-500	<b>11,299</b>
<b>C110US1000</b>	7290107760041	USEM silent cev 1 110 L-1000	<b>20,550</b>
<b>C110US1500</b>	7290107760058	USEM silent cev 1 110 L-1500	<b>29,801</b>
<b>C110US2000</b>	7290107760065	USEM silent cev 1 110 L-2000	<b>39,051</b>
<b>C110US3000</b>	7290107760072	USEM silent cev 1 110 L-3000	<b>57,554</b>
<b>C125US0150</b>	7290107762472	USEM silent cev 1 125 L-150	<b>5,911</b>
<b>C125US0250</b>	7290107760799	USEM silent cev 1 125 L-250	<b>8,233</b>
<b>C125US0500</b>	7290107760805	USEM silent cev 1 125 L-500	<b>14,040</b>
<b>C125US1000</b>	7290107760812	USEM silent cev 1 125 L-1000	<b>25,654</b>
<b>C125US1500</b>	7290107760829	USEM silent cev 1 125 L-1500	<b>37,269</b>
<b>C125US2000</b>	7290107760836	USEM silent cev 1 125 L-2000	<b>48,881</b>
<b>C125US3000</b>	7290107760843	USEM silent cev 1 125 L-3000	<b>72,109</b>
<b>C160US0150</b>	7290107762403	USEM silent cev 1 160 L-150	<b>9,579</b>
<b>C160US0250</b>	7290107762434	USEM silent cev 1 160 L-250	<b>13,334</b>
<b>C160US0500</b>	7290107760904	USEM silent cev 1 160 L-500	<b>22,720</b>
<b>C160US1000</b>	7290107760911	USEM silent cev 1 160 L-1000	<b>41,490</b>
<b>C160US1500</b>	7290107760928	USEM silent cev 1 160 L-1500	<b>60,261</b>
<b>C160US2000</b>	7290107760935	USEM silent cev 1 160 L-2000	<b>79,031</b>
<b>C160US3000</b>	7290107760942	USEM silent cev 1 160 L-3000	<b>116,574</b>
<b>C200USH1000</b>	7290107763387	USEM silent cev 1 200 L-1000	<b>97,183</b>
<b>C200USH3000</b>	7290107763370	USEM silent cev 1 200 L-3000	<b>273,095</b>





## KOLENO USB nizkošumno

Koda	EAN	Naziv	Cena
<b>K032US15</b>	7290107761567	USB koleno 32/15°	<b>2,462</b>
<b>K032US30</b>	7290107761574	USB koleno 32/30°	<b>2,462</b>
<b>K032US45</b>	7290107761581	USB koleno 32/45°	<b>2,462</b>
<b>K032US67</b>	7290107761598	USB koleno 32/67°	<b>2,671</b>
<b>K032US87</b>	7290107761604	USB koleno 32/87°	<b>2,671</b>
<b>K040US15</b>	7290107761611	USB koleno 40/15°	<b>2,462</b>
<b>K040US30</b>	7290107761628	USB koleno 40/30°	<b>2,462</b>
<b>K040US45</b>	7290107761635	USB koleno 40/45°	<b>2,462</b>
<b>K040US67</b>	7290107761642	USB koleno 40/67°	<b>2,671</b>
<b>K040US87</b>	7290107761659	USB koleno 40/87°	<b>2,671</b>
<b>K050US15</b>	7290107760218	USB koleno 50/15°	<b>2,671</b>
<b>K050US30</b>	7290107760225	USB koleno 50/30°	<b>2,671</b>
<b>K050US45</b>	7290107760232	USB koleno 50/45°	<b>2,671</b>
<b>K050US67</b>	7290107761666	USB koleno 50/67°	<b>2,671</b>
<b>K050US87</b>	7290107760249	USB koleno 50/87°	<b>2,671</b>
<b>K075US15</b>	7290107760256	USB koleno 75/15°	<b>4,079</b>
<b>K075US30</b>	7290107760263	USB koleno 75/30°	<b>4,079</b>
<b>K075US45</b>	7290107760270	USB koleno 75/45°	<b>4,079</b>
<b>K075US67</b>	7290107760287	USB koleno 75/67°	<b>4,495</b>
<b>K075US87</b>	7290107760294	USB koleno 75/87°	<b>4,495</b>
<b>K090US15</b>	7290107761765	USB koleno 90/15°	<b>5,741</b>
<b>K090US30</b>	7290107761772	USB koleno 90/30°	<b>5,741</b>
<b>K090US45</b>	7290107761789	USB koleno 90/45°	<b>5,741</b>
<b>K090US67</b>	7290107761796	USB koleno 90/67°	<b>6,514</b>
<b>K090US87</b>	7290107761802	USB koleno 90/87°	<b>6,514</b>
<b>K110US15</b>	7290107760300	USB koleno 110/15°	<b>6,259</b>
<b>K110US30</b>	7290107760317	USB koleno 110/30°	<b>6,259</b>
<b>K110US45</b>	7290107760324	USB koleno 110/45°	<b>6,259</b>
<b>K110US67</b>	7290107760331	USB koleno 110/67°	<b>7,104</b>
<b>K110US87</b>	7290107760348	USB koleno 110/87°	<b>7,104</b>
<b>K125US15</b>	7290107761673	USB koleno 125/15°	<b>11,662</b>
<b>K125US30</b>	7290107761680	USB koleno 125/30°	<b>11,662</b>
<b>K125US45</b>	7290107761697	USB koleno 125/45°	<b>11,662</b>
<b>K125US67</b>	7290107761703	USB koleno 125/67°	<b>16,084</b>
<b>K125US87</b>	7290107761710	USB koleno 125/87°	<b>16,084</b>
<b>K160US16</b>	7290107761727	USB koleno 160/15°	<b>19,122</b>
<b>K160US31</b>	7290107761734	USB koleno 160/30°	<b>19,122</b>
<b>K160US46</b>	7290107761741	USB koleno 160/45°	<b>19,122</b>
<b>K160US87</b>	7290107761758	USB koleno 160/87°	<b>32,902</b>
<b>K200US45</b>	7290107762304	USB koleno 200/45°	<b>33,107</b>

## SIFONSKO KOLENO USSW nizkošumno

Koda	EAN	Naziv	Cena
<b>IL-K032US0460HU</b>	7290107762175	USSW sifonsko koleno 32/46	<b>7,166</b>
<b>IL-K040US0460HU</b>	7290107762182	USSW sifonsko koleno 40/46	<b>6,113</b>
<b>IL-K040US0500HU</b>	7290107762205	USSW sifonsko koleno 40/50	<b>6,113</b>
<b>IL-K050US0500HU</b>	7290107762229	USSW sifonsko koleno 50/50	<b>6,113</b>
<b>IL-KD040US0460HU</b>	7290107762199	USSWL sifonsko koleno dolgo 40/46	<b>7,722</b>
<b>IL-KD040US0500HU</b>	7290107762212	USSWL sifonsko koleno dolgo 40/50	<b>7,722</b>
<b>K032US0460HU</b>	7290107762175	USSW sifonsko koleno 32/46	<b>7,166</b>
<b>K040US0460HU</b>	7290107762182	USSW sifonsko koleno 40/46	<b>6,113</b>
<b>K040US0500HU</b>	7290107762205	USSW sifonsko koleno 40/50	<b>6,113</b>
<b>K050US0500HU</b>	7290107762229	USSW sifonsko koleno 50/50	<b>6,113</b>
<b>KD040US0460HU</b>	7290107762199	USSWL sifonsko koleno dolgo 40/46	<b>7,722</b>
<b>KD040US0500HU</b>	7290107762212	USSWL sifonsko koleno dolgo 40/50	<b>7,722</b>
<b>W090USLONG</b>	7290107762830	USSBL WC koleno dolgo 90	<b>6,091</b>
<b>W110USLONG</b>	7290107762762	USSBL WC koleno dolgo 110	<b>6,266</b>

## ČISTILNI KOS USRE nizkošumni

Koda	EAN	Naziv	Cena
<b>CC050US0000K</b>	7290107762236	USRE čistilni kos 50	<b>8,440</b>
<b>CC075US0000K</b>	7290107760720	USRE čistilni kos 75	<b>11,368</b>
<b>CC090US0000K</b>	7290107762250	USRE čistilni kos 90	<b>14,087</b>
<b>CC110US0000K</b>	7290107760737	USRE čistilni kos 110	<b>15,312</b>
<b>CC125US0000K</b>	7290107762892	USRE čistilni kos 125	<b>40,423</b>
<b>CC160US0000K</b>	7290107762847	USRE čistilni kos 160	<b>65,879</b>
<b>CC200US0000K</b>	7290107763363	USRE čistilni kos 200	<b>187,145</b>



## ODCEP USEA nizkošumni

Koda	EAN	Naziv	Cena
<b>O032US0045</b>	7290107761819	USEA odcep 32/32/45°	<b>4,777</b>
<b>O032US0087</b>	7290107762885	USEA odcep 32/32/87°	<b>4,880</b>
<b>O040US0045</b>	7290107761826	USEA odcep 40/40/45°	<b>5,133</b>
<b>O040US0087</b>	7290107761833	USEA odcep 40/40/87°	<b>5,133</b>
<b>O050US0045</b>	7290107760355	USEA odcep 50/50/45°	<b>6,113</b>
<b>O050US0087</b>	7290107760362	USEA odcep 50/50/87°	<b>6,113</b>
<b>O050US450040</b>	7290107761840	USEA odcep 50/40/45°	<b>6,113</b>
<b>O050US870040</b>	7290107761857	USEA odcep 50/40/87°	<b>6,113</b>
<b>O075US0045</b>	7290107760393	USEA odcep 75/75/45°	<b>6,749</b>
<b>O075US0087</b>	7290107760409	USEA odcep 75/75/87°	<b>6,749</b>
<b>O075US450050</b>	7290107760379	USEA odcep 75/50/45°	<b>6,749</b>
<b>O075US870050</b>	7290107760386	USEA odcep 75/50/87°	<b>6,749</b>
<b>O090US0045</b>	7290107761895	USEA odcep 90/90/45°	<b>12,674</b>
<b>O090US450040</b>	7290107762984	USEA odcep 90/40/45°	<b>12,663</b>
<b>O090US450050</b>	7290107761871	USEA odcep 90/50/45°	<b>12,674</b>
<b>O090US870050</b>	7290107761888	USEA odcep 90/50/87°	<b>12,597</b>
<b>O110US0045</b>	7290107760447	USEA odcep 110/110/45°	<b>13,843</b>
<b>O110US450040</b>	7290107762960	USEA odcep 110/40/45°	<b>13,828</b>
<b>O110US450050</b>	7290107760416	USEA odcep 110/50/45°	<b>13,843</b>
<b>O110US450075</b>	7290107760430	USEA odcep 110/75/45°	<b>13,843</b>
<b>O110US450090</b>	7290107762977	USEA odcep 110/90/45°	<b>13,828</b>
<b>O110US870050</b>	7290107760423	USEA odcep 110/50/87°	<b>13,843</b>
<b>O125US0045</b>	7290107760478	USEA odcep 125/125/45°	<b>53,482</b>
<b>O125US0087</b>	7290107761864	USEA odcep 125/125/87°	<b>39,118</b>
<b>O125US450110</b>	7290107760454	USEA odcep 125/110/45°	<b>31,714</b>
<b>O160US0045</b>	7290107760508	USEA odcep 160/160/45°	<b>101,073</b>
<b>O160US0087</b>	729010776051	USEA odcep 160/160/87°	<b>81,876</b>
<b>O160US450110</b>	7290107760485	USEA odcep 160/110/45°	<b>57,291</b>
<b>O200US450160</b>	7290107762489	USEA odcep 200/160/45°	<b>236,219</b>
<b>O200US450200</b>	7290107762496	USEA odcep 200/200/45°	<b>307,085</b>

## ODCEP DVOJNI USEA nizkošumni

Koda	EAN	Naziv	Cena
<b>O110US6700D</b>	7290107760744	USDA odcep dvojni 110/110/110/67°	<b>27,984</b>
<b>O110US6750D</b>	7290107760546	USDA odcep dvojni 110/50/50/67°	<b>24,806</b>
<b>O110US8700D</b>	7290107763417	USDA odcep dvojni 110/110/110/87°	<b>26,646</b>
<b>O110US8750D</b>	7290107767620	USDA odcep dvojni 110/50/50/87°	<b>52,825</b>

## ODCEP KOTNI USED nizkošumni

Koda	EAN	Naziv	Cena
<b>O110US8700DD</b>	7290107761925	USED odcep kotni 110/110/110/87°	<b>51,122</b>
<b>O125US8700DD</b>	7290107761932	USED odcep kotni 125/110/110/87°	<b>59,887</b>

## ODCEP US nizkošumni

Koda	EAN	Naziv	Cena
<b>O090US0087S</b>	7290107761918	US odcep swept 90/90/87°	<b>14,496</b>
<b>O110US0087S</b>	7290107760539	US odcep swept 110/110/87°	<b>14,496</b>
<b>O110US870075S</b>	7290107760522	US odcep swept 110/75/87°	<b>14,496</b>
<b>O110US870090S</b>	7290107761901	US odcep swept 110/90/87°	<b>14,496</b>
<b>O125US8700110S</b>	7290107760461	US odcep swept 125/110/87°	<b>31,715</b>
<b>O160US8700110S</b>	7290107760492	US odcep swept 160/110/87°	<b>50,959</b>

## SIFONSKI PRIKLJUČEK USS nizkošumni

Koda	EAN	Naziv	Cena
<b>IL-P032US00046</b>	7290107762854	USS priključek sifonski 32/46	<b>0,348</b>
<b>IL-P040US00046</b>	7290107762861	USS priključek sifonski 40/46	<b>0,523</b>
<b>IL-P040US00050</b>	7290107762878	USS priključek sifonski 40/50	<b>0,160</b>
<b>P032US00046</b>	7290107762854	USS priključek sifonski 32/46	<b>0,348</b>
<b>P040US00046</b>	7290107762861	USS priključek sifonski 40/46	<b>0,523</b>
<b>P040US00050</b>	7290107762878	USS priključek sifonski 40/50	<b>0,160</b>

## PREHODNI KOS USR nizkošumni

Koda	EAN	Naziv	Cena
<b>P040US000032</b>	7290107762052	USR prehodni kos 32/40	<b>3,651</b>
<b>P050US000032</b>	7290107760652	USR prehodni kos 32/50	<b>3,651</b>
<b>P050US000040</b>	7290107760669	USR prehodni kos 40/50	<b>3,651</b>
<b>P075US000050</b>	7290107760676	USR prehodni kos 50/75	<b>3,945</b>
<b>P090US000040</b>	7290107762090	USR prehodni kos 40/90	<b>3,945</b>
<b>P090US000050</b>	7290107762106	USR prehodni kos 50/90	<b>5,844</b>
<b>P090US000075</b>	7290107762953	USR prehodni kos 75/90	<b>5,843</b>
<b>P110US000040</b>	7290107762946	USR prehodni kos 40/110	<b>5,838</b>
<b>P110US000050</b>	7290107760683	USR prehodni kos 50/110	<b>5,843</b>
<b>P110US000075</b>	7290107760690	USR prehodni kos 75/110	<b>5,843</b>
<b>P110US000090</b>	7290107762069	USR prehodni kos 90/110	<b>11,122</b>
<b>P125US0000110</b>	7290107762076	USR prehodni kos 110/125	<b>11,122</b>
<b>P160US0000110</b>	7290107760706	USR prehodni kos 110/160	<b>16,795</b>
<b>P160US0000125</b>	7290107762083	USR prehodni kos 125/160	<b>16,795</b>
<b>P200US0000160</b>	7290107762571	USR prehodni kos 160/200	<b>122,933</b>



## DRSNA SPOJKA USU nizkošumna

Koda	EAN	Naziv	Cena
<b>D032US</b>	7290107763684	USU drsna spojka 32	<b>3,100</b>
<b>D040US</b>	7290107761994	USU drsna spojka 40	<b>3,307</b>
<b>D050US</b>	7290107760577	USU drsna spojka 50	<b>3,651</b>
<b>D075US</b>	7290107760591	USU drsna spojka 75	<b>4,643</b>
<b>D090US</b>	7290107762038	USU drsna spojka 90	<b>8,249</b>
<b>D110US</b>	7290107760614	USU drsna spojka 110	<b>8,084</b>
<b>D125US</b>	7290107762014	USU drsna spojka 125	<b>15,177</b>
<b>D160US</b>	7290107760638	USU drsna spojka 160	<b>22,368</b>
<b>D200US</b>	7290107762557	USU drsna spojka 200	<b>94,772</b>



## DRSNA SPOJKA USMM nizkošumna

Koda	EAN	Naziv	Cena
<b>D032US0000DG</b>	7290107761987	USMM drsna spojka dvojna 32	<b>3,100</b>
<b>D040US0000DG</b>	7290107762007	USMM drsna spojka dvojna 40	<b>3,307</b>
<b>D050US0000DG</b>	7290107760584	USMM drsna spojka dvojna 50	<b>3,651</b>
<b>D075US0000DG</b>	7290107760607	USMM drsna spojka dvojna 75	<b>4,643</b>
<b>D090US0000DG</b>	7290107762045	USMM drsna spojka dvojna 90	<b>8,249</b>
<b>D110USN000DG</b>	7290107763660	USMM drsna spojka dvojna 110 n	<b>8,084</b>
<b>D125US0000DG</b>	7290107762021	USMM drsna spojka dvojna 125	<b>15,177</b>
<b>D160US0000DG</b>	7290107760645	USMM drsna spojka dvojna 160	<b>22,368</b>
<b>D200US0000DG</b>	7290107763561	USMM drsna spojka dvojna 200	<b>94,772</b>



## SPOJKA PODALJŠANA USLL nizkošumna

Koda	EAN	Naziv	Cena
<b>S040US</b>	7290107762113	USLL spojka podaljšana 40	<b>3,651</b>
<b>S050US</b>	7290107762120	USLL spojka podaljšana 50	<b>4,777</b>
<b>S075US</b>	7290107762137	USLL spojka podaljšana 75	<b>6,749</b>
<b>S090US</b>	7290107762168	USLL spojka podaljšana 90	<b>9,681</b>
<b>S110US</b>	7290107760713	USLL spojka podaljšana 110	<b>10,890</b>
<b>S125US</b>	7290107762144	USLL spojka podaljšana 125	<b>14,768</b>
<b>S160US</b>	7290107762151	USLL spojka podaljšana 160	<b>25,024</b>



## ČEP USM nizkošumni

Koda	EAN	Naziv	Cena
<b>CC040US</b>	7290107761949	USM čep 40	<b>2,108</b>
<b>CC050US</b>	7290107762267	USM čep 50	<b>2,952</b>
<b>CC075US</b>	7290107760553	USM čep 75	<b>3,651</b>
<b>CC090US</b>	7290107761970	USM čep 90	<b>7,541</b>
<b>CC110US</b>	7290107760560	USM čep 110	<b>7,938</b>
<b>CC125US</b>	7290107761956	USM čep 125	<b>10,179</b>
<b>CC160US</b>	7290107761963	USM čep 160	<b>12,667</b>
<b>CC200US</b>	7290107766579	USM čep 200	<b>24,304</b>



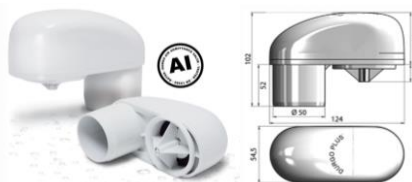

## PREZRAČEVALNI VENTIL DN50 za notranjo vgradnjo

Koda	EAN	Naziv	Cena
<b>7000.055</b>	7392948310536	DURGO Podometni prezračevalni ventil DN50	<b>84,90</b>

\*Po naročilu

Prezračevalni ventil za kanalizacijske cevi preprečuje širjenje smrada iz odtočnega sifona. V primeru podtlaka se odpre in omogoči dotok zraka v cev. Vgradi se na vrhu vertikale za odpadno vodo npr. na podstrehi, v votli steni, v spuščnem stropu ali pod umivalnikom. Mikroporna membrana je popolnoma tesna in zapre pot vsem vonjavam. Pretok: 19 l/s dovoda zraka pri podtlaku 2,5 mbar. Testirano in odobreno v skladu z EN 12380. Primerno za do 4 kopalnice. Zasnovan za namestitvev pod 5 cm širine.

**10 let garancije na vse izdelke !**



## PREZRAČEVALNI VENTIL DN110 za notranjo vgradnjo

Koda	EAN	Naziv	Cena
<b>7000.050</b>	7392948310505	DURGO Prezračevalni ventil DN50	<b>76,92</b>
<b>7000.110</b>	7392948311106	DURGO Prezračevalni ventil DN110	<b>108,95</b>

DN	z zunanjim navojem	z izolacijo		Razred	l/s*	Uporaba
		D(mm)	H(mm)			
DN50		54	48	/	/	sifon
DN50		84	98	120	120	do 4 kopalnice
DN110		140	120	180	147	6 do 12 kopalnic

A1	Možna je namestitev pod nivojem povratnega toka. Temperaturno območje -20°C do +60°C.
A2	Montaža možna samo nad nivojem povratnega toka. Temperaturno območje -20°C do +60°C.
l/s*	Izmerjena prostornina dotoka zraka po DIN EN 12380 v litrih /s pri -2,5 milibara (-250 Pa) podtlaka v sistemu. Največja vrednost dotoka zraka prezračevalnega ventila ustreza 95 % priključenega dimenzioniranja.

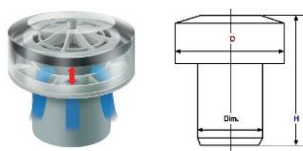

## PREZRAČEVALNI VENTIL DN15 na sifonskem kolenu / cevi - notranji navoj

Koda	EAN	Naziv	Cena
<b>7300.015</b>	4260387822206	DURGO Sifonsko koleno DN32-250-90°, odduh 1/2"	<b>67,10</b>

<b>7310.015</b>	4260387822305	DURGO Sifonska cev DN32-250, odduh 1/2"	<b>62,22</b>
-----------------	---------------	---	--------------



## PODOMETNE OMARICE za prezračevalni ventil

Koda	EAN	Naziv	Cena
<b>7900.000</b>	4260387829977	DURGO Podometna omarica PREMIUM brez pokrova, prezračevalni ventil DN50	<b>132,98</b>

Koda	EAN	Naziv	Cena
<b>7900.055</b>	4260387829991	DURGO Podometna omarica PREMIUM bela s pokrovom, prezračevalni ventil DN50	<b>211,06</b>



Vgradnja v steno z držali  
Magnetni na omarici

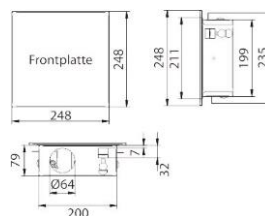

Koda	EAN	Naziv	Cena
<b>7550.000</b>	4260387825559	DURGO Podometna omarica BASIC s prezračevalnim ventilom DN50	<b>169,58</b>



Pokrov absorbira zvok.

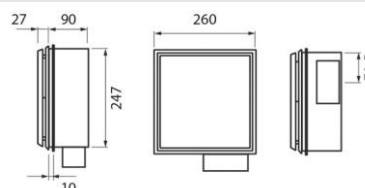

Koda	EAN	Naziv	Cena
<b>7900.400</b>	4260387829939	DURGO Vrataca z zapahom bela za PREMIUM	<b>114,12</b>



<b>7900.700</b>	4260387829960	DURGO Pokrov za vgradnjo ploščic, okvir inox mat, odduh PREMIUM	<b>177,84</b>
-----------------	---------------	---	---------------



\*Odprodaja

## WC MANŠETE

Koda	EAN	Naziv	Pakiranje	Cena
<b>MCP0000*</b>	8595156243101	Manšeta wc PVC gumi ravna	1	<b>4,319</b>
<b>MEP2000*</b>	8595156243118	Manšeta wc PVC gumi ekscenter	1	<b>4,477</b>
<b>MCS0000*</b>	8595156222526	Manšeta wc PVC ravna 110 bela	1	<b>2,574</b>
<b>MES0000*</b>	8595156223776	Manšeta wc PVC ekscenter 110 bela	1	<b>2,574</b>

## WC PRIKLJUČNE CEVI

Koda	EAN	Naziv	Pakiranje	Cena
<b>IL25000</b>	8595156222663	Wc priključek gibljivi 250-450mm	15	<b>10,365</b>
<b>IL32000</b>	8595156222687	Wc priključek gibljivi 320-540mm	15	<b>14,083</b>
<b>KR00000</b>	8595156224049	WC rozeta 110mm PVC	20	<b>1,874</b>

## PRIKLJUČNE PVC CEVI

Koda	EAN	Naziv	Pakiranje	Cena
<b>EV20000</b>	8595156209336	Koleno 45° DN 40/50	1	<b>2,167</b>

<b>GSP5400</b>	8595156226296	Gibljava cev 5/4" max.dolžina 850mm, DN 32/40	50	<b>2,281</b>
----------------	---------------	--	----	--------------

<b>GSP6500</b>	8595156226302	Gibljava cev 6/4" max.dolžina 950mm, DN 40/50	40	<b>2,501</b>
----------------	---------------	--	----	--------------

<b>GP-0129*</b>	8606009613184	Gibljava cev kratka Ø40 dolž.60cm NVM		<b>2,379</b>
-----------------	---------------	--	--	--------------

<b>GP-0132*</b>	8606009611203	Gibljava cev srednja Ø40 dolž.110cm NVM		<b>4,026</b>
-----------------	---------------	--	--	--------------

<b>GP-0128*</b>	8606009611180	Gibljava cev dolga Ø40 dolž.160cm NVM		<b>5,429</b>
-----------------	---------------	--	--	--------------

## SIFONSKA GUMI MANŠETA

Koda	EAN	Naziv	Pakiranje	Cena
<b>CG44C00</b>	8595156226555	Sifonska gumi manšeta 50-40	20	<b>0,964</b>
<b>CG43B00</b>	8595156226548	Sifonska gumi manšeta 50-30	20	<b>1,025</b>
<b>CG43A00</b>	8595156223363	Sifonska gumi manšeta 40-32	20	<b>0,964</b>

## TEFLONSKI TRAK

Koda	EAN	Naziv	Pakiranje	Cena
<b>WT12000</b>	8595156203099	Teflon trak 12 x 0,1 x 10mm PB	100	<b>0,622</b>
<b>WT19000</b>	8595156203105	Teflon trak 19 x 0,2 x 15mm PB	70	<b>2,989</b>

## ŽICA ZA ČIŠČENJE ODTOKOV

Koda	EAN	Naziv	Pakiranje	Cena
<b>TG-7615*</b>	8606009613474	Žica za čiščenje odtokov Ø8 x 6m		<b>19,764</b>
<b>TG-7616*</b>		Žica za čiščenje odtokov Ø8 x 8m		<b>26,352</b>
<b>TG-0482*</b>		Žica za čiščenje odtokov Ø8 x 10m		<b>32,940</b>
<b>TG-0693*</b>		Žica za čiščenje odtokov Ø10 x 8m		<b>34,587</b>
<b>TG-0483*</b>		Žica za čiščenje odtokov Ø10 x 10m		<b>43,646</b>
<b>TG-765</b>		Žica za čiščenje odtokov Ø10 x 12m		<b>52,375</b>

## MAST ZA PLASTIKO

Koda	EAN	Naziv	Pakiranje	Cena
<b>WM25010</b>	8595156227460	Mast za plastiko 250 g	50	<b>3,135</b>



## SIFONI ZA UMIVALNIK



Koda	EMCR001	EMCR002	EMCR003	EMCR004
EAN	8595156227033	8595156227040	8595156227057	8595156227064
Naziv	Sifon za umivalnik bučka S 5/4", DN32	Sifon za umivalnik lok, S 5/4", DN32	Sifon za umivalnik okrogli S 5/4", DN32	Sifon za umivalnik QUADRO S 5/4", DN32
Cena	26,93	23,45	50,86	64,32



Koda	EMCP001	EMCP002	EMCP003	EMCP004
EAN				
Naziv	Sifon za umivalnik Poseidon plastic, krom, S5/4", DN32	Sifon za umivalnik Poseidon plastic, bel, S5/4", DN32	Sifon za umivalnik Poseidon plastic, mat bel, S5/4", DN32	Sifon za umivalnik Poseidon plastic, mat črn, S5/4", DN32
Cena	40,48	23,47	55,09	55,09

## KLIK-KLAK SIFONI



Koda	EUVCR01	EUVCR02	EUVCR05	EUVCP01	EUVCP02	EUVCP03	EUVCP04
EAN	8595156224025	8595156224032	8595156230484				
Naziv	KLIK-KLAK kratki	KLIK-KLAK dolgi	KLIK-KLAK KVADRO	KLIK-KLAK kratki PVC krom	KLIK-KLAK kratki PVC inox	KLIK-KLAK kratki PVC beli	KLIK-KLAK kratki PVC črni
Cena	20,81	24,29	26,17	11,66	8,86	11,66	11,66

## SIFONI ZA PISOAR



Koda	ESO0550	ESO0551	ESO0341	EMCR005	ETT3250	ETT4250	EPPP000
EAN	8595156223783	8595156223790	8595156223967	8595156242746	8595156242104	8595156242104	
Naziv	Sifon za pisoar, horizontalni priključek, DN50	Sifon za pisoar, vertikalni, priključek, DN50	Sifon za pisoar DN40	Sifonska cev za podaljšanje DN32 / 143mm	Podaljšek sifona G 5/4", DN32, 30 / 250mm	Podaljšek sifona G 6/4", DN40, 35 / 250mm	Podaljšek sifona gibljivi G1" / 98mm
Cena	21,91	21,91	6,94	7,95	3,42	3,42	4,84

## SIFONI ZA TUŠ KAD



Koda	EWN0850	EWNN942	EWBN942	EWWN942	EWNN642
EAN	8595156222915	8595156242050	8595156262584	8595156210103	8595156241848
Naziv	Sifon za tuš kad 90/50 INOX	Sifon za tuš kad 90/40, INOX, nizki, koleno 45° - 40/50	Sifon za tuš kad 90/40 nizki, koleno 45° - 40/50, viš. 58mm, črn pokrov	Sifon za tuš kad 90/40 nizki, koleno 45° - 40/50, viš. 58mm, bel pokrov	Sifon za tuš kad 60/40 INOX nizki, koleno 45° 40/50
Cena	18,12	23,42	69,02	69,02	19,41

## SIFONI ZA KOPALNO KAD



Koda	EVS0150	EVS0147	EVSB141	EVSB147
EAN	8595156241060			
Naziv	Sifon za kopalno kad automatic, DN40/50, L=610mm	Sifon METAL za kopalno kad automatic, sifon 40, koleno 40/50, L=780mm	Sifon PLASTIC za kopalno kad automatic, črn, sifon 40, koleno 40/50, L=610mm	Sifon PLASTIC za kopalno kad automatic, črn, sifon 40/50, L=780mm
Cena	47,04	49,50	78,52	81,36



Koda	EVSC147	EVN1M50	EVSE147
EAN		8595156226234	
Naziv	Sifon CHROME za kopalno kad automatic, sifon 40, koleno 40/50, L=780mm	Sifon za kopalno kad automatic, DN50, L=550mm s polnjenjem	Sifon PLASTIC za kopalno kad automatic, črn, sifon 40, koleno 40/50, L=780mm
Cena	38,13	163,13	35,85

## ČEPI



Koda	YE40001	YE30001	YE31000	YE35000	EU04140	YE33000	YE34000
EAN	8595156221246	8595156221239	8595156223448	8595156223875	8595156212060	8595156223905	8595156223912
Naziv	Čep 6/4" (46 mm), verižica s čepom L 270mm	Čep 5/4" (39 mm), verižica s čepom L 270mm	Čep 46 mm, verižica s krogcem L440mm	Čep 46 mm, verižica s krogcem L 350mm	Čep 39mm	Čep 46mm	Čep 52mm
Cena	2,22	2,22	2,61	2,28	0,90	1,24	1,29

## PROTISMRADNE KAPE

## SIFONI KONDENZA

## SIFONI ZA PRALNI STROJ



Koda	<b>AVPO440</b>	<b>AVPT400</b>	<b>EK1P000</b>	<b>EPP1200</b>	<b>EPP1230</b>
EAN	8595156241350	8595156229303	8595156229310	8595156240964	
Naziv	Protismradna kapa T-kos bela DN40	Protismradna kapa T-kos z navojem bela DN40	Sifon kondenza PVC beli DN32	Sifon za pralni stroj PVC enojni nadometni, matica, 10 - 16mm	Sifon za pralni stroj PVC enojni nadometni, matica, 18 - 23mm
Cena	<b>10,46</b>	<b>10,46</b>	<b>7,38</b>	<b>1,64</b>	<b>1,65</b>



Koda	<b>EPVP000</b>	<b>EPVN000</b>	<b>EPPP450</b>	<b>EPPC450</b>	<b>EPP2300</b>	<b>EPP2330</b>
EAN	8595156222700	8595156222700	8595156220515	8595156223431		
Naziv	Sifon za pralni stroj PVC enojni nadometni, DN32 beli	Sifon za pralni stroj PVC enojni nadometni, DN32 krom	Sifon za pralni stroj PVC enojni podometni, DN40/50 beli	Sifon za pralni stroj PVC enojni podometni, DN40/50 krom	Sifon za pralni stroj PVC dvojni nadometni, matica, 2 x 18 - 23mm	Sifon za pralni stroj PVC dvojni nadometni, matica, 10-16 / 18-23mm
Cena	<b>3,37</b>	<b>6,32</b>	<b>4,39</b>	<b>6,38</b>	<b>10,46</b>	<b>10,46</b>



Koda	<b>EPPP452</b>	<b>EPT4200</b>	<b>EPT4300</b>	<b>EPT3200</b>	<b>EPT3300</b>
EAN	8595156242739				8595156219366
Naziv	Sifon za pralni stroj PVC dvojni podometni, 2 x DN40/50	Sifon za pralni stroj PVC dvojni nadometni, ploski, matica, 2 x 18-23mm	Sifon za pralni stroj PVC dvojni nadometni, ploski, matica, 10-16 / 18-23mm	Sifon za pralni stroj PVC nadometni z odvodom kondenza, protipovratni ventil, DN32 18-23mm	Sifon za pralni stroj PVC z odvodom kondenza, protipovratni ventil, DN32, 10-16 / 18-23mm
Cena	<b>12,38</b>	<b>10,46</b>	<b>10,46</b>	<b>10,46</b>	<b>10,46</b>

## TALNI SIFONI



Koda	<b>SI50D00</b>	<b>SI50C00</b>	<b>SI50G01</b>	<b>SI5TC01</b>	<b>SI5TG01</b>	<b>SIFTALPRETPILREM</b>	<b>SIFONSUHIPIL</b>
EAN	8595156230057	8595156202580	8595156241428	8595156225824	8595156241442	3830044752019	3830044752002
Naziv	Sifon talni suhi s protismradno zaporo za vgraditev keramike, DN50	Sifon talni suhi s protismradno zaporo, inox rešetka, DN50	Sifon talni suhi s protismradno gravitacijsko zaporo, inox rešetka, DN50	Sifon talni pretočni s protismradno zaporo, inox rešetka, DN50	Sifon talni pretočni s protismradno gravitacijsko zaporo, inox rešetka, DN50	Sifon talni pretočni Ø50, viš. 10cm	Sifon talni 1/1 suhi Ø50 PILREMAG, viš. 10cm
Cena	<b>28,74</b>	<b>14,73</b>	<b>22,08</b>	<b>20,88</b>	<b>36,75</b>	<b>9,31</b>	<b>5,00</b>

\*Po naročilu

## PVC ODTOČNA KANALETA KOMBI s kombiniranim sifonom (mokri/suhi) in INOX REŠETKO

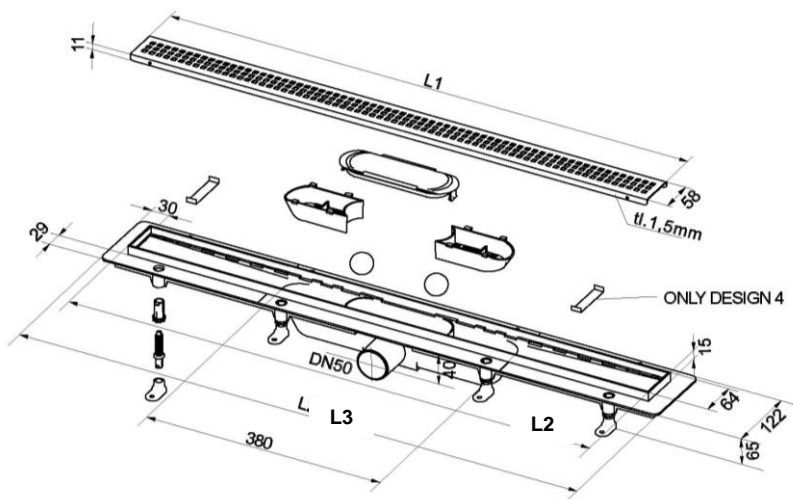

Design 1



Koda	EAN	Naziv	Dolž. rešetke L1(mm)	Dolžina kanala L2(mm)	Dolžina prirobnice L3(mm)	DN	Cena
<b>SZA1400</b> *	8595156218536	PVC kanaleta kombi INOX rešetka design 1 - 400mm	393	400	460	50	<b>79,32</b>
<b>SZA1550</b>	8595156218543	PVC kanaleta kombi INOX rešetka design 1 - 550mm	543	550	610	50	<b>84,44</b>
<b>SZA1650</b>	8595156218550	PVC kanaleta kombi INOX rešetka design 1 - 650mm	644	650	710	50	<b>97,33</b>
<b>SZA1750</b>	8595156218567	PVC kanaleta kombi INOX rešetka design 1 - 750mm	744	750	810	50	<b>100,43</b>
<b>SZA1850</b>	8595156218574	PVC kanaleta kombi INOX rešetka design 1 - 850mm	844	850	910	50	<b>105,94</b>

Design 2

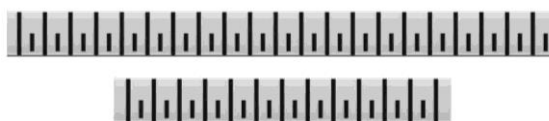

Koda	EAN	Naziv	Dolž. rešetke L1(mm)	Dolžina kanala L2(mm)	Dolžina prirobnice L3(mm)	DN	Cena
<b>SZA2400</b> *	8595156218581	PVC kanaleta kombi INOX rešetka design 2 - 400mm	393	400	460	50	<b>79,32</b>
<b>SZA2550</b> *	8595156218598	PVC kanaleta kombi INOX rešetka design 2 - 550mm	543	550	610	50	<b>84,44</b>
<b>SZA2650</b> *	8595156218604	PVC kanaleta kombi INOX rešetka design 2 - 650mm	644	650	710	50	<b>97,33</b>
<b>SZA2750</b> *	8595156218611	PVC kanaleta kombi INOX rešetka design 2 - 750mm	744	750	810	50	<b>100,43</b>
<b>SZA2850</b> *	8595156218628	PVC kanaleta kombi INOX rešetka design 2 - 850mm	844	850	910	50	<b>105,94</b>

Design 3

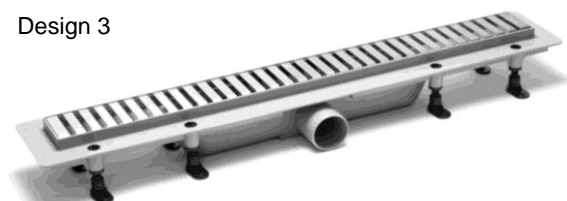

Koda	EAN	Naziv	Dolž. rešetke L1(mm)	Dolžina kanala L2(mm)	Dolžina prirobnice L3(mm)	DN	Cena
<b>SZA3400</b> *	8595156218635	PVC kanaleta kombi INOX rešetka design 3 - 400mm	393	400	460	50	<b>79,32</b>
<b>SZA3550</b> *	8595156218642	PVC kanaleta kombi INOX rešetka design 3 - 550mm	543	550	610	50	<b>84,44</b>
<b>SZA3650</b>	8595156218659	PVC kanaleta kombi INOX rešetka design 3 - 650mm	644	650	710	50	<b>97,33</b>
<b>SZA3750</b>	8595156218666	PVC kanaleta kombi INOX rešetka design 3 - 750mm	744	750	810	50	<b>100,43</b>
<b>SZA3850</b>	8595156218673	PVC kanaleta kombi INOX rešetka design 3 - 850mm	844	850	910	50	<b>105,94</b>

\*Po naročilu

## PVC ODTOČNA KANALETA KOMBI s kombiniranim sifonom (mokri/suhi) in INOX REŠETKO

Design 4 (2 v 1)



za keramiko debeline do 10mm



Koda	EAN	Naziv	Dolž. rešetke L1(mm)	Dolžina kanala L2(mm)	Dolžina prirobnice L3(mm)	DN	Cena
<b>SZA4400</b> *	8595156218680	PVC kanaleta kombi INOX rešetka design 4(2v1) - 400mm	393	400	460	50	<b>79,32</b>
<b>SZA4550</b> *	8595156218697	PVC kanaleta kombi INOX rešetka design 4(2v1) - 550mm	543	550	610	50	<b>84,44</b>
<b>SZA4650</b>	8595156218703	PVC kanaleta kombi INOX rešetka design 4(2v1) - 650mm	644	650	710	50	<b>97,33</b>
<b>SZA4750</b>	8595156218710	PVC kanaleta kombi INOX rešetka design 4(2v1) - 750mm	744	750	810	50	<b>100,43</b>
<b>SZA4850</b>	8595156218727	PVC kanaleta kombi INOX rešetka design 4(2v1) - 850mm	844	850	910	50	<b>105,94</b>

Design 5

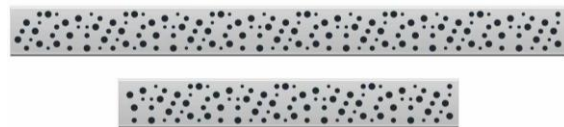

Koda	EAN	Naziv	Dolž. rešetke L1(mm)	Dolžina kanala L2(mm)	Dolžina prirobnice L3(mm)	DN	Cena
<b>SZA5400</b> *	8595156218734	PVC kanaleta kombi INOX rešetka design 5 - 400mm	393	400	460	50	<b>79,32</b>
<b>SZA5550</b> *	8595156218741	PVC kanaleta kombi INOX rešetka design 5 - 550mm	543	550	610	50	<b>84,44</b>
<b>SZA5650</b> *	8595156218758	PVC kanaleta kombi INOX rešetka design 5 - 650mm	644	650	710	50	<b>97,33</b>
<b>SZA5750</b> *	8595156218765	PVC kanaleta kombi INOX rešetka design 5 - 750mm	744	750	810	50	<b>100,43</b>
<b>SZA5850</b> *	8595156218772	PVC kanaleta kombi INOX rešetka design 5 - 850mm	844	850	910	50	<b>105,94</b>

Design 6



Koda	EAN	Naziv	Dolž. rešetke L1(mm)	Dolžina kanala L2(mm)	Dolžina prirobnice L3(mm)	DN	Cena
<b>SZA6400</b> *	8595156220201	PVC odtočna kanaleta kombi, INOX rešetka 6 - 400mm	393	400	460	50	<b>107,60</b>
<b>SZA6550</b> *	8595156220232	PVC odtočna kanaleta kombi, INOX rešetka 6 - 550mm	543	550	610	50	<b>120,52</b>
<b>SZA6650</b> *	8595156220287	PVC odtočna kanaleta kombi, INOX rešetka 6 - 650mm	644	650	710	50	<b>126,97</b>
<b>SZA6750</b> *	8595156220263	PVC odtočna kanaleta kombi, INOX rešetka 6 - 750mm	744	750	810	50	<b>134,51</b>
<b>SZA6850</b> *	8595156220317	PVC odtočna kanaleta kombi, INOX rešetka 6 - 850mm	844	850	910	50	<b>139,89</b>

\*Po naročilu

## PVC ODTOČNA KANALETA z mokrim sifonom in INOX OKVIRJEM in REŠETKO

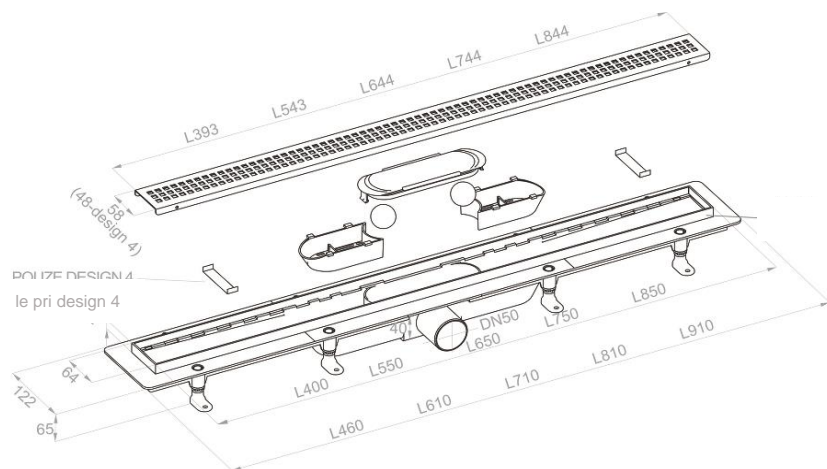

Design 1



Design 2



Design 3



Design 4 (2 v 1)

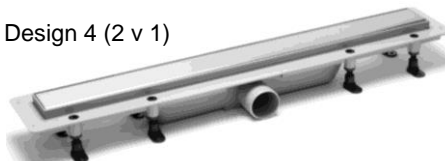

Design 5



Koda	EAN	Naziv	Dolž. rešetke L(mm)	Dolžina kanala L(mm)	Dolžina prirobnice L(mm)	DN	Cena
<b>SZH1400</b>		PVC odtočna kanaleta, INOX okvir in rešetka 1 - 400mm	393	400	460	50	<b>142,04</b>
<b>SZH1550</b>		PVC odtočna kanaleta, INOX okvir in rešetka 1 - 550mm	543	550	610	50	<b>156,03</b>
<b>SZH1650</b>		PVC odtočna kanaleta, INOX okvir in rešetka 1 - 650mm	644	650	710	50	<b>164,63</b>
<b>SZH1750</b>		PVC odtočna kanaleta, INOX okvir in rešetka 1 - 750mm	744	750	810	50	<b>173,24</b>
<b>SZH1850</b>		PVC odtočna kanaleta, INOX okvir in rešetka 1 - 850mm	844	850	910	50	<b>181,85</b>
<b>SZH2400</b>		PVC odtočna kanaleta, INOX okvir in rešetka 2 - 400mm	393	400	460	50	<b>142,04</b>
<b>SZH2550</b>		PVC odtočna kanaleta, INOX okvir in rešetka 2 - 550mm	543	550	610	50	<b>156,03</b>
<b>SZH2650</b>		PVC odtočna kanaleta, INOX okvir in rešetka 2 - 650mm	644	650	710	50	<b>164,63</b>
<b>SZH2750</b>		PVC odtočna kanaleta, INOX okvir in rešetka 2 - 750mm	744	750	810	50	<b>173,24</b>
<b>SZH2850</b>		PVC odtočna kanaleta, INOX okvir in rešetka 2 - 850mm	844	850	910	50	<b>181,85</b>
<b>SZH3400</b>		PVC odtočna kanaleta, INOX okvir in rešetka 3 - 400mm	393	400	460	50	<b>142,04</b>
<b>SZH3550</b>		PVC odtočna kanaleta, INOX okvir in rešetka 3 - 550mm	543	550	610	50	<b>156,03</b>
<b>SZH3650</b>		PVC odtočna kanaleta, INOX okvir in rešetka 3 - 650mm	644	650	710	50	<b>164,63</b>
<b>SZH3750</b>		PVC odtočna kanaleta, INOX okvir in rešetka 3 - 750mm	744	750	810	50	<b>173,24</b>
<b>SZH3850</b>		PVC odtočna kanaleta, INOX okvir in rešetka 3 - 850mm	844	850	910	50	<b>181,85</b>
<b>SZH4400</b>		PVC odtočna kanaleta, INOX okvir in rešetka 4 - 400mm	393	400	460	50	<b>142,04</b>
<b>SZH4550</b>		PVC odtočna kanaleta, INOX okvir in rešetka 4 - 550mm	543	550	610	50	<b>156,03</b>
<b>SZH4650</b>		PVC odtočna kanaleta, INOX okvir in rešetka 4 - 650mm	644	650	710	50	<b>164,63</b>
<b>SZH4750</b>		PVC odtočna kanaleta, INOX okvir in rešetka 4 - 750mm	744	750	810	50	<b>173,24</b>
<b>SZH4850</b>		PVC odtočna kanaleta, INOX okvir in rešetka 4 - 850mm	844	850	910	50	<b>181,85</b>
<b>SZH5400</b>		PVC odtočna kanaleta, INOX okvir in rešetka 5 - 400mm	393	400	460	50	<b>142,04</b>
<b>SZH5550</b>		PVC odtočna kanaleta, INOX okvir in rešetka 5 - 550mm	543	550	610	50	<b>156,03</b>
<b>SZH5650</b>		PVC odtočna kanaleta, INOX okvir in rešetka 5 - 650mm	644	650	710	50	<b>164,63</b>
<b>SZH5750</b>		PVC odtočna kanaleta, INOX okvir in rešetka 5 - 750mm	744	750	810	50	<b>173,24</b>
<b>SZH5850</b>		PVC odtočna kanaleta, INOX okvir in rešetka 5 - 850mm	844	850	910	50	<b>181,85</b>

\*Po naročilu

## INOX ODTOČNA KANALETA z mokrim sifonom in INOX OKVIRJEM in REŠETKO

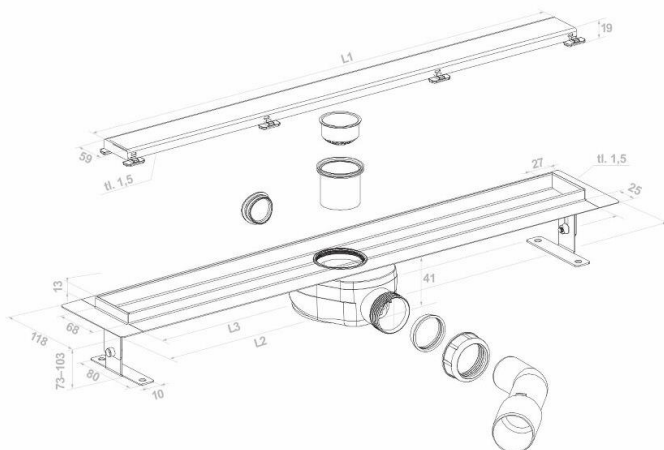

Design 2



Koda	EAN	Naziv	Dolž. rešetke L1 (mm)	Dolžina prirobnice L2 (mm)	Dolžina kanala L3 (mm)	DN	Cena
<b>SZU2650</b>		INOX odtočna kanaleta / rešetka design 2 - 650mm	650	708	651	40/50	<b>230,58</b>
<b>SZU2750</b>		INOX odtočna kanaleta / rešetka design 2 - 750mm	750	808	751	40/50	<b>248,51</b>
<b>SZU2850</b>		INOX odtočna kanaleta / rešetka design 2 - 850mm	850	908	851	40/50	<b>266,45</b>
<b>SZU2950</b>		INOX odtočna kanaleta / rešetka design 2 - 950mm	950	1008	951	40/50	<b>281,82</b>

Design 4



Koda	EAN	Naziv	Dolž. rešetke L1 (mm)	Dolžina prirobnice L2 (mm)	Dolžina kanala L3 (mm)	DN	Cena
<b>SZU4650</b>		INOX odtočna kanaleta / rešetka design 4 - 650mm	650	708	651	40/50	<b>235,70</b>
<b>SZU4750</b>		INOX odtočna kanaleta / rešetka design 4 - 750mm	750	808	751	40/50	<b>251,08</b>
<b>SZU4850</b>		INOX odtočna kanaleta / rešetka design 4 - 850mm	850	908	851	40/50	<b>271,57</b>
<b>SZU4950</b>		INOX odtočna kanaleta / rešetka design 4 - 950mm	950	1008	951	40/50	<b>286,94</b>

Design 5



Koda	EAN	Naziv	Dolž. rešetke L1 (mm)	Dolžina prirobnice L2 (mm)	Dolžina kanala L3 (mm)	DN	Cena
<b>SZU5650</b>		INOX odtočna kanaleta / rešetka design 5 - 650mm	650	708	651	40/50	<b>230,58</b>
<b>SZU5750</b>		INOX odtočna kanaleta / rešetka design 5 - 750mm	750	808	751	40/50	<b>248,51</b>
<b>SZU5850</b>		INOX odtočna kanaleta / rešetka design 5 - 850mm	850	908	851	40/50	<b>266,45</b>
<b>SZU5950</b>		INOX odtočna kanaleta / rešetka design 5 - 950mm	950	1008	951	40/50	<b>281,82</b>



\*Po naročilu

## INOX ODTOČNA KANALETA OB STENI z mokrim sifonom in INOX OKVIRJEM in REŠETKO

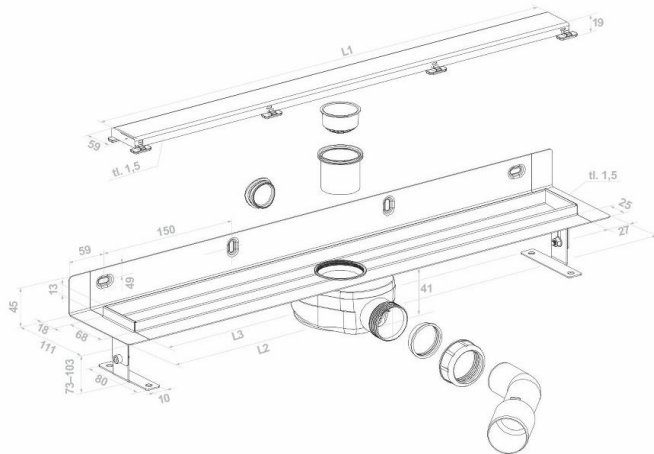

Design 2



Koda	EAN	Naziv	Dolž. rešetke L1 (mm)	Dolžina prirobnice L2 (mm)	Dolžina kanala L3 (mm)	DN	Cena
<b>SZZ2650</b>		INOX odtočna kanaleta ob steni, INOX rešetka 2 - 650mm	650	708	651	40/50	<b>240,83</b>
<b>SZZ2750</b>		INOX odtočna kanaleta ob steni, INOX rešetka 2 - 750mm	750	808	751	40/50	<b>256,20</b>
<b>SZZ2850</b>		INOX odtočna kanaleta ob steni, INOX rešetka 2 - 850mm	850	908	851	40/50	<b>274,13</b>
<b>SZZ2950</b>		INOX odtočna kanaleta ob steni, INOX rešetka 2 - 950mm	950	1008	951	40/50	<b>289,51</b>

Design 4



Koda	EAN	Naziv	Dolž. rešetke L1 (mm)	Dolžina prirobnice L2 (mm)	Dolžina kanala L3 (mm)	DN	Cena
<b>SZZ4650</b>		INOX odtočna kanaleta ob steni, INOX rešetka 4 - 650mm	650	708	651	40/50	<b>243,39</b>
<b>SZZ4750</b>		INOX odtočna kanaleta ob steni, INOX rešetka 4 - 750mm	750	808	751	40/50	<b>261,32</b>
<b>SZZ4850</b>		INOX odtočna kanaleta ob steni, INOX rešetka 4 - 850mm	850	908	851	40/50	<b>279,26</b>
<b>SZZ4950</b>		INOX odtočna kanaleta ob steni, INOX rešetka 4 - 950mm	950	1008	951	40/50	<b>294,63</b>

Design 5



Koda	EAN	Naziv	Dolž. rešetke L1 (mm)	Dolžina prirobnice L2 (mm)	Dolžina kanala L3 (mm)	DN	Cena
<b>SZZ5650</b>		INOX odtočna kanaleta ob steni, INOX rešetka 5 - 650mm	650	708	651	40/50	<b>240,83</b>
<b>SZZ5750</b>		INOX odtočna kanaleta ob steni, INOX rešetka 5 - 750mm	750	808	751	40/50	<b>256,20</b>
<b>SZZ5850</b>		INOX odtočna kanaleta ob steni, INOX rešetka 5 - 850mm	850	908	851	40/50	<b>274,13</b>
<b>SZZ5950</b>		INOX odtočna kanaleta ob steni, INOX rešetka 5 - 950mm	950	1008	951	40/50	<b>289,51</b>

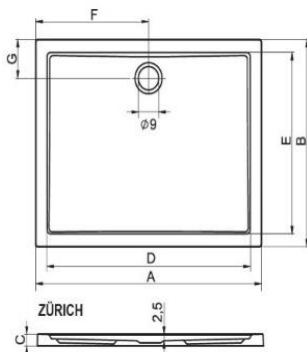

**TUŠ KAD ZÜRICH 250**

Koda	EAN	Cena
<b>D001007005</b>	8714148328774	<b>206,80</b>

Tuš kad Zurich 250  
 Material: akril  
 Dimenzije: 90cm x 90cm  
 Globina: 2,5cm  
 Višina: 4,5cm

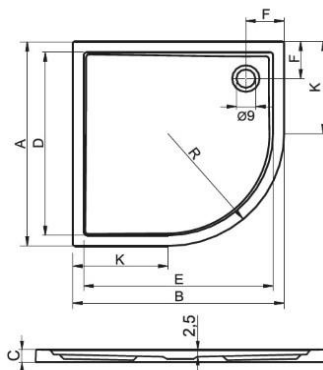

**TUŠ KAD ZÜRICH 280**

Koda	EAN	Cena
<b>D001022005</b>	8714148368824	<b>203,02</b>

Tuš kad Zurich 280  
 Material: akril  
 Dimenzije: 90cm x 90cm  
 Polkrožna z radijem 55cm  
 Globina 2,5cm  
 Višina 4,5cm

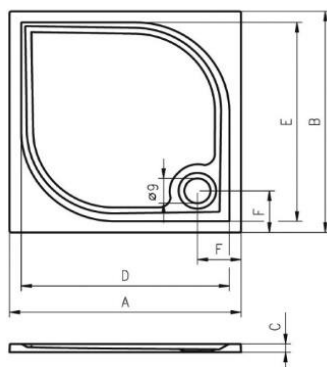

**TUŠ KAD KOLPING DB 21**

Koda	EAN	Cena
<b>D004005005</b>	8714148342527	<b>372,99</b>

Tuš kad Kolping DB 21  
 Material: liti marmor  
 Dimenzije: 90cm x 90cm  
 Globina: 1cm  
 Višina: 3cm

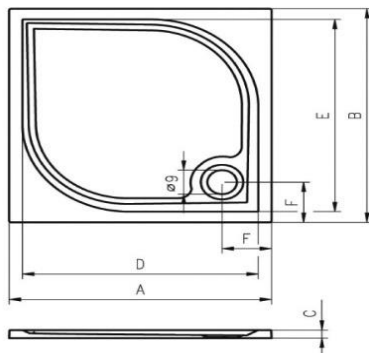

**TUŠ KAD KOLPING DB 31**

Koda	EAN	Cena
<b>D004006005</b>	8714148342541	<b>349,38</b>

Tuš kad Kolping DB 31  
 Material: liti marmor  
 Dimenzije: 80cm x 100cm  
 Globina: 1cm  
 Višina: 3cm

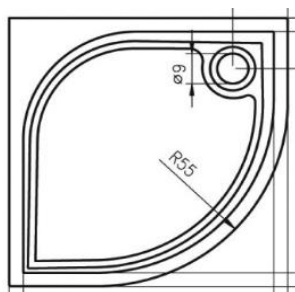

**TUŠ KAD KOLPING DB 14**

Koda	EAN	Cena
<b>D004002005</b>	8714148342473	<b>335,22</b>

Tuš kad Kolping DB 14  
 Material: liti marmor  
 Dimenzije: 90cm x 90cm  
 Polkrožna z radijem 55cm  
 Globina 1cm  
 Višina 3cm

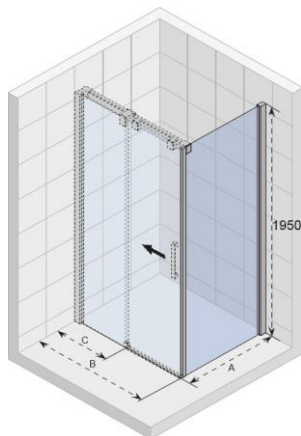

## TUŠ KABINA OCEAN kvadratna

Koda Cena

**G006004120 leva** **714,82**

EAN: 14148595480

**G006005120 desna** **714,82**

EAN: 14148595510

Tuš kabina Ocean 100 x 80cm

Širina vhodne stene: 965 - 990mm

Širina fiksne stene: 765 - 780mm

Višina: 1950mm

Vhod: 400mm

Zaščitni premaz proti vodnemu kamnu

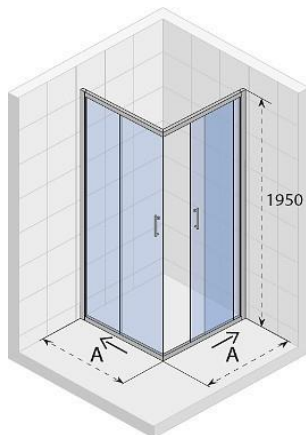

## TUŠ KABINA HAMAR kvadratna

Koda Cena

**G007005120** **458,92**

EAN: 14148592823

Tuš kabina Hamar 90 x 90cm

Širina: 870 - 905mm

Globina: 870 - 905 mm

Višina: 1950mm

Vhod: 500mm

Zaščitni premaz proti vodnemu kamnu

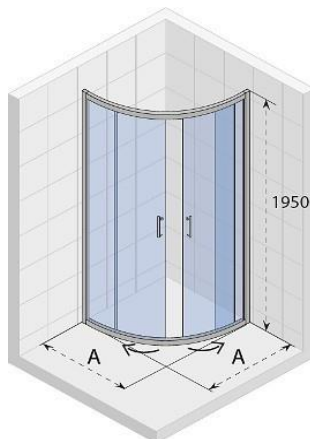

## TUŠ KABINA HAMAR polkrožna

Koda Cena

**G007002120** **488,20**

EAN: 14148592786

Tuš kabina Hamar 90 x 90cm, satinirana

Širina: 870 - 905mm

Globina: 870 - 905mm

Višina: 1950mm

Vhod: 520mm

Zaščitni premaz proti vodnemu kamnu

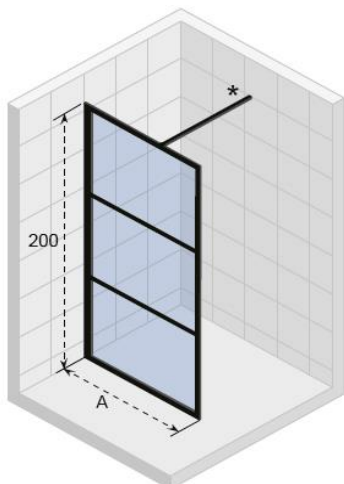

## TUŠ STENA GRID

Koda Cena

**G004027121** **618,50**

EAN: 14148577202

Tuš stena Grid 120cm

Širina: 1188 - 1198mm

Debelina stekla: 6mm

Višina: 2000mm

Oporni nosilec: dolžina 900mm

Okvir črn satiniran

Zaščitni premaz proti vodnemu kamnu

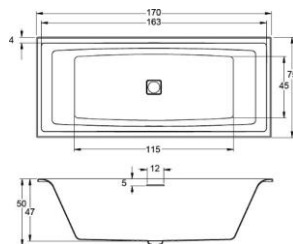

## STILL SQUARE (LED)

Koda Cena

**B100004005** **885,73**

EAN: 8714148571736

Vgradna kopalna kad  
Still Square Led 170 x 75cm, 265 litrov.  
LED osvetlitev.  
Vgradna višina 47cm (50) cm.

## LYRA

Koda Cena

**B019001005** **426,82**

EAN: 8714148313299

Kotna kopalna kad  
Lyra 140 x 90 cm, 200 litrov.  
Vgradna višina 42,5cm (46) cm.

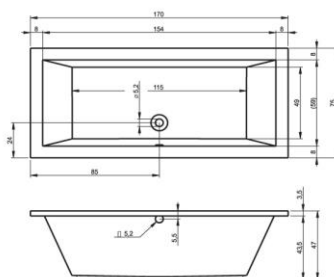
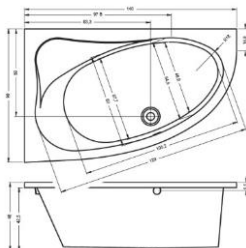

## LUSSO

Koda Cena

**B036001005** **597,73**

EAN: 8714148425039

Vgradna kopalna kad  
Lusso 180 x 80 cm, 295 litrov.  
Vgradna višina 44cm (47,5) cm

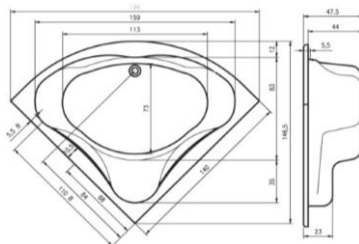

## NEO

Koda Cena

**B076001005** **509,91**

EAN: 8714148062630

Kotna kopalna kad  
Neo 140 x 140cm, 315 litrov.  
Vgradna višina 44cm (47,5) cm.

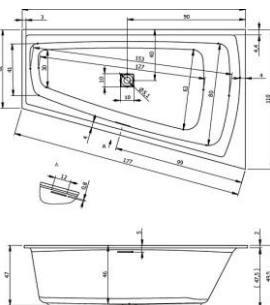

## STILL SMART (LED)

Koda Cena

**B101003005** **1.046,26**

EAN: 8714148572702

Kotna kopalna kad  
Still Smart Led 170 x 110 x 45cm, 320litrov  
Vgradna višina 47,5cm (49) cm.

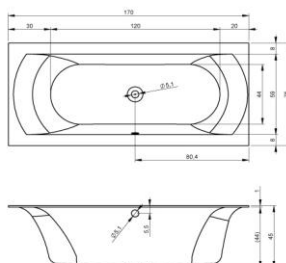

## LINARES

Koda Cena

**B141001005** **377,71**

EAN: 8714148547984

Vgradna kopalna kad  
Linares 170 x 75 cm, 210 litrov.  
Vgradna višina 44cm (45) cm.  
Debelina roba kadi samo 1cm!

## SERIJA NIKA



Koda	<b>NIKA60</b>	<b>NIKA-N1</b>	Po naročilu <b>NIKA-N2</b>	<b>NIKA-FI38</b>
EAN	8606008911113			
Naziv	Umivalnik Nika nadpultni brez luknje za pipo, š 60cm, g 36cm	Umivalnik Nika nadpultni š 50cm, g 36cm	Umivalnik Nika nadpultni š 60cm, g 36cm	Umivalnik Nika nadpultni okrogli premer 38cm
Cena	<b>142,04</b>	<b>134,94</b>	<b>151,51</b>	<b>123,58</b>



Koda	<b>500100</b>	<b>500200</b>	<b>SIN380</b>	<b>SL550</b>
EAN	8600198360188	8600198361789	8606008911052	8606008911038
Naziv	Wc školjka Nika konzolna z desko soft close g 55,5cm, š 37cm, v 35,4cm	Bide Nika konzolni g 55cm, š 38cm, v 33cm	Umivalnik Nika 380 š 38cm, g 32cm	Umivalnik Nika 550 š 55cm, g 46cm
Cena	<b>262,69</b>	<b>214,42</b>	<b>35,10</b>	<b>65,29</b>

## SERIJA VIKTORIJA - UMIVALNIKI



Koda	<b>SV07SR</b>	<b>SV01SR</b>	<b>SV06SR</b>
EAN	8606008910024	8606008910017	8606008910031
Naziv	Umivalnik Viktorija 500 š 52cm, g 42cm	Umivalnik Viktorija 600 š 60cm, g 48cm	Umivalnik Viktorija 460 š 46cm, g 37cm
Cena	<b>47,67</b>	<b>57,28</b>	<b>43,40</b>



Koda	<b>SL550PULT</b>	<b>SL650PULT</b>
EAN	8606008911038	
Naziv	Umivalnik polvgradni š 55cm, g 46cm	Umivalnik polvgradni š 65cm, g 51cm
Cena	<b>57,00</b>	<b>67,69</b>

## SERIJA VIKTORIJA - WC ŠKOLJKE IN BIDEJI



Koda	<b>SVB03</b>	<b>SVS03</b>	<b>SV05</b>
EAN	8606008910079	8606008910062	8606008910109
Naziv	Wc Viktorija baltik, stoječi, brez deske, stenski odtok	Wc Viktorija simplon, stoječi, brez deske, talni odtok	Bide Viktorija, stoječi
Cena	<b>59,78</b>	<b>59,78</b>	<b>79,68</b>



Koda	<b>SVS03KON</b>	<b>SV05KON</b>	<b>MONOVIKT</b> <small>odprodaja</small>
EAN	8606008910932	8606008911090	8606008910086
Naziv	Wc Viktorija viseči, brez deske	Bide Viktorija, viseči	Wc Viktorija monoblok z desko soft close komplet
Cena	<b>76,01</b>	<b>90,61</b>	<b>116,80</b>



Koda	<b>SVD03</b>	<b>OSSE000</b>	<b>LIV1409268201</b>
EAN	8606008910871	859515623030	8711778221307
Naziv	Wc Viktorija otroški, z desko, talni odtok simplon	Wc deska Sandra Soft close easy fix	Wc deska Virgo S
Cena	<b>103,99</b>	<b>36,45</b>	<b>40,26</b>

## SERIJA VIKTORIJA ZA STAROSTNIKE IN INVALIDE



Koda	<b>SVS60IK</b>	<b>SVS03IK</b>	<b>SVS03KONIK</b>
EAN		8606008910918	8606008911076
Naziv	Ergonomski umivalnik za starostnike in invalide š 61cm, g 50cm	Wc školjka Viktorija invalidska stoječa z desko, talni odtok	Wc školjka Viktorija invalidska viseča z desko
Cena	<b>134,12</b>	<b>200,61</b>	<b>227,74</b>

## PISOARJI



Koda	ZPN02	ZPN02BR	ZPN03-IZP	odprodaja	ZPN03
EAN	8606008910833	8606008910833			8606008910956
Naziv	Pisoar Poseidon s skritim sifonom, dotok zgoraj	Pisoar Poseidon s skritim sifonom, komplet vijakov, dotok zadaj	Klasični pisoar Eco z izpiranjem		Pisoar Eco brez izpiranja, s sifonom
Cena	<b>91,56</b>	<b>91,56</b>	<b>36,60</b>		<b>446,43</b>

## WC ČEPEČI (POLJSKI)

## TROKADERO



Koda	SV111	SVT01K	SVT01KBAL
EAN	8606008910505		8606008910895
Naziv	Wc čepeči (poljski)	Trokadero simplon s PVC rešetko, talni odtok	Trokadero baltik s PVC rešetko, stenski odtok
Cena	<b>93,64</b>	<b>321,25</b>	<b>321,25</b>

## SIFON

## PREGRADA ZA PISOAR

## PVC UMIVALNIK (GARAŽNI)



Koda	M25E	ZPNPREGRADA	VU50440	VU60440
EAN			8595156242074	8595156242081
Naziv	Rezervni sifon za Eco pisoar	Pregrada za pisoar ECO, POSEIDON	PVC umivalnik komplet, širina 50 cm	PVC umivalnik komplet, širina 60 cm
Cena	<b>195,14</b>	<b>82,28</b>	<b>44,29</b>	<b>45,63</b>

## GREEN - SERIJA na zalogi



Koda	<b>GR071CR</b>	<b>GR075CR</b>	<b>GR135CR</b>	<b>GR168CR</b>	<b>GR022CR</b>
EAN	8020913497775	8020913493548	8020913497881	8020913497904	8020913497713
Naziv	Armatura za umivalnik	Armatura za umivalnik s sifonom	Armatura za bide	Armatura za tuš brez izliva	Armatura za kopalno kad
Cena	<b>92,33</b>	<b>98,77</b>	<b>102,38</b>	<b>113,31</b>	<b>139,86</b>

## BLUE - SERIJA na zalogi



Koda	<b>BLU071CR</b>	<b>BLU075CR</b>	<b>BLU135CR</b>	<b>BLU168CR</b>	<b>BLU022CR</b>
EAN	8020913071630	8020913071746	8020913071753	8020913071975	8020913071661
Naziv	Armatura za umivalnik	Armatura za umivalnik s sifonom	Armatura za bide	Armatura za tuš brez izliva	Armatura za kopalno kad
Cena	<b>63,44</b>	<b>74,27</b>	<b>77,69</b>	<b>86,08</b>	<b>117,41</b>

## ELLE - SERIJA



Koda	<b>EL071CR</b>	<b>EL075CR</b>	<b>EL135CR</b>	<b>EL168CR</b>	<b>EL022CR</b>
EAN	8020913108787	8020913110216	8020913110377	8020913110438	8020913108718
Naziv	Armatura za umivalnik	Armatura za umivalnik s sifonom	Armatura za bide	Armatura za tuš brez izliva	Armatura za kopalno kad
Cena	<b>143,08</b>	<b>167,09</b>	<b>167,09</b>	<b>181,15</b>	<b>248,78</b>

## WEST - SERIJA na zalogi



Koda	<b>WS071CR</b>	<b>WS075CR</b>	<b>WS135CR</b>	<b>WS168CR</b>	<b>WS022CR</b>
EAN	8020913087112	8020913086672	8020913087167	8020913097708	8020913086689
Naziv	Armatura za umivalnik	Armatura za umivalnik s sifonom	Armatura za bide	Armatura za tuš brez izliva	Armatura za kopalno kad
Cena	<b>116,92</b>	<b>132,44</b>	<b>132,44</b>	<b>146,99</b>	<b>232,78</b>

## LIGHT - SERIJA dobavljiva v devetih različnih barvah



Koda	<b>LIG071CR</b>	<b>LIG075CR</b>	<b>LIG131CR</b>	<b>LIG168CR</b>	<b>LIG022CR</b>
EAN	8020913060863	8020913057832	8020913069132	8020913070749	8020913063710
Naziv	Armatura za umivalnik	Armatura za umivalnik s sifonom	Armatura za bide	Armatura za tuš brez izliva	Armatura za kopalno kad
Cena	<b>132,44</b>	<b>163,28</b>	<b>135,18</b>	<b>214,04</b>	<b>267,03</b>



## LIGHT - SERIJA matt black



Koda	<b>LIG071NO</b>	<b>LIG075NO</b>	<b>LIG131NO</b>	<b>LIG104NO</b>	<b>ZSCA050NO</b>
EAN	8020913530878	8020913540150	8020913536009	8020913581399	8020913459568
Naziv	Armatura za umivalnik	Armatura za umivalnik s sifonom	Armatura za bide	Armatura za umivalnik	Klik-klak sifon 1 1/4" SIMPLE RAPID
Cena	<b>172,26</b>	<b>212,18</b>	<b>175,68</b>	<b>301,10</b>	<b>42,46</b>



Koda	<b>LIG081NO</b>	<b>LIG285NO-MET</b>	<b>LIG280NO</b>	<b>LIG179NONO</b>	<b>ZDUP110NO</b>	<b>ZSUP031NO</b>
EAN	8020913530885	8020913536931	8020913536870	8020913536955	8020913554089	8020913487554
Naziv	Armatura za umivalnik	Armatura za umivalnik	Armatura za umivalnik	Armatura za kuhinjo	WC tuš ročka TWEET ROUND MIX	WC ventil za tuš ročka TONDO
Cena	<b>292,60</b>	<b>283,82</b>	<b>232,48</b>	<b>439,49</b>	<b>148,94</b>	<b>55,14</b>



Koda	<b>LIG168NO</b>	<b>LIQ168ENO</b>	<b>LIG022NO</b>
EAN	8020913536016	8020913528127	8020913535897
Naziv	Armatura za tuš brez izliva	Armatura za tuš brez izliva termostatska ECOSTOP	Armatura za tuš / kopalno kad
Cena	<b>278,36</b>	<b>243,51</b>	<b>347,36</b>

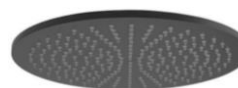

Koda	<b>LIG015NO</b>	<b>LIG018NO</b>	<b>ZSOF034NO</b>	<b>ZSOF079NO</b>	<b>ZSOF074NO</b>
EAN	8020913530441	8020913530458	8020913487578	8020913545223	8020913486519
Naziv	Armatura za tuš podometna	Armatura za tuš podometna	Stenski nosilec d=40cm, okrogli	Stropna pršna glava okrogla D=30cm MASTER KING	Stropna pršna glava okrogla D=22,5cm MASTER
Cena	<b>213,35</b>	<b>337,89</b>	<b>71,74</b>	<b>287,92</b>	<b>136,54</b>



Koda	<b>ZCOL638LIQNO</b>	<b>ZSAL146NO</b>	<b>ZDOC067NO</b>	<b>ZDOC125NO</b>	<b>ZFLO071NO</b>
EAN	8020913582730	8020913585229	8020913536030	8020913585175	8020913534357
Naziv	Tuš konzola z ročico in cevjo MINI BIRILLO, glava MASTER	Tuš konzola z ročico LIFE GINEVRA viš.755mm	Pršna ročica MASTER	Pršna ročica GINEVRA	Pršna cev Twist-free 150cm
Cena	<b>785,39</b>	<b>175,48</b>	<b>41,28</b>	<b>45,19</b>	<b>21,96</b>

## STENSKI PRŠNI SETI



Koda	<b>ZSAL112CR</b>	<b>ZSAL121CR</b>	<b>ZCOL643CR</b>	<b>KITLIG015CR</b>
EAN	8020913064656	8020913064694		8020913498024
Naziv	Tuš konzola TRIESTE z ročico, milnikom in cevjo	Tuš konzola QUEEN z ročico, milnikom in cevjo	Pršni tuš set termostatski	Podometni komplet za tuš kabino
Cena	<b>41,48</b>	<b>48,21</b>	<b>328,94</b>	<b>373,22</b>

## STROPNE PRŠNE GLAVE



Koda	<b>ZSOF074CR</b>	<b>ZSOF034CR</b>	<b>ZSOF075CR</b>	<b>ZSOF063CR</b>
EAN	8020913063628	8020913065172	8020913063659	8020913065189
Naziv	Stropna pršna glava okrogla D=225mm	Stenski nosilec d=40cm, okrogli	Stropna pršna glava 200 x 200mm	Stenski nosilec d=40cm, kvadratni
Cena	<b>102,87</b>	<b>55,53</b>	<b>114,09</b>	<b>83,16</b>

## TUŠ ROČICE



Koda	<b>ZDOC081CR</b>	<b>ZFLO001CR</b>	<b>ZSUP010CR</b>	<b>8206812</b>
EAN	8020913092260	8020913045297	8020913057122	7394326808000
Naziv	Pršna ročica TRIESTE	Pršna cev Twist-free 150cm	Zidni nosilec tuš ročice	Tuš ročica HANDY SW kromirana
Cena	<b>6,34</b>	<b>9,96</b>	<b>2,83</b>	<b>35,38</b>

Preprosta montaža na armaturo v kopalnici, kuhinji, navoj DN15, pritrdilni ventil, 1,5m fleksibilne cevi, tuš ročica s tipko za izmenično uporabo tuš - pipa.

## KUHINJSKE ARMATURE na zalogi



Koda	<b>WS285CR</b>	<b>NT183CR</b>	<b>NT182CR</b>	<b>GR180CR</b>
EAN	8020913087297	8020913033805	8020913033799	8020913497911
Naziv	Kuhinjska armatura WEST izvlečna	Kuhinjska armatura NETTUNO izvlečna	Kuhinjska armatura NETTUNO izvlečna s tremi cevčkami za tlačni bojler	Kuhinjska armatura OMBRELLO
Cena	<b>179,10</b>	<b>141,52</b>	<b>113,61</b>	<b>107,56</b>

## OGLEDALA



Koda	<b>ZP 16000R</b>	<b>ZP 16000RV</b>	<b>ZP 26002RV</b>	<b>ZP 8003</b>
EAN	8595187110946	8595187112940		8595187110878
Naziv	Okroglo ogledalo z integrirano LED lučjo 60cm	Okroglo ogledalo z integrirano LED lučjo 60cm, senzor na dotik	Okroglo ogledalo z integrirano LED lučjo 80cm, senzor na dotik	Kvadratno ogledalo z integrirano LED lučjo 80 x 60cm
Cena	<b>209,60</b>	<b>247,42</b>	<b>419,68</b>	<b>209,60</b>



Koda	<b>ZP 18002V</b>	<b>ZP 11002V</b>	<b>ZP 12003V</b>	<b>ZP 13003V</b>	<b>ZP 14002V</b>
EAN	8595187113008	8595187112803	8595187112827	8595187112889	8595187112926
Naziv	Kvadratno ogledalo z integrirano LED lučjo 60 x 80cm, senzor na dotik	Kvadratno ogledalo z integrirano LED lučjo 60 x 80cm, senzor na dotik	Kvadratno ogledalo z integrirano LED lučjo 80 x 70cm, senzor na dotik	Kvadratno ogledalo z integrirano LED lučjo 80 x 70cm, senzor na dotik	Kvadratno ogledalo z integrirano LED lučjo 60 x 80cm, senzor na dotik
Cena	<b>323,06</b>	<b>310,49</b>	<b>314,64</b>	<b>323,06</b>	<b>352,46</b>

## KIBO - na zalogi



Koda	<b>Ki 14058K-26</b>	<b>Ki 14031K-26</b>	<b>Ki 14059K-26</b>	<b>Ki 14055E-26</b>	<b>Ki 14055g-26</b>	<b>Ki 14055-26</b>
EAN	8595187105904	8595187105881	8595187105898	8595187106109	8595187106093	8595187106086
Naziv	Kozarec za ščetke, keramika	Milnik za tekoče milo, keramika	Skodelica za milo, keramika	Držalo wc papirja E	Držalo wc papirja G	Držalo wc papirja
Cena	<b>37,82</b>	<b>41,97</b>	<b>37,82</b>	<b>33,18</b>	<b>33,18</b>	<b>37,82</b>



Koda	<b>Ki 14094KN-26</b>	<b>Ki 14094K-26</b>	<b>Ki 14096-26</b>	<b>Ki 14061-26</b>	<b>Ki 14046-26</b>	<b>Ki 14053-26</b>
EAN	8595187109643	8595187106116	8595187106079	8595187106031	8595187106024	8595187105980
Naziv	Wc ščetka keramična viseča mala	Wc ščetka keramična viseča velika	Nosilec brisač dvojni pregibni, 38cm	Nosilec brisač 63cm	Nosilec brisač 48cm	Obešalnik dvojni
Cena	<b>48,68</b>	<b>74,30</b>	<b>62,95</b>	<b>67,22</b>	<b>54,53</b>	<b>20,98</b>



Koda	<b>Ki 14003-26</b>	<b>Ki 14015-26</b>	<b>Ki 14003H-26</b>	<b>Ki 14015H-26</b>	<b>Ki 14017D-26</b>	<b>Ki 14001H-26</b>
EAN	8595187105812	8595187105829	8595187105850	8595187105867	8595187105836	8595187105874
Naziv	Košarica za v tuš kotna 85 x 67 x 230mm	Košarica za v tuš 178 x 105 x 85mm	Košarica za v tuš kotna z obešalom 390 x 167 x 230mm	Košarica za v tuš viseča enojna 390 x 105 x 178mm	Košarica za v tuš dvojna 337 x 140 x 228mm	Obešalo za košarico v tušu
Cena	<b>54,53</b>	<b>50,39</b>	<b>67,22</b>	<b>62,95</b>	<b>121,76</b>	<b>18,42</b>

## KIBO black matt

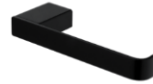

Koda	<b>Ki 14031K-T-90</b>	<b>Ki 14058K-90</b>	<b>Ki 14059K-90</b>	<b>Ki 14055g-90</b>	<b>Ki 14094K-90</b>	<b>Ki 14094KN-90</b>
EAN	8595187112216	8595187112261	8595187112278	8595187112254	8595187112360	8595187112377
Naziv	Milnik za tekoče milo, keramika	Kozarec za ščetke, keramika	Skodelica za milo, keramika	Držalo wc papirja	Wc ščetka viseča, keramika	Wc ščetka viseča nizka, keramika
Cena	<b>62,95</b>	<b>46,24</b>	<b>46,24</b>	<b>40,75</b>	<b>96,62</b>	<b>58,80</b>



Koda	<b>Ki 14053-90</b>	<b>Ki 14060g-90</b>	<b>Ki 14046-90</b>	<b>Ki-14091B-30-90</b>	<b>Ki-14091B-40-90</b>	<b>Ki 14091B-50-90</b>
EAN	8595187112247	8595187112285	8595187112223	8595187112308	8595187110137	8595187112322
Naziv	Obešalnik dvojni	Nosilec brisač 25cm	Nosilec brisač 48cm	Polica, 30cm x 12,3cm, satinirano belo steklo	Polica, 40cm x 12,3cm, satinirano belo steklo	Polica, 50cm x 12,3cm, satinirano belo steklo
Cena	<b>24,28</b>	<b>46,24</b>	<b>67,22</b>	<b>48,31</b>	<b>50,39</b>	<b>44,53</b>

## NIKAU black matt



Koda	<b>NKC 30031K-T-90</b>	<b>NKC 30031C-T-90</b>	<b>NKC 30031H-T-90</b>	<b>NKC 30058K-90</b>	<b>NKC 30058C-90</b>	<b>NKC 30058H-90</b>
EAN	8595187114920	8595187114913		8595187115002	8595187114999	
Naziv	Milnik za tekoče milo, kratki, keramika	Milnik za tekoče milo, kratki, steklo	Milnik za tekoče milo, dolgi, keramika	Kozarec za ščetke, kratki, keramika	Kozarec za ščetke, kratki, steklo	Kozarec za ščetke, dolgi, keramika
Cena	<b>79,67</b>	<b>84,67</b>	<b>84,67</b>	<b>59,41</b>	<b>63,93</b>	<b>63,93</b>



Koda	<b>NKC 30059K-90</b>	<b>NKC 30059C-90</b>	<b>NKC 30055-90</b>	<b>NKC 30055R-90</b>	<b>NKC 30094KN-90</b>	<b>NKC 30094CN-90</b>
EAN	8595187115026	8595187115019	8595187114975	8595187114982	8595187115125	8595187115118
Naziv	Skodelica za milo, keramika	Skodelica za milo, steklo	Držalo wc papirja	Držalo wc papirja vertikalno	Wc ščetka viseča, keramika	Wc ščetka viseča, steklo
Cena	<b>59,41</b>	<b>63,93</b>	<b>50,39</b>	<b>50,39</b>	<b>75,15</b>	<b>85,16</b>



Koda	<b>NKC 30054-90</b>	<b>NKC 30097-90</b>	<b>NKC 30098-90</b>	<b>NKC 30035-90</b>	<b>NKC 30046-90</b>	<b>NKC 30061-90</b>
EAN	8595187114968	8595187115149	8595187115156	8595187114937	8595187114944	8595187115040
Naziv	Obešalnik enojni kljukica	Držalo brisač 39cm	Držalo brisač dvojni, 39cm	Nosilec brisač 39cm	Nosilec brisač 49cm	Nosilec brisač 63cm
Cena	<b>24,16</b>	<b>68,93</b>	<b>100,77</b>	<b>75,15</b>	<b>85,16</b>	<b>100,77</b>



















Koda	<b>NKC X320-C-90</b>	<b>NKC X330-C-90</b>	<b>NKC X340-C-90</b>	<b>NKC X350-C-90</b>	<b>NKC 30091B-50-90</b>	<b>NKC 30091B-60-90</b>
EAN	8595187115255	8595187115262	8595187115279	8595187115286	8595187115088	8595187115095
Naziv	Polica, 20cm x 12,5cm črno mat steklo	Polica, 30cm x 12,5cm črno mat steklo	Polica, 40cm x 12,5cm črno mat steklo	Polica, 50cm x 12,5cm črno mat steklo	Polica, 50cm x 11,5cm satinirano belo steklo	Polica, 60cm x 11,5cm satinirano belo steklo
Cena	<b>55,51</b>	<b>60,51</b>	<b>65,39</b>	<b>70,52</b>	<b>60,51</b>	<b>63,56</b>

## UNIX - na zalogi

					
Koda <b>UN 13031W-T-26</b>	<b>UN 13059W-26</b>	<b>UN 13054-26</b>	<b>UN 13053-26</b>	<b>UN 13054N-26</b>	<b>UN 13060-26</b>
EAN 8595187112568	8595187109636	8595187104785	8595187104792	8595187104778	8595187104808
Naziv Držalo za trdo milo mat steklo	Držalo za trdo milo satin steklo	Obešalnik krom	Obešalnik dvojni krom	Obešalnik kljukica, krom	Držalo za brisače okroglo, krom
Cena <b>44,90</b>	<b>27,69</b>	<b>12,57</b>	<b>13,79</b>	<b>10,49</b>	<b>22,69</b>
					
Koda <b>UN 13055B-26</b>	<b>UN 13055M-26</b>	<b>UN 13058W-26</b>	<b>UN 13058DW-26</b>	<b>UN 13031W-26</b>	<b>UN 13031MN-26</b>
EAN 8595187104952	8595187104969	8595187106376	8595187106383	8595187106369	8595187106130
Naziv Držalo za toaletni papir s pokrovom, krom	Držalo za toaletni papir palica, krom	Kozarec za ščetke satin steklo	Kozarec 2x za ščetke satin steklo	Držalo za tekoče milo satin steklo	Milnik za tekoče milo, krom, odprodaja
Cena <b>29,40</b>	<b>26,84</b>	<b>27,69</b>	<b>41,97</b>	<b>36,51</b>	<b>44,90</b>
					
Koda <b>UN 13035-26</b>	<b>UN 13046-26</b>	<b>UN 13061D-26</b>	<b>UN 13096-26</b>	<b>UN 13096N-26</b>	<b>UN 13054-5-26</b>
EAN 8595187104853	8595187104860	8595187104877	8595187104914	8595187109605	8595187104839
Naziv Držalo za brisače 35cm, krom	Držalo za brisače 50cm, krom	Držalo brisač dvojno 66cm	Držalo brisač dvojno konzola 41cm	Držalo brisač dvojno konzola 41cm	Držalo za brisače 5 kljukic, krom
Cena <b>24,77</b>	<b>29,40</b>	<b>40,26</b>	<b>39,89</b>	<b>37,82</b>	<b>33,55</b>
					
Koda <b>UN 13011-26</b>	<b>UN 13012-26</b>	<b>UN 13091B-40-26</b>	<b>UN 13094WN-26</b>	<b>UN 13094E-26</b>	<b>UN 13095K-26</b>
EAN 8595187109582	8595187109599	8595187110182	8595187110274	8595187105034	8595187105218
Naziv Držalo sušilca za lase	Čistilec stekla v tušu	Polica, 40cm, belo steklo	Wc ščetka viseča, mat steklo	Wc ščetka viseča / talna, inox	Prostostoječi set z wc ščetko in držalom za toaletni papir
Cena <b>29,40</b>	<b>33,18</b>	<b>33,55</b>	<b>36,97</b>	<b>52,09</b>	<b>134,44</b>

## MONOLIT - projektna serija

					
Koda <b>MO 4031C-P-26</b>	<b>MO 4059C-26</b>	<b>MO 4058C-26</b>	<b>MO 4055-26</b>	<b>MO 4055B-26</b>	<b>MO 4054-26</b>
EAN 8595187105386	8595187104006	8595187103993	8595187103979	8595187103962	8595187103986
Naziv Milnik za tekoče milo mat steklo	Milnik za trdo milo mat steklo	Kozarec za ščetke mat steklo	Držalo za wc papir	Držalo za wc papir s pokrovom	Obešalnik-kljukica
Cena <b>14,27</b>	<b>12,57</b>	<b>12,57</b>	<b>13,42</b>	<b>14,64</b>	<b>5,86</b>
					
Koda <b>MO 4094C-26</b>	<b>OP 106-26</b>	<b>OP 111N-26</b>	<b>OP 101N-26</b>	<b>OP 112N-26</b>	<b>MO 4096-26</b>
EAN 8595187104037	8595187104488	8595187106826	8595187105089	8595187109247	8595187104075
Naziv Wc ščetka viseča mat steklo	Milnik za trdo milo kotni 17,5 x 17,5 x 10cm	Milnik za trdo milo ravni 13,5 x 9,3 x 3,3cm	Milnik za trdo milo kotni 13,5 x 13,5 x 3,3cm	Milnik za trdo milo ravni 10 x 11 x 20cm	Držalo brisač dvojno 49cm
Cena <b>25,13</b>	<b>30,62</b>	<b>19,28</b>	<b>20,98</b>	<b>31,84</b>	<b>19,28</b>
					
Koda <b>MO 4046-26</b>	<b>BM 7235-18</b>	<b>MO 4061D-26</b>	<b>MO 4091X-26</b>		
EAN 8595187104044	8595187102583	8595187104051			
Naziv Nosilec brisač 50cm	Ročaj 40cm x 25cm	Nosilec brisač 68cm - dvojni	Polica z ograjico 40cm, steklo		
Cena <b>19,76</b>	<b>24,28</b>	<b>29,40</b>	<b>25,13</b>		

\* Po naročilu

## KOPALNIŠKI DODATKI ZA STAROSTNIKE IN INVALIDE



Koda	EH-NWA-60-PCX	EH-NWA-70-PCX	EH-NWA-80-PCX	EHP-FA-70-PC	EH-N12-PCX	EH-N18-PCX	EH-N24-PCX
EAN	8034055106860	8034055106815	8034055106877	8034055102343	8034055106778	8034055106785	8034055106792
Naziv	Držalo pregibno stensko, 60cm, plastificirano	Držalo pregibno stensko, 70cm, plastificirano	Držalo pregibno stensko, 80cm, plastificirano	Držalo pregibno stoječe, 70cm, plastificirano	Držalo ravno stensko, 30cm, plastificirano	Držalo ravno stensko, 45cm, plastificirano	Držalo ravno stensko, 60cm, plastificirano
Cena	<b>89,06</b>	<b>96,38</b>	<b>103,70</b>	<b>284,26</b>	<b>34,16</b>	<b>37,82</b>	<b>42,70</b>

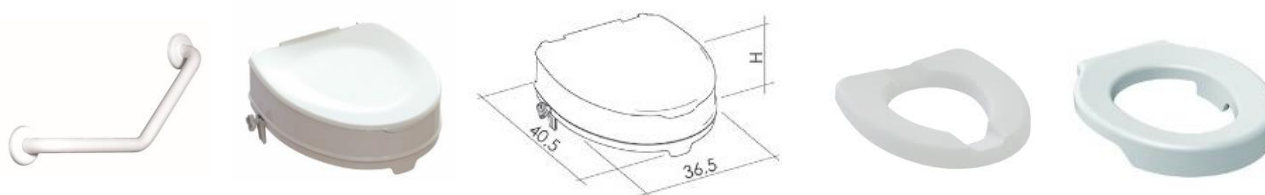

Koda	EH-N1212-PCX	AR-6-L-PP-KD	AR-10-L-PP-KD	PRC-CRTS-E-AX *	PR-STC-E-BX *
EAN	8034055101612	8034055104002	8034055104026		
Naziv	Držalo 45° stensko, 30 x 30cm, plastificirano	WC sedež povišan (6cm) s pokrovom in pritrilnim mehanizmom	WC sedež povišan (10cm) s pokrovom in pritrilnim mehanizmom	WC sedež dodatni za povišani sedež AR-10-L-PP-KD	WC varnostni sedež elastičen 39 x 44cm (za vse tipe wc školjk)
Cena	<b>41,00</b>	<b>80,52</b>	<b>84,18</b>	<b>42,58</b>	<b>117,00</b>



Koda	EHP-M6065-PCX	EH-BS-PP-BX *	PR-BS-PP-BX	PR-WS-PP-BX
EAN	8034055105498	8034055105399		8034055100226
Naziv	Ogledalo, ročno nastavljivo, belo, 60 x 65 x 11cm	Sedež za kopalno kad, bel, 67-77 x 30 x 18cm	Sedež za kopalno kad PVC, bel, š42 x g41 x v22cm	Sedež za tuš kabino, stenski, bel, 42 x 51 x 11cm
Cena	<b>230,58</b>	<b>84,18</b>	<b>140,30</b>	<b>181,78</b>



Koda	PR-StA-PP-B	EH-StA-PP-BX	EH-SS-PP-BX	EH-SSA-PP-BX
EAN	8034055100134	8034055105412	8034055105429	8034055105450
Naziv	Stolček za tuš kabino, bel / aluminij, 37cm, teleskopske noge 40-55cm	Stolček za tuš kabino, bel / aluminij, 30,5 x 30,5cm, teleskopske noge 39-54cm	Stolček za tuš kabino, bel / aluminij, 50 x 30cm, teleskopske noge 39-54cm	Stolček za tuš kabino z ročaji, bel / aluminij, 50 x 30cm, teleskopske noge 39-54cm
Cena	<b>108,58</b>	<b>79,30</b>	<b>108,58</b>	<b>145,18</b>

## GRELNI SET PRESTIGE LINE S TOUCH SCREEN TERMOSTATOM TVT45 in WI-FI funkcijo



Koda	EAN	Površina (m <sup>2</sup> )	Moč(W)	Cena
<b>TVK 410 SET TV TO 170</b>	5901812598165	1m <sup>2</sup>	170W	<b>202,91</b>
<b>TVK 415 SET TV TO 170</b>	5901812598172	1,5m <sup>2</sup>	255W	<b>220,10</b>
<b>TVK 420 SET TV TO 170</b>	5901812598189	2m <sup>2</sup>	340W	<b>244,10</b>
<b>TVK 425 SET TV TO 170</b>	5901812598196	2,5m <sup>2</sup>	425W	<b>256,21</b>
<b>TVK 430 SET TV TO 170</b>	5901812598066	3m <sup>2</sup>	510W	<b>271,55</b>
<b>TVK 435 SET TV TO 170</b>	5901812598073	3,5m <sup>2</sup>	595W	<b>288,71</b>
<b>TVK 440 SET TV TO 170</b>	5901812598745	4m <sup>2</sup>	680W	<b>305,88</b>
<b>TVK 450 SET TV TO 170</b>	5901812598752	5m <sup>2</sup>	850W	<b>333,35</b>
<b>TVK 460 SET TV TO 170</b>	5901812598769	6m <sup>2</sup>	1020W	<b>397,62</b>
<b>TVK 470 SET TV TO 170</b>	5901812598776	7m <sup>2</sup>	1190W	<b>433,06</b>
<b>TVK 480 SET TV TO 170</b>	5901812598783	8m <sup>2</sup>	1360W	<b>466,05</b>
<b>TVK 490 SET TV TO 170</b>	5901812598790	9m <sup>2</sup>	1530W	<b>501,85</b>
<b>TVK 4-10 SET TV TO 170</b>	5901812598813	10m <sup>2</sup>	1700W	<b>573,91</b>
<b>TVK 4-12 SET TV TO 170</b>	5901812597700	12m <sup>2</sup>	1800W	<b>609,60</b>
<b>TVK 4-15 SET TV TO 170</b>		15m <sup>2</sup>	1800W	<b>729,56</b>
<b>TVK 4-16 SET TV TO 170</b>	5901812597731	16m <sup>2</sup>	2400W	<b>744,20</b>



## ELEKTRIČNI RADIATORJI STYLO

Koda	EAN	Dimenzije (cm)	Moč (W)	Cena
<b>Stylo 500</b>		47 x 41 x 7,5	500	<b>146,00</b>
<b>Stylo 1000</b>		71 x 41 x 7,5	1000	<b>166,01</b>
<b>Stylo 1500</b>		96 x 41 x 7,5	1500	<b>196,01</b>
<b>Stylo 2000</b>		116 x 41 x 7,5	2000	<b>217,00</b>

Konvekcijski električni radiator, montažna globina 11,5cm (montažni set), regulacija moči ogrevanja, možnost timerja s tedensko nastavitvijo, dodatno IR modul in daljinec. Garancija 2 leti.



## INFRARDEČI SEVALNI PANELI ECOSUN U+

Koda	Ogrevanje	Dimenzije (mm)	Moč (W)	Cena
<b>ECOSUN 300 U+</b>	do 9m <sup>2</sup>	592 x 592 x 30	300	<b>167,80</b>
<b>ECOSUN 600 U+</b>	do 11m <sup>2</sup>	1192 x 592 x 30	600	<b>248,79</b>
<b>ECOSUN 700 U+</b>	do 16m <sup>2</sup>	1192 x 592 x 30	700	<b>268,80</b>
<b>ECOSUN 850 U+</b>	do 22m <sup>2</sup>	1192 x 800 x 30	850	<b>298,80</b>

Montaža strop / stena. Regulacija s klasičnim sobnim termostatom.



## KOPALNIŠKI INFRARDEČI SEVALNI PANELI

Koda	Ogrevanje	Dimenzije (cm)	Moč (W)	Cena
<b>ACANTO 110</b>	do 6m <sup>2</sup>	101 x 52 x 4,5	450	<b>366,00</b>
<b>HELISEA 110</b>	do 6m	101 x 52 x 4,5	450	<b>463,60</b>

Pritrditev na steno, obračanje 180°. Barva bela ali aluminij, držala siva. Termostatska regulacija s timerjem ogrevanja 15-30-60-120 minut. Zaščita proti vlagi IP24. Teža 5kg.

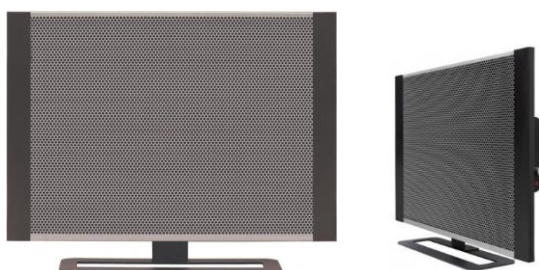

## PRENOSNI INFRARDEČI GRELNI PANEL HALOS

Koda	Ogrevanje	Dimenzije (cm)	Moč (W)	Cena
<b>HALOS</b>	do 18m <sup>2</sup>	47,5 x 79 x 10	1500	<b>279,38</b>

Možnost stenske montaže. Napetost 230V. Zaščita proti vlagi IP24. Teža 9kg.